

UltraScale and UltraScale+ FPGAs Packaging and Pinouts

Product Specification

UG575 (v1.12) March 20, 2019



Revision History

The following table shows the revision history for this document.

Date	Version	Revision
03/20/2019	1.12	<p>Chapter 1: Added an Important note about XQ devices with eutectic BGA balls on page 17. Added the XQKU5P (FFRB676, SFRB784), XQKU15P (FFRA1156, FFRE1517), XQVU3P (FFRC1517), XQVU7P (FLRA2104, FLRB2104), and XQVU11P (FLRC2104) device/package combinations to Table 1-1, Table 1-2, Table 1-4, Table 1-6, Table 1-7, Table 1-8, Table 1-8, and the appropriate figures in the Device Diagrams section. In Table 1-5, corrected D[04 to 31] configuration data pins label and added note to VCCAUX_IO. Revised the XCVU31P Bank Diagrams, XCVU33P Bank Diagrams, XCVU35P Bank Diagrams, XCVU37P Bank Diagrams and to show the correct PCIE4 and PCIE4C banks. Added the XCVU27P (FIGD2104, FSGA2577) and XCVU29P (FIGD2104, FSGA2577) devices. This includes adding Table 1-3 and updates to Table 1-1, Table 1-4, Table 1-5, Table 1-6, Table 1-7, Table 1-8, and the appropriate figures in the Device Diagrams section. Updated the XCVU27P Bank Diagrams.</p> <p>Chapter 2: Added an Important note about XQ devices with eutectic BGA balls on page 173. In Table 2-1, added the XCVU27P (FIGD2104, FSGA2577) and XCVU29P (FIGD2104, FSGA2577) devices and the XQKU5P (FFRB676, SFRB784), XQKU15P (FFRA1156, FFRE1517), XQVU3P (FFRC1517), XQVU7P (FLRA2104, FLRB2104), and XQVU11P (FLRC2104) device/package combinations.</p> <p>Chapter 3: Added an Important note about XQ devices with eutectic BGA balls on page 177. In Table 3-3, added the XQKU5P (FFRB676, SFRB784), XQKU15P (FFRA1156, FFRE1517) device/package combinations. In Table 3-4, added the XCVU27P (FIGD2104, FSGA2577), XCVU29P (FIGD2104, FSGA2577), XQVU3P (FFRC1517), XQVU7P (FLRA2104, FLRB2104), and XQVU11P (FLRC2104) device/package combinations.</p> <p>Chapter 4: Added to the Summary information on XQ devices with eutectic BGA balls and updated Table 4-1 with the packages specific to the XQ versions. In Table 4-1, added the mechanical drawings for the XQKU5P (FFRB676, SFRB784), XQKU15P (FFRA1156, FFRE1517), XQVU3P (FFRC1517), XQVU7P (FLRA2104, FLRB2104), and XQVU11P (FLRC2104), and updated the FIGD2104 and FSGA2577 drawings to add the XCVU27P and XCVU29P.</p> <p>Chapter 5: Added Figure 5-5 and updated Table 5-1.</p> <p>Chapter 6: Updated Table 6-1 with the FSGA2577 package and the XQ packages (FFRB676, SFRB784, FFRA1156, FFRC1517, FFRE1517, FLRA2104, FLRB2104, FLRC2104). Added an Important note about XQ devices with eutectic BGA balls on page 409.</p> <p>Chapter 7: Updated the Sn/Pb reflow soldering guidelines including changes to Figure 7-2. Added the FSGA2577 package and the XQ packages (FFRB676, SFRB784, FFRA1156, FFRC1517, FFRE1517, FLRA2104, FLRB2104, FLRC2104) to Table 7-2 and added Note 2. Updated the Conformal Coating section.</p> <p>Chapter 9: Added an Important note about XQ devices with eutectic BGA balls on page 419. Updated Table 9-1 with new data.</p>

Date	Version	Revision
01/08/2019	1.12 (cont'd)	<p>Chapter 9: Although the same information was already in Note 2 at the end of Table 9-1, it is repeated in an additional Important note on page 418. Added an Important note about XQ devices with eutectic BGA balls on page 419. In Table 9-1, revised FFVE900 values, added the XCVU27P (FIGD2104, FSGA2577), XCVU29P (FIGD2104, FSGA2577), XQKU5P (FFRB676, SFRB784), XQKU15P (FFRA1156, FFRE1517), XQVU3P (FFRC1517), XQVU7P (FLRA2104, FLRB2104), and XQVU11P (FLRC2104) device/package data. Also added data to the XCVU31P, XCVU33P, XCVU35P, and XCVU37P devices.</p> <p>Chapter 10: Updated applied pressure range in Recommended note on page 428 to 20–50 psi.</p>
8/23/2018	1.11	<p>Chapter 1: In Table 1-5, updated the GC or HDGC direction to Input/Output. In Table 1-8, updated the XCVU160-FLGB2104 map to change the 233 quad location and added the 233 and 133 quads to XCVU160-FLGC2104 map.</p> <p>Chapter 2: In Table 2-1, updated the XCVU31P-FSVH1924, XCVU33P/XCVU35P-FSVH2104, XCVU13P-FSGA2577, and XCVU35P/XCVU37P-FSVH2892 to production and revised the links.</p> <p>Chapter 3: In Table 3-4, updated the XCVU31P-FSVH1924, XCVU33P/XCVU35P-FSVH2104, XCVU13P-FSGA2577, and XCVU35P/XCVU37P-FSVH2892 to production.</p> <p>Chapter 4: In Table 4-1, updated the mechanical drawing status for XCVU31P-FSVH1924, XCVU33P/XCVU35P-FSVH2104, XCVU13P-FSGA2577, and XCVU35P/XCVU37P-FSVH2892 to production.</p> <p>Chapter 9: In Table 9-1, added the XCVU31P-FSVH1924, XCVU33P/XCVU35P-FSVH2104, XCVU13P-FSGA2577, and XCVU35P/XCVU37P-FSVH2892 devices.</p>
4/09/2018	1.10	<p>Chapter 1: Updated the Bank Locations of Dedicated and Multi-Function Pins section. Added the XCVU13P-FSGA2577 device/package combination and the XCVU31P, XCVU33P, XCVU35P, and XCVU37P devices. This includes updates to Table 1-1, Table 1-2, Table 1-4, Table 1-5, Table 1-6, Table 1-7, and Table 1-8. Added Figure 1-122, Figure 1-123, Figure 1-124, Figure 1-125, Figure 1-126, Figure 1-127, Figure 1-128, Figure 1-129, and Figure 1-130.</p> <p>Chapter 2: Added the XCVU13P-FSGA2577 device/package combination and the XCVU31P, XCVU33P, XCVU35P, and XCVU37P devices to Table 2-1.</p> <p>Chapter 3: Added the XCVU13P-FSGA2577 device/package combination and the XCVU31P, XCVU33P, XCVU35P, and XCVU37P devices to Table 3-4.</p> <p>Chapter 4: Added the XCVU13P-FSGA2577 device/package combination and the XCVU31P, XCVU33P, XCVU35P, and XCVU37P devices to Table 4-1.</p> <p>Chapter 6: Added the FSVH1924, FSVH2104, FSGA2577, and FSVH2892 packages to Table 6-1.</p> <p>Chapter 7: Added the FSVH1924, FSVH2104, FSGA2577, and FSVH2892 packages to Table 7-2.</p> <p>Chapter 9: Added the XCVU13P-FSGA2577 device/package combination and the XCVU31P, XCVU33P, XCVU35P, and XCVU37P devices to Table 9-1.</p> <p>Chapter 12: Added a link to <i>Mechanical and Thermal Design Guidelines for Lidless Flip-Chip Packages Application Note</i> (XAPP1301).</p>

Date	Version	Revision
12/15/2017	1.9	<p>Chapter 2, Package Files: Updated links and package designations in Table 2-1.</p> <p>Chapter 3, Device Diagrams: Updated package designations in Table 3-3 and Table 3-4. Added Figure 3-85, Figure 3-86, Figure 3-133, and Figure 3-134.</p> <p>Chapter 4, Mechanical Drawings: Updated package designations in Table 4-1. Added Figure 4-45. Updated Figure 4-46 (the dimensions inside the Top View changed). Added Figure 4-47.</p> <p>Chapter 9, Thermal Specifications: Added Note 2 to Table 9-1.</p> <p>Chapter 10, Thermal Management Strategy updated the System Level Heat Sink Solutions and Heat Sink Removal sections. Added the Measurement Debug section.</p> <p>Chapter 12, Mechanical and Thermal Design Guidelines for Lidless Flip-chip Packages was added to user guide.</p>
8/25/2017	1.8	<p>Chapter 1, Packaging Overview: In Table 1-4, corrected (increased) the available HP I/O pin counts for the XCKU095-FFVB2104. In Table 1-5, revised the VCCINT_IO description. In Table 1-7, updated the XCKU5P-FFVB676 mapping and added the XCKU095-FFVC1517. Added at Tip on page 57. Updated bank designations in Figure 1-8, Figure 1-13, Figure 1-15, Figure 3-92, Figure 1-28, Figure 1-32, Figure 1-35, all XCVU080 Bank Diagrams, XCVU095 Bank Diagrams, Figure 1-52, XCKU9P Bank Diagrams, Figure 1-79, XCKU13P Bank Diagrams, and XCKU15P and XQKU15P Bank Diagrams.</p> <p>Chapter 2, Package Files: Updated links and package designations in Table 2-1.</p> <p>Chapter 3, Device Diagrams: Updated package designations in Table 3-3 and Table 3-4. Added Figure 3-91 and Figure 3-92. Updated Figure 3-95 and Figure 3-96. Added Figure 3-113, Figure 3-114, Figure 3-127, Figure 3-128, Figure 3-135, and Figure 3-136.</p> <p>Chapter 4, Mechanical Drawings: Updated package designations in Table 4-1.</p> <p>Chapter 5, Package Marking: Updated the Top Marks for Figure 5-1 and Figure 5-2 to show the date code and lot number on the bar code version. Added package types to Table 5-1.</p> <p>Chapter 6, Packing and Shipping: Added package types to Table 6-1.</p> <p>Chapter 7, Soldering Guidelines: Added guidelines for lidless packages with stiffener ring and updated Table 7-1. Revised the Mass Reflow from 250°C to 245°C on a number of package types in Table 7-2. Revised Figure 7-2 with new guidelines.</p> <p>Chapter 9, Thermal Specifications: Added package types to Table 9-1.</p> <p>Added Documentation Navigator and Design Hubs in Appendix A.</p>
4/27/2017	1.7.1	<p>Replaced the FFVE1760 (XCKU15P) figures in Chapter 3, Device Diagrams.</p>

Date	Version	Revision
4/26/2017	1.7	<p>Added the XQKU040, XQKU060, XQKU095, and XQKU115 devices where applicable. Added the RBA676, RFA1156, RLD1517, and RLF1924 packages where applicable.</p> <p>Chapter 1, Packaging Overview: Updated Note 5 in Table 1-5. Revised Table 1-6, Table 1-7, and Table 1-8. Added notes and recommendations to the SYSMON, Configuration, PCIe, Interlaken, and 100GE Integrated Blocks section. Revised many of the Device Diagrams.</p> <p>Chapter 2, Package Files: Updated the links. Added and updated package files for Virtex UltraScale+ and Kintex UltraScale+ FPGAs.</p> <p>Chapter 3, Device Diagrams: Added and updated diagrams for Virtex UltraScale+ and Kintex UltraScale+ FPGAs.</p> <p>Chapter 4, Mechanical Drawings: Added and replaced many of the mechanical drawings for the Virtex UltraScale+ and Kintex UltraScale+ devices.</p> <p>Chapter 5, Package Marking: Updated the Virtex UltraScale and Kintex UltraScale device top-mark diagrams to include the bar code top-mark diagrams. Added the Virtex UltraScale+ and Kintex UltraScale+ device top-mark diagrams.</p> <p>Chapter 7, Soldering Guidelines: Added the Sn/Pb Reflow Soldering section. Updated the Conformal Coating recommendation.</p>
4/25/2016	1.6	<p>Added Kintex UltraScale+ and Virtex UltraScale+ FPGAs.</p> <p>Chapter 1, Packaging Overview: Revised GC or HDGC description and added RSVDGND to Table 1-5. Revised the Die Level Bank Numbering Overview section including adding and replacing figures and removing tables.</p> <p>Chapter 2, Package Files: Updated the links.</p> <p>Chapter 3, Device Diagrams: Corrected Figure 3-7 and Figure 3-8.</p> <p>Chapter 4, Mechanical Drawings: Updated top-lid flat-surface dimension from 31.05 sq. max. to 29.70sq. max. in Figure 4-12 (FFVA1156). Updated the top-lid flat-surface dimension from 29.10 max. to 29.70 sq. max. in Figure 4-13 (FFVA1156) and Figure 4-14 (FFVA1156). Added top-lid flat-surface dimension 33.10 in Figure 4-18 (FFVA1517). Update dimension A nominal from 3.61 to 3.51 in Figure 4-24 (FFVB1760). Updated Figure 4-38 (FLGB2104) to add a missing decimal point. Updated Figure 4-41 (FFVC2104) with the correct package dimensions.</p> <p>Chapter 7, Soldering Guidelines: Updated the device list in Table 7-2.</p> <p>Chapter 10, Thermal Management Strategy: Added a new recommendation and Figure 10-2.</p>

Date	Version	Revision
10/19/2015	1.5	<p>Added the XCKU025 and the XCKU095 in the FFVA1156 package.</p> <p>In Chapter 1, Packaging Overview, updated SFVA784 package in Table 1-7, Table 1-9 and Table 1-10. Updated the FLVB1760 rows in Table 1-8. Added an important note in Footprint Compatibility between Packages. Replaced Figure 1-13.</p> <p>In Chapter 3, Device Diagrams, replaced the SFVA784 drawings in Figure 3-3 and Figure 3-4 with updated pinouts. Updated Figure 3-43 and Figure 3-44.</p> <p>In Chapter 4, Mechanical Drawings, updated Figure 4-6 (SFVA784) and Figure 4-13 (FFVA1156), and corrected the heading for Figure 4-38 to include FLGB2104 and FLGC2104. Replaced Figure 4-38, Figure 4-50, Figure 4-51, and Figure 4-55.</p> <p>In Chapter 8, Recommended PCB Design Rules for BGA Packages, updated Table 8-1.</p> <p>In Chapter 9, Thermal Specifications, added thermal resistance data to Table 9-1. Substantial edits to the Introduction, Thermal Resistance Data, and Support for Thermal Models sections. Added a new recommendation on page 423.</p> <p>In Chapter 10, Thermal Management Strategy, removed <i>Design and Silicon</i> section, updated the Flip-Chip Packages and System Level Heat Sink Solutions sections, removed the <i>Thermal Management Options</i> section, added more information to Types of TIM, removed the <i>Comparing the Types of Interface Materials</i> section, added the Applied Pressure from Heat Sink to the Package via Thermal Interface Materials section, and removed the <i>Package Pressure Handling Capacity</i> section.</p> <p>In Chapter 11, Heat Sink Guidelines for Bare-die Flip-Chip Packages, removed the <i>Package Loading Specifications</i> section.</p>
5/13/2015	1.4	<p>Added the XCKU035 and XCKU040 devices in the SFVA784 package throughout this guide. Added XCKU085 and XCKU095 updates throughout including Table 1-7, Table 1-8, and Table 3-1.</p> <p>In Chapter 1, Packaging Overview, in Table 1-5 changed D01_DIN_0, D02_0, and D03_0 to bidirectional. Updated Figure 1-9 to Figure 1-14 with new GTH Quad placements.</p> <p>In Chapter 4, Mechanical Drawings, updated Table 4-1 and the specific mechanical drawings of the SFVA784, FBVA900, FLVA1517, FLVD1517, FLVB1760, FLVA2104, FLVB2104, FLGB2104, FFVC2104, FLVC2104, and FLGC2104.</p>
3/23/2015	1.3	<p>Updated the Differences from Previous Generations section. In Table 1-5, updated VCCINT and VCCAUX descriptions and the Multi-gigabit Serial Transceiver Pins (GTHE3 and GTYE3) section. Updated the Die Level Bank Numbering Overview section including adding the SYSMON, Configuration, PCIe, Interlaken, and 100GE Integrated Blocks section. Replaced Figure 1-4 through Figure 1-62 and updated information in Table 1-9 through Table 1-21. Removed the XCKU075 and XCKU100 throughout. Added the XCKU085 and XCKU095 where data is available.</p> <p>In Chapter 2, Package Files, updated the links to the ASCII files.</p> <p>In Chapter 3, Device Diagrams, updated Figure 3-13, Figure 3-14 and added numerous new figures.</p> <p>In Chapter 4, Mechanical Drawings, removed the FBVA900 mechanical drawings and updated Figure 4-21.</p> <p>In Chapter 5, Package Marking, added to the 2nd line description in Table 5-1.</p> <p>Revised Table 9-1.</p>

Date	Version	Revision
1/12/2015	1.2	<p>Revised the device/package combinations per the update to the <i>UltraScale Architecture and Product Overview</i> (DS890) [Ref 1]. This revision was throughout the guide in every table with package listings, Package Files, Device Diagrams, and Mechanical Drawings.</p> <p>Updated Table 1-16, Table 1-17, and replaced Table 1-18, Table 1-19, and Table 1-20.</p> <p>Updated descriptions in Table 5-1.</p> <p>Updated descriptions in Table 7-2.</p> <p>Revised and added to Table 9-1.</p> <p>Added references to Appendix A.</p>
9/04/2014	1.1	<p>Added a discussion on ULA materials on page 15. In Differences from Previous Generations, updated the differential clock pin pairs and the VREF pin discussion. Added the Virtex UltraScale FPGA packages to Table 1-1. Also added the Virtex UltraScale devices to Table 1-2, Table 1-4, and Table 1-6. Updated PERSTN[0 to 1], DOUT_CSO_B, FWE_FCS2_B, RS[0 to 1], RDWR_FCS_B_0, D00_MOSI_0, D01_DIN_0, and VREF_[bank number] descriptions. Updated Multi-gigabit Serial Transceiver Pins (GTHE3 and GTYE3) pin names. Added Table 1-7 and Table 1-8. Revised the T[0 to 3][U or L] and N[0 to 12] descriptions in the User I/O Pins section of Table 1-5: Pin Definitions. Updated the figures and added tables to the Die Level Bank Numbering Overview section.</p> <p>Changed the TXT and CSV files associated with Table 2-1. Also updated Table 2-1 with additional device/packages and links.</p> <p>In Chapter 3, Device Diagrams, replaced or added figures.</p> <p>Added Figure 4-1 through Figure 4-4. Replaced Figure 4-12 and Figure 4-13. Added Figure 4-18 through Figure 4-13.</p> <p>Added the Virtex UltraScale device package marking template to Chapter 5.</p> <p>Clarified the maximum reflow soldering guidelines on page 410 and updated Table 7-2: Peak Package Reflow Body Temperature(1). Replaced Figure 7-2. Removed the <i>Sn/Pb Reflow Soldering</i> section from Chapter 7, Soldering Guidelines. Added Post Reflow/Cleaning/Washing and Conformal Coating sections.</p> <p>Updated Thermal Management Options and Figure 10-2. Added Heat Sink Removal and Package Pressure Handling Capacity to Chapter 10.</p> <p>Updated the links to references [Ref 21], [Ref 22], and [Ref 23] in Appendix A. Added further references.</p>
12/10/2013	1.0	Initial Xilinx release.

Table of Contents

Revision History	2
Chapter 1: Packaging Overview	
Introduction to the UltraScale Architecture	14
Introduction to UltraScale and UltraScale+ FPGAs Packaging and Pinouts	15
Differences from Previous Generations	16
Device/Package Combinations	17
Gigabit Transceiver Channels by Device/Package	19
User I/O Pins by Device/Package	24
Pin Definitions	28
Footprint Compatibility between Packages	35
Die Level Bank Numbering Overview	55
Chapter 2: Package Files	
About ASCII Package Files	171
Package Specifications Designations	172
ASCII Pinout Files	173
Chapter 3: Device Diagrams	
Summary	177
FBVA676 Package–XCKU035 and XCKU040 and RBA676 Package–XQKU040	183
SFVA784 (XCKU035 and XCKU040)	185
FBVA900 (XCKU035 and XCKU040)	187
FFVA1156 (XCKU025)	189
FFVA1156 (XCKU035)	191
FFVA1156 (XCKU040) and RFA1156 (XQKU040)	193
FFVA1156 (XCKU060) and RFA1156 (XQKU060)	195
FFVA1156 (XCKU095) and RFA1156 (XQKU095)	197
FFVA1517 (XCKU060)	199
FLVA1517 (XCKU085 and XCKU115)	201
FFVC1517 (XCKU095)	203
FLVD1517 (XCKU115) and RLD1517 (XQKU115)	205
FFVB1760 (XCKU095)	207

FLVB1760 (XCKU085)	209
FLVB1760 (XCKU115)	211
FLVD1924 (XCKU115)	213
FLVF1924 (XCKU085)	215
FLVF1924 (XCKU115) and RLF1924 (XQKU115)	217
FLVA2104 (XCKU115)	219
FFVB2104 (XCKU095)	221
FLVB2104 (XCKU115)	223
FFVC1517 (XCVU065)	225
FFVC1517 (XCVU080 and XCVU095)	227
FFVD1517 (XCVU080 and XCVU095)	229
FLVD1517 (XCVU125)	231
FFVB1760 (XCVU080 and XCVU095)	233
FLVB1760 (XCVU125)	235
FFVA2104 (XCVU080 and XCVU095)	237
FLVA2104 (XCVU125)	239
FFVB2104 (XCVU080 and XCVU095)	241
FLVB2104 (XCVU125)	243
FLGB2104 (XCVU160 and XCVU190)	245
FFVC2104 (XCVU095)	247
FLVC2104 (XCVU125)	249
FLGC2104 (XCVU160 and XCVU190)	251
FLGB2377 (XCVU440)	253
FLGA2577 (XCVU190)	255
FLGA2892 (XCVU440)	257
FFVA676 (XCKU3P and XCKU5P)	259
FFVB676 (XCKU3P and XCKU5P) and FFRB676 (XQKU5P)	261
SFVB784 (XCKU3P and XCKU5P) and SFRB784 (XQKU5P)	263
FFVD900 (XCKU3P and XCKU5P)	265
FFVD900 (XCKU11P)	267
FFVE900 (XCKU9P)	269
FFVE900 (XCKU13P)	271
FFVA1156 (XCKU11P)	273
FFVA1156 (XCKU15P) and FFRA1156 (XQKU15P)	275
FFVE1517 (XCKU11P)	277
FFVE1517 (XCKU15P) and FFRE1517 (XQKU15P)	279
FFVA1760 (XCKU15P)	281
FFVE1760 (XCKU15P)	283
FFVC1517 (XCVU3P) and FFRC1517 (XQVU3P)	285
FLGF1924 (XCVU11P)	287

FSVH1924 (XCVU31P)	289
FLVA2104 (XCVU5P and XCVU7P) and FLRA2104 (XQVU7P)	291
FLGA2104 (XCVU9P)	293
FHGA2104 (XCVU13P)	295
FLVB2104 (XCVU5P and XCVU7P) and FLRB2104 (XQVU7P)	297
FLGB2104 (XCVU9P)	299
FLGB2104 (XCVU11P)	301
FHGB2104 (XCVU13P)	303
FLVC2104 (XCVU5P and XCVU7P)	305
FLGC2104 (XCVU9P)	307
FLGC2104 (XCVU11P) and FLRC2104 (XQVU11P)	309
FHGC2104 (XCVU13P)	311
FSGD2104 (XCVU9P)	313
FSGD2104 (XCVU11P)	315
FIGD2104 (XCVU13P)	317
FIGD2104 (XCVU27P)	319
FIGD2104 (XCVU29P)	321
FSVH2104 (XCVU33P)	323
FSVH2104 (XCVU35P)	325
FLGA2577 (XCVU9P)	327
FLGA2577 (XCVU11P)	329
FLGA2577 and FSGA2577 (XCVU13P)	331
FSGA2577 (XCVU27P)	333
FSGA2577 (XCVU29P)	335
FSVH2892 (XCVU35P)	337
FSVH2892 (XCVU37P)	339

Chapter 4: Mechanical Drawings

Summary	341
FBVA676 Bare-die Flip-Chip, Fine-Pitch BGA (XCKU035 and XCKU040)	345
FFVA676 and FFVB676 Flip-Chip, Fine-Pitch BGA (XCKU3P and XCKU5P)	347
FFRB676 Ruggedized Flip-Chip, Fine-Pitch BGA (XQKU5P)	348
RBA676 Ruggedized Flip-Chip, Fine-Pitch BGA (XQKU040)	349
SFVA784 Flip-Chip, Chip-Scale (0.8 mm) BGA (XCKU035 and XCKU040)	350
SFVB784 Flip-Chip, Super-Fine Pitch (0.8 mm) BGA (XCKU3P and XCKU5P)	351
SFRB784 Ruggedized Flip-Chip, Super Fine-Pitch BGA (XQKU5P)	352

FBVA900 Bare-die Flip-Chip, Fine-Pitch BGA (XCKU035 and XCKU040)	353
FFVD900 (XCKU3P, XCKU5P, and XCKU11P) and FFVE900 (XCKU9P and XCKU13P)	355
FFVA1156 Flip-Chip, Fine-Pitch BGA (XCKU025, XCKU035, and XCKU040)	356
FFVA1156 Flip-Chip, Fine-Pitch BGA (XCKU060, XCKU095, and XCKU11P)	357
FFVA1156 Flip-Chip, Fine-Pitch BGA (XCKU15P)	358
FFRA1156 Ruggedized Flip-Chip, Fine-Pitch BGA (XQKU15P)	359
RFA1156 Ruggedized Flip-Chip, Fine-Pitch BGA (XQKU040)	360
RFA1156 Ruggedized Flip-Chip, Fine-Pitch BGA (XQKU060 and XQKU095)	361
FFVA1517, FFVC1517, and FFVD1517 Flip-Chip, Fine-Pitch BGA (XCKU060, XCKU095, XCVU065, XCVU080, XCVU095)	362
FFVC1517 (XCVU3P) and FFVE1517 (XCKU11P and XCKU15P) Flip-Chip, Fine-Pitch BGA	363
FFRC1517 (XQVU3P) and FFRE1517 (XQKU15P) Ruggedized Flip-Chip, Fine-Pitch BGA	364
FLVA1517 (XCKU085 and XCKU115) and FLVD1517 (XCKU115 and XCVU125) Flip-Chip, Fine-Pitch BGA	365
RLD1517 Ruggedized Flip-Chip, Fine-Pitch BGA (XQKU115)	366
FFVA1760 Flip-Chip, Fine-Pitch BGA (XCKU15P)	367
FFVB1760 Flip-Chip, Fine-Pitch BGA (XCKU095, XCVU080, and XCVU095)	368
FLVB1760 Flip-Chip, Fine-Pitch BGA (XCKU085, XCKU115, and XCVU125)	369
FFVE1760 Flip-Chip, Fine-Pitch BGA (XCKU15P)	370
FLVD1924 (XCKU115) and FLVF1924 (XCKU085 and XCKU115) Flip-Chip, Fine-Pitch BGA	371
FLGF1924 (XCVU11P) Flip-Chip, Fine-Pitch BGA	372
RLF1924 (XQKU115) Ruggedized Flip-Chip, Fine-Pitch BGA	373
FSVH1924 (XCVU31P) Flip-Chip, Fine-Pitch, Lidless with Stiffener Ring, BGA	374
FFVA2104 (XCVU080 and XCVU095) and FFVB2104 (XCKU095, XCVU080, and XCVU095) Flip-Chip, Fine-Pitch BGA	375
FHGA2104 (XCVU13P) Flip-Chip, Fine-Pitch BGA	376
FHGB2104 (XCVU13P) and FHGC2104 (XCVU13P) Flip-Chip, Fine-Pitch BGA	377
FLVA2104 (XCKU115 and XCVU125) and FLVB2104 (XCKU115 and XCVU125) Flip-Chip, Fine-Pitch BGA	378
FLVA2104 (XCVU5P and XCVU7P) and FLVB2104 (XCVU5P and XCVU7P) Flip-Chip, Fine-Pitch BGA . . 379	
FLRA2104 (XQVU7P) and FLRB2104 (XQVU7P) Ruggedized Flip-Chip, Fine-Pitch BGA	380
FLGA2104 (XCVU9P) Flip-Chip, Fine-Pitch BGA	381
FLGB2104 (XCVU160 and XCVU190) and FLGC2104 (XCVU160 and XCVU190) Flip-Chip, Fine-Pitch BGA	382
FLGB2104 (XCVU9P and XCVU11P) and FLGC2104 (XCVU11P) Flip-Chip, Fine-Pitch BGA	383

FLRC2104 (XQVU11P) Ruggedized Flip-Chip, Fine-Pitch BGA	384
FFVC2104 (XCVU095) Flip-Chip, Fine-Pitch BGA	385
FLGC2104 (XCVU9P) Flip-Chip, Fine-Pitch BGA	386
FLVC2104 (XCVU125) Flip-Chip, Fine-Pitch BGA	387
FLVC2104 (XCVU5P and XCVU7P) Flip-Chip, Fine-Pitch BGA	388
FIGD2104 (XCVU13P, XCVU27P, and XCVU29P) Flip-Chip, Fine-Pitch BGA	389
FSGD2104 (XCVU9P) Flip-Chip, Fine-Pitch BGA	390
FSGD2104 (XCVU11P) Flip-Chip, Fine-Pitch BGA	391
FSVH2104 (XCVU33P) Flip-Chip, Fine-Pitch, Lidless with Stiffener Ring, BGA	392
FSVH2104 (XCVU35P) Flip-Chip, Fine-Pitch, Lidless with Stiffener Ring, BGA	393
FLGB2377 Flip-Chip, Fine-Pitch BGA (XCVU440)	394
FLGA2577 Flip-Chip, Fine-Pitch BGA (XCVU190)	395
FLGA2577 Flip-Chip, Fine-Pitch BGA (XCVU9P and XCVU13P)	396
FLGA2577 Flip-Chip, Fine-Pitch BGA (XCVU11P)	397
FSGA2577 Flip-Chip, Fine-Pitch BGA (XCVU13P, XCVU27P, and XCVU29P)	398
FLGA2892 Flip-Chip, Fine-Pitch BGA (XCVU440)	399
FSVH2892 (XCVU35P) Flip-Chip, Fine-Pitch, Lidless with Stiffener Ring, BGA	400
FSVH2892 (XCVU37P) Flip-Chip, Fine-Pitch, Lidless with Stiffener Ring, BGA	401
Chapter 5: Package Marking	
Introduction	402
Chapter 6: Packing and Shipping	
Introduction	408
Chapter 7: Soldering Guidelines	
Soldering Guidelines	410
Chapter 8: Recommended PCB Design Rules for BGA Packages	
BGA Packages	416
Chapter 9: Thermal Specifications	
Introduction	418
Thermal Resistance Data	418
Support for Thermal Models	423
Chapter 10: Thermal Management Strategy	
Introduction	424
Thermal Interface Material	425
Heat Sink Removal	429

Measurement Debug	431
Chapter 11: Heat Sink Guidelines for Bare-die Flip-Chip Packages	
Heat Sink Attachments for Bare-die FB Packages	432
Types of Heat Sink Attachments	433
Chapter 12: Mechanical and Thermal Design Guidelines for Lidless Flip-chip Packages	
Introduction	438
Lidless Flip-Chip Packages	438
Appendix A: Additional Resources and Legal Notices	
Xilinx Resources	440
Solution Centers	440
Documentation Navigator and Design Hubs	440
References	441
Please Read: Important Legal Notices	443

Packaging Overview

Introduction to the UltraScale Architecture

The Xilinx® UltraScale™ architecture is the first ASIC-class architecture to enable multi-hundred gigabit-per-second levels of system performance with smart processing, while efficiently routing and processing data on-chip. UltraScale architecture-based devices address a vast spectrum of high-bandwidth, high-utilization system requirements by using industry-leading technical innovations, including next-generation routing, ASIC-like clocking, 3D-on-3D ICs, multiprocessor SoC (MPSoC) technologies, and new power reduction features. The devices share many building blocks, providing scalability across process nodes and product families to leverage system-level investment across platforms.

Virtex® UltraScale+™ devices provide the highest performance and integration capabilities in a FinFET node, including both the highest serial I/O and signal processing bandwidth, as well as the highest on-chip memory density. As the industry's most capable FPGA family, the Virtex UltraScale+ devices are ideal for applications including 1+Tb/s networking and data center and fully integrated radar/early-warning systems.

Virtex UltraScale devices provide the greatest performance and integration at 20 nm, including serial I/O bandwidth and logic capacity. As the industry's only high-end FPGA at the 20 nm process node, this family is ideal for applications including 400G networking, large scale ASIC prototyping, and emulation.

Kintex® UltraScale+ devices provide the best price/performance/watt balance in a FinFET node, delivering the most cost-effective solution for high-end capabilities, including transceiver and memory interface line rates as well as 100G connectivity cores. Our newest mid-range family is ideal for both packet processing and DSP-intensive functions and is well suited for applications including wireless MIMO technology, Nx100G networking, and data center.

Kintex UltraScale devices provide the best price/performance/watt at 20 nm and include the highest signal processing bandwidth in a mid-range device, next-generation transceivers, and low-cost packaging for an optimum blend of capability and cost-effectiveness. The family is ideal for packet processing in 100G networking and data centers applications as well as DSP-intensive processing needed in next-generation medical imaging, 8k4k video, and heterogeneous wireless infrastructure.

Zynq® UltraScale+ MPSoC devices provide 64-bit processor scalability while combining real-time control with soft and hard engines for graphics, video, waveform, and packet processing. Integrating an Arm®-based system for advanced analytics and on-chip programmable logic for task acceleration creates unlimited possibilities for applications including 5G Wireless, next generation ADAS, and Industrial Internet-of-Things.

This packaging and pinout specification user guide is part of the UltraScale Architecture documentation suite available at: www.xilinx.com/ultrascale.

Introduction to UltraScale and UltraScale+ FPGAs Packaging and Pinouts

This section describes the packages and pinouts for the UltraScale architecture-based FPGAs in various organic flip-chip 0.8 mm and 1.0 mm pitch BGA packages.

- Kintex UltraScale and Kintex UltraScale+ devices are offered in low-cost, space-saving flip-chip and bare-die flip-chip packages that are optimally designed for high performance-to-price ratio.
- Virtex UltraScale and Virtex UltraScale+ devices are offered exclusively in high performance flip-chip BGA packages that are optimally designed for highest system capacity, bandwidth and signal performance. Package inductance is minimized as a result of optimal placement and even distribution as well as an increased number of power and GND pins.
- Zynq UltraScale+ MPSoCs are further described in the *Zynq UltraScale+ MPSoC Packaging and Pinouts User Guide* (UG1075) [Ref 4].



IMPORTANT: *Many of the standard packages for commercial (XC) devices are lead-free (signified by an additional V in the package name). All of the UltraScale or UltraScale+ devices supported in a particular package are footprint compatible. Each device is split into I/O banks to allow for flexibility in the choice of I/O standards. See the UltraScale Architecture SelectIO Resources User Guide (UG571) [Ref 5].*

UltraScale and UltraScale+ device's flip-chip assembly materials are manufactured using ultra-low alpha (ULA) materials defined as <0.002 cph/cm² or materials that emit less than 0.002 alpha-particles per square centimeter per hour.

Differences from Previous Generations

The packaging and pinout specifications for UltraScale architecture-based FPGAs differ from past generations, including the 7 series devices. These details are outlined in this section.

- All packages are constructed on organic laminate substrates.
- Many of the package and die components, including flip-chip solder bumps, are lead-free. The FLGx devices have lead in their bumps.
- Package names contain a single-character alphabetic designator followed by the exact number of pins found on the package.
- VCCAUX_IO pins are not divided into bank groups. VCCAUX_IO must be connected to VCCAUX at the board level.
- Internal logic is separated from I/O logic by the addition of the VCCINT_IO power pins. VCCINT_IO must be connected to VCCINT at the board level.
- Groups of gigabit serial transceiver (GT) power pins are separated by column for each column of GT Quads/Duals.
- Standard I/O banks each have a total of 52 SelectIO™ pins, optionally configurable as up to 24 differential pairs.
- Each bank has one dedicated VREF pin. These pins cannot be used as user I/Os.
- Four differential clock pin pairs per bank (two per 26-pin bank) consist of a single type of global clock (GC) input.
- Four memory byte groups per I/O bank (two per 26-pin bank) are each separated into an upper and a lower memory byte group.
- All configuration pins are located in bank 0 and bank 65.
- A POR_OVERRIDE pin is used to override the default power-on-reset delay. See [Table 1-5](#).

Device/Package Combinations

Table 1-1 shows the size and BGA pitch of the UltraScale and UltraScale+ device packages. The devices with stacked-silicon interconnect (SSI) technology are labeled.



IMPORTANT: All packages are available with eutectic BGA balls. To order these packages, the device type starts with an XQ vs. XC, and the third digit in the package name is Q (for example: FFQA1156).

Table 1-1: Package Specifications

Packages ⁽¹⁾	Description	Package Specifications		
		Package Type	Pitch (mm)	Size (mm)
FBVA676	Bare-die, flip-chip, fine-pitch	BGA	1.0	27 x 27
FFVA676	Flip-chip, fine-pitch			
FFVB676				
FFRB676	Ruggedized, flip-chip, fine-pitch			
RBA676				
SFVA784	Flip-chip, super-fine-pitch		0.8	23 x 23
SFVB784				
SFRB784	Ruggedized, flip-chip, super-fine pitch			
FBVA900	Bare-die, flip-chip, fine-pitch		1.0	31 x 31
FFVD900	Flip-chip, fine-pitch			
FFVE900				
FFVA1156	Flip-chip, fine-pitch			35 x 35
FFRA1156				
RFA1156	Ruggedized, flip-chip, fine-pitch			
FFVA1517				
FFVC1517	Flip-chip, fine-pitch	40 x 40		
FFVD1517				
FFVE1517	Ruggedized, flip-chip, fine-pitch			
FFRC1517				
FFRE1517	Ruggedized, SSI, flip-chip, fine-pitch			
RLD1517				
FLVA1517	SSI, flip-chip, fine-pitch			
FLVD1517				

Table 1-1: Package Specifications (Cont'd)

Packages ⁽¹⁾	Description	Package Specifications																					
		Package Type	Pitch (mm)	Size (mm)																			
FFVA1760	Flip-chip, fine-pitch	BGA	1.0	42.5 x 42.5																			
FFVB1760																							
FFVE1760																							
FLVB1760	SSI, flip-chip, fine-pitch			BGA	1.0	45 x 45																	
FLGF1924																							
FLVD1924																							
FLVF1924																							
FSVH1924	SSI, flip-chip, fine-pitch, lidless with stiffener ring					BGA	1.0	47.5 x 47.5															
RLF1924	Ruggedized, SSI, flip-chip, fine-pitch																						
FFVA2104	Flip-chip, fine-pitch																						
FFVB2104																							
FFVC2104																							
FLVA2104	SSI, flip-chip, fine-pitch								BGA	1.0	47.5 x 47.5												
FLVB2104																							
FLVC2104																							
FLGA2104	SSI, flip-chip, fine-pitch, RoHS 6/6 with exemption 15										BGA	1.0	47.5 x 47.5										
FLGB2104																							
FLGC2104																							
FLRA2104	Ruggedized, SSI, flip-chip, fine-pitch												BGA	1.0	47.5 x 47.5								
FLRB2104																							
FLRC2104																							
FSGD2104	SSI, flip-chip, fine-pitch, lidless with stiffener ring, RoHS 6/6 with exemption 15														BGA	1.0	47.5 x 47.5						
FSVH2104	SSI, flip-chip, fine-pitch, lidless with stiffener ring																47.5 x 47.5						
FHGA2104 ⁽²⁾	SSI, flip-chip, fine-pitch, overhang, RoHS 6/6 with exemption 15																BGA	1.0	52.5 x 52.5				
FHGB2104 ⁽²⁾																							
FHGC2104 ⁽²⁾																							
FIGD2104 ⁽²⁾	SSI, flip-chip, fine-pitch, overhang, lidless with stiffener ring, RoHS 6/6 with exemption 15																		BGA	1.0	52.5 x 52.5		
FLGB2377	SSI, flip-chip, fine-pitch, RoHS 6/6 with exemption 15																				50 x 50		
FLGA2577	SSI, flip-chip, fine-pitch, RoHS 6/6 with exemption 15																				52.5 x 52.5		
FSGA2577	SSI, flip-chip, fine-pitch, lidless with stiffener ring, RoHS 6/6 with exemption 15																				BGA	1.0	52.5 x 52.5

Table 1-1: Package Specifications (Cont'd)

Packages ⁽¹⁾	Description	Package Specifications		
		Package Type	Pitch (mm)	Size (mm)
FLGA2892	SSI, flip-chip, fine-pitch, RoHS 6/6 with exemption 15	BGA	1.0	55 x 55
FSVH2892	SSI, flip-chip, fine-pitch, lidless with stiffener ring			55 x 55

Notes:

1. FFV, FLV, and FLG packages are footprint compatible when the package code letter designator and pin count are identical. See *UltraScale Architecture and Product Overview* (DS890) [Ref 1] for specific letter codes and ordering code information.
2. These 52.5 x 52.5 packages have the same PCB ball footprint as the 47.5 x 47.5 packages and are footprint compatible.

Gigabit Transceiver Channels by Device/Package

Table 1-2 lists the quantity of gigabit transceiver channels for the UltraScale and UltraScale+ devices. In all devices, a gigabit transceiver channel is one set of MGTRXP, MGTRXN, MGTTXP, and MGTTXN pins. For transceiver data rate limitations on specific device/package combinations, see the specific *UltraScale and UltraScale+ device data sheets* [Ref 3].

Table 1-2: Serial Transceiver Channels (GTH/GTY) by Device/Package

Device	Package	GTH Channels	GTY Channels
Kintex UltraScale Devices			
XCKU035	FBVA676	16	0
XCKU040		16	0
XCKU035	SFVA784	8	0
XCKU040		8	0
XCKU035	FBVA900	16	0
XCKU040		16	0
XCKU025	FFVA1156	12	0
XCKU035		16	0
XCKU040		20	0
XCKU060		28	0
XCKU095		20	8
XCKU060	FFVA1517	32	0
XCKU085	FLVA1517	48	0
XCKU115		48	0
XCKU095	FFVC1517	20	20
XCKU115	FLVD1517	64	0
XCKU095	FFVB1760	32	16

Table 1-2: Serial Transceiver Channels (GTH/GTY) by Device/Package (Cont'd)

Device	Package	GTH Channels	GTY Channels
XCKU085	FLVB1760	44	0
XCKU115		52	0
XCKU115	FLVD1924	52	0
XCKU085	FLVF1924	56	0
XCKU115		64	0
XCKU115	FLVA2104	52	0
XCKU095	FFVB2104	32	32
XCKU115	FLVB2104	64	0
XQKU040	RBA676	16	0
XQKU040	RFA1156	20	0
XQKU060		28	0
XQKU095		20	0
XQKU115	RLD1517	64	0
XQKU115	RLF1924	64	0
Virtex UltraScale Devices			
XCVU065	FFVC1517	20	20
XCVU080		20	20
XCVU095		20	20
XCVU080	FFVD1517	32	32
XCVU095		32	32
XCVU125	FLVD1517	40	32
XCVU080	FFVB1760	32	16
XCVU095		32	16
XCVU125	FLVB1760	36	16
XCVU080	FFVA2104	28	24
XCVU095		28	24
XCVU125	FLVA2104	28	24
XCVU080	FFVB2104	32	32
XCVU095		32	32
XCVU125	FLVB2104	40	36
XCVU160	FLGB2104	40	36
XCVU190		40	36
XCVU095	FFVC2104	32	32
XCVU125	FLVC2104	40	40

Table 1-2: Serial Transceiver Channels (GTH/GTY) by Device/Package (Cont'd)

Device	Package	GTH Channels	GTY Channels
XCVU160	FLGC2104	52	52
XCVU190		52	52
XCVU440	FLGB2377	36	0
XCVU190	FLGA2577	60	60
XCVU440	FLGA2892	48	0
Kintex UltraScale+ Devices			
XCKU3P	FFVA676	0	16
XCKU5P		0	16
XCKU3P	FFVB676	0	16
XCKU5P		0	16
XCKU3P	SFVB784	0	16
XCKU5P		0	16
XCKU3P	FFVD900	0	16
XCKU5P		0	16
XCKU11P	FFVE900	16	0
XCKU9P		28	0
XCKU13P	FFVA1156	28	0
XCKU11P		20	8
XCKU15P	FFVE1517	20	8
XCKU11P		32	20
XCKU15P	FFVA1760	32	24
XCKU15P		44	32
XCKU15P	FFVE1760	32	24
XQKU5P	FFRB676	0	16
XQKU5P	SFRB784	0	16
XQKU15P	FFRA1156	20	8
XQKU15P	FFRE1517	32	24

Table 1-2: Serial Transceiver Channels (GTH/GTY) by Device/Package (Cont'd)

Device	Package	GTH Channels	GTY Channels
Virtex UltraScale+ Devices			
XCVU3P	FFVC1517	0	40
XCVU11P	FLGF1924	0	64
XCVU31P	FSVH1924	0	32
XCVU5P	FLVA2104	0	52
XCVU7P		0	52
XCVU9P	FLGA2104	0	52
XCVU13P	FHGA2104	0	52
XCVU5P	FLVB2104	0	76
XCVU7P		0	76
XCVU9P	FLGB2104	0	76
XCVU11P		0	76
XCVU13P	FHGB2104	0	76
XCVU5P	FLVC2104	0	80
XCVU7P		0	80
XCVU9P	FLGC2104	0	104
XCVU11P		0	96
XCVU13P	FHGC2104	0	104
XCVU9P	FSGD2104	0	76
XCVU11P		0	76
XCVU13P	FIGD2104	0	76
XCVU33P	FSVH2104	0	32
XCVU35P		0	64
XCVU9P	FLGA2577	0	120
XCVU11P		0	96
XCVU13P		0	128
XCVU13P	FSGA2577	0	128
XCVU35P	FSVH2892	0	64
XCVU37P		0	96
XQVU3P	FFRC1517	0	40
XQVU7P	FLRA2104	0	52
XQVU7P	FLRB2104	0	76
XQVU11P	FLRC2104	0	96

Table 1-3: Serial Transceiver Channels (GTH/GTY/GTM) by Device/Package

Device	Package	GTH Channels	GTY Channels	GTM Channels
Virtex UltraScale+ Devices				
XCVU27P	FIGD2104	0	16	30
XCVU29P		0	16	30
XCVU27P	FSGA2577	0	32	48
XCVU29P		0	32	48

User I/O Pins by Device/Package

Table 1-4 lists the number of available 3.3V-capable high-range (HR), 3.3V-capable high-density (HD), and 1.8V-capable high-performance (HP) I/Os and the number of differential I/O pairs for each UltraScale and UltraScale+ device/package combination.



IMPORTANT: Because of package inductance, each device/package supports a limited number of simultaneous switching outputs. Limitations for specific applications can be determined using the Vivado Design Suite report_ssn tool. See the Simultaneous Switching Outputs section of the UltraScale Architecture SelectIO Resources User Guide (UG571) [Ref 5] for more information.

Table 1-4: Available I/O Pins by Device/Package

Device	Package	Total User I/O			Differential I/O		
		HD(1)	HR(1)	HP(1)	HD	HR	HP
Kintex UltraScale Devices							
XCKU035	FBVA676	0	104	208	0	96	192
XCKU040		0	104	208	0	96	192
XCKU035	SFVA784	0	104	364	0	96	336
XCKU040		0	104	364	0	96	336
XCKU035	FBVA900	0	104	364	0	96	336
XCKU040		0	104	364	0	96	336
XCKU025	FFVA1156	0	104	208	0	96	192
XCKU035		0	104	416	0	96	384
XCKU040		0	104	416	0	96	384
XCKU060		0	104	416	0	96	384
XCKU095		0	52	468	0	48	432
XCKU060	FFVA1517	0	104	520	0	96	480
XCKU085	FLVA1517	0	104	520	0	96	480
XCKU115		0	104	520	0	96	480
XCKU095	FFVC1517	0	52	468	0	48	432
XCKU115	FLVD1517	0	104	234	0	96	216
XCKU095	FFVB1760	0	52	598	0	48	552
XCKU085	FLVB1760	0	104	572	0	96	528
XCKU115		0	104	598	0	96	552
XCKU115	FLVA2104	0	156	676	0	144	624
XCKU095	FFVB2104	0	52	650	0	48	600
XCKU115	FLVB2104	0	104	598	0	96	552
XCKU115	FLVD1924	0	156	676	0	144	624

Table 1-4: Available I/O Pins by Device/Package (Cont'd)

Device	Package	Total User I/O			Differential I/O		
		HD(1)	HR(1)	HP(1)	HD	HR	HP
XCKU085	FLVF1924	0	104	520	0	96	480
XCKU115		0	104	624	0	96	576
XQKU040	RBA676	0	104	208	0	96	192
XQKU040	RFA1156	0	104	416	0	96	384
XQKU060		0	104	416	0	96	384
XQKU095		0	52	468	0	48	432
XQKU115	RLD1517	0	104	234	0	96	216
XQKU115	RLF1924	0	104	624	0	96	576
Virtex UltraScale Devices							
XCVU065	FFVC1517	0	52	468	0	48	432
XCVU080		0	52	468	0	48	432
XCVU095		0	52	468	0	48	432
XCVU080	FFVD1517	0	52	286	0	48	264
XCVU095		0	52	286	0	48	264
XCVU125	FLVD1517	0	52	286	0	48	264
XCVU080	FFVB1760	0	52	650	0	48	600
XCVU095		0	52	650	0	48	600
XCVU125	FLVB1760	0	52	650	0	48	600
XCVU080	FFVA2104	0	52	780	0	48	720
XCVU095		0	52	780	0	48	720
XCVU125	FLVA2104	0	52	780	0	48	720
XCVU080	FFVB2104	0	52	650	0	48	600
XCVU095		0	52	650	0	48	600
XCVU125	FLVB2104	0	52	650	0	48	600
XCVU160	FLGB2104	0	52	650	0	48	600
XCVU190		0	52	650	0	48	600
XCVU095	FFVC2104	0	52	364	0	48	336
XCVU125	FLVC2104	0	52	364	0	48	336
XCVU160	FLGC2104	0	52	364	0	48	336
XCVU190		0	52	364	0	48	336
XCVU440	FLGB2377	0	52	1248	0	48	1152
XCVU190	FLGA2577	0	0	448	0	0	412
XCVU440	FLGA2892	0	52	1404	0	48	1296

Table 1-4: Available I/O Pins by Device/Package (Cont'd)

Device	Package	Total User I/O			Differential I/O		
		HD(1)	HR(1)	HP(1)	HD	HR	HP
Kintex UltraScale+ Devices							
XCKU3P	FFVA676	48	0	208	48	0	192
XCKU5P		48	0	208	48	0	192
XCKU3P	FFVB676	72	0	208	72	0	192
XCKU5P		72	0	208	72	0	192
XCKU3P	SFVB784	96	0	208	96	0	192
XCKU5P		96	0	208	96	0	192
XCKU3P	FFVD900	96	0	208	96	0	192
XCKU5P		96	0	208	96	0	192
XCKU11P		96	0	312	96	0	288
XCKU9P	FFVE900	96	0	208	96	0	192
XCKU13P		96	0	208	96	0	192
XCKU11P	FFVA1156	48	0	416	48	0	384
XCKU15P		48	0	468	48	0	432
XCKU11P	FFVE1517	96	0	416	96	0	384
XCKU15P		96	0	416	96	0	384
XCKU15P	FFVA1760	96	0	416	96	0	384
XCKU15P	FFVE1760	96	0	572	96	0	528
XQKU5P	FFRB676	72	0	208	72	0	192
XQKU5P	SFRB784	96	0	208	96	0	192
XQKU15P	FFRA1156	48	0	468	48	0	432
XQKU15P	FFRE1517	96	0	416	96	0	384
Virtex UltraScale+ Devices							
XCVU3P	FFVC1517	0	0	520	0	0	480
XCVU11P	FLGF1924	0	0	624	0	0	576
XCVU31P	FSVH1924	0	0	208	0	0	192
XCVU5P	FLVA2104	0	0	832	0	0	768
XCVU7P		0	0	832	0	0	768
XCVU9P	FLGA2104	0	0	832	0	0	768
XCVU13P	FHGA2104	0	0	832	0	0	768
XCVU5P	FLVB2104	0	0	702	0	0	648
XCVU7P		0	0	702	0	0	648

Table 1-4: Available I/O Pins by Device/Package (Cont'd)

Device	Package	Total User I/O			Differential I/O		
		HD(1)	HR(1)	HP(1)	HD	HR	HP
XCVU9P	FLGB2104	0	0	702	0	0	648
XCVU11P		0	0	572	0	0	528
XCVU13P	FHGB2104	0	0	702	0	0	648
XCVU5P	FLVC2104	0	0	416	0	0	384
XCVU7P		0	0	416	0	0	384
XCVU9P	FLGC2104	0	0	416	0	0	384
XCVU11P		0	0	416	0	0	384
XCVU13P	FHGC2104	0	0	416	0	0	384
XCVU9P	FSGD2104	0	0	676	0	0	624
XCVU11P		0	0	572	0	0	528
XCVU13P	FIGD2104	0	0	676	0	0	624
XCVU27P	FIGD2104	0	0	520	0	0	240
XCVU29P		0	0	676	0	0	312
XCVU33P	FSVH2104	0	0	208	0	0	192
XCVU35P		0	0	416	0	0	384
XCVU9P	FLGA2577	0	0	448	0	0	414
XCVU11P		0	0	448	0	0	414
XCVU13P		0	0	448	0	0	414
XCVU13P	FSGA2577	0	0	448	0	0	414
XCVU27P	FSGA2577	0	0	292	0	0	134
XCVU29P		0	0	448	0	0	206
XCVU35P	FSVH2892	0	0	416	0	0	384
XCVU37P		0	0	624	0	0	576
XQVU3P	FFRC1517	0	0	520	0	0	480
XQVU7P	FLRA2104	0	0	832	0	0	768
XQVU7P	FLRB2104	0	0	702	0	0	648
XQVU11P	FLRC2104	0	0	416	0	0	384

Notes:

1. The maximum user I/O numbers do not include pins in the configuration bank 0 or the GT serial transceivers.

Pin Definitions

Table 1-5 lists the pin definitions used in UltraScale and UltraScale+ device packages.

Table 1-5: Pin Definitions

Pin Name	Type	Direction	Description
User I/O Pins			
IO_L[1 to 24][P or N]_T[0 to 3] [U or L]_N[0 to 12]_ [multi-function]_[bank number] or IO_T[0 to 3][U or L]_N[0 to 12]_[multi-function]_[bank number]			
	Dedicated	Input/Output	<p>Most user I/O pins are capable of differential signaling and can be implemented as pairs. Each user I/O pin name consists of several indicator labels, where:</p> <ul style="list-style-type: none"> • IO indicates a user I/O pin. • L[1 to 24] indicates a unique differential pair with P (positive) and N (negative) sides. User I/O pins without the L indicator are single-ended. • T[0 to 3][U or L] indicates the assigned byte group and nibble location (upper or lower portion) within that group for the pin. • N[0 to 12] the number of the I/O within its byte group. • [multi-function] indicates any other functions that the pin can provide. If not used for this function, the pin can be a user I/O. • [bank number] indicates the assigned bank for the user I/O pin.
User I/O Multi-Function Pins			
GC or HDGC	Multi-function	Input/Output	<p>Four global clock (GC) pin pairs are in each bank. HDGC pins have direct access to the global clock buffers. GC pins have direct access to the global clock buffers, MMCMs, and PLLs that are in the clock management tile (CMT) adjacent to the same I/O bank. GC and HDGC inputs provide dedicated, high-speed access to the internal global and regional clock resources. GC and HDGC inputs use dedicated routing and must be used for clock inputs where the timing of various clocking features is imperative. GC or HDGC pins can be treated as user I/O when not used as input clocks.</p> <p>Up-to-date information about designing with the GC (or HDGC) pin is available in the <i>UltraScale Architecture Clocking Resources User Guide</i> (UG572) [Ref 6].</p>
VRP ⁽¹⁾	Multi-function	N/A	<p>This pin is for the DCI voltage reference resistor of P transistor (per bank, to be pulled Low with a reference resistor).</p>

Table 1-5: Pin Definitions (Cont'd)

Pin Name	Type	Direction	Description
DBC QBC	Multi-function	Input	Byte lane clock (DBC and QBC) input pin pairs are clock inputs directly driving source synchronous clocks to the bit slices in the I/O banks. In memory applications, these are also known as DQS. For more information, consult the <i>UltraScale Architecture SelectIO Resources User Guide</i> (UG571) [Ref 5].
PERSTN[0 to 1]	Multi-function	Input	Default reset pin locations for the integrated block for PCI Express.
User I/O Multi-Function Configuration Pins			
For further descriptions, including configuration modes and recommended external pull-up/pull-down resistors, see the <i>UltraScale Architecture Configuration User Guide</i> (UG570) [Ref 7].			
EMCCLK	Multi-function	Input	External master configuration clock.
DOUT_CSO_B	Multi-function	Output	Data output for serial daisy-chaining or active-Low chip-select output for SelectMAP daisy-chaining.
D[04 to 31]	Multi-function	Bidirectional	Configuration data pins.
A[00 to 28]	Multi-function	Output	Address output.
CSI_ADV_B	Multi-function	Input or Output	Active-Low chip-select input or address valid output.
FOE_B	Multi-function	Output	Active-Low flash output enable.
FWE_FCS2_B	Multi-function	Output	Active-Low flash write-enable for BPI flash or flash chip-select for second SPI (x8) flash.
RS[0 to 1]	Multi-function	Output	Revision select outputs.
Dedicated (Bank 0) Configuration Pins⁽²⁾			
For more information see the <i>UltraScale Architecture Configuration User Guide</i> (UG570) [Ref 7].			
M[0 to 2]_0	Dedicated	Input	Configuration mode selection.
INIT_B_0	Dedicated	Bidirectional (open-drain)	Active-Low initialization

Table 1-5: Pin Definitions (Cont'd)

Pin Name	Type	Direction	Description
CFGBVS_0	Dedicated	Input	Bank 0 and bank 65 voltage select. This pin determines the I/O voltage operating range and voltage tolerance for the dedicated configuration bank 0 and multi-function bank 65. Connect CFGBVS High or Low per the bank voltage requirements. <ul style="list-style-type: none"> • V_{CCO_0} = 2.5V or 3.3V, tie CFGBVS High (connect to V_{CCO_0}). • V_{CCO_0} = 1.5V or 1.8V, tie CFGBVS Low (connect to GND) <hr/> CAUTION! To avoid device damage, this pin must be connected correctly to either V_{CCO_0} or GND.
PUDC_B_0	Dedicated	Input	Active-Low input enables internal pull-ups during configuration on all SelectIO pins: 0 = Weak preconfiguration I/O pull-up resistors enabled. 1 = Weak preconfiguration I/O pull-up resistors disabled.
POR_OVERRIDE	Dedicated	Input	All configuration modes Power-on reset delay override. <hr/> CAUTION! Do not allow this pin to float before and during configuration. This pin must be tied to V_{CCINT} or GND. Do not connect to V_{CCO_0} . <hr/> Information about designing with the POR_OVERRIDE pin is available in the <i>UltraScale Architecture Configuration User Guide</i> (UG570) [Ref 7].
DONE_0	Dedicated	Bidirectional	Active-High, DONE indicates successful completion of configuration.
PROGRAM_B_0	Dedicated	Input	Active Low, asynchronous reset to configuration logic.
TDO_0	Dedicated	Output	JTAG test data output.
TDI_0	Dedicated	Input	JTAG test data input.
RDWR_FCS_B_0	Dedicated	Input/Output	Input control signal for SelectMAP data bus direction: High for reading or Low for writing configuration data. Or, active-Low flash chip-select output.
TMS_0	Dedicated	Input	JTAG test mode data select.
TCK_0	Dedicated	Input	JTAG test clock
CCLK_0	Dedicated	Input/Output	Configuration clock. Output in Master mode or input in Slave mode.
D00_MOSI_0	Dedicated	Bidirectional	Data Bit 0 or SPI master-output
D01_DIN_0	Dedicated	Bidirectional	Data Bit 1 or serial mode data input
D02_0	Dedicated	Bidirectional	Data Bit 2
D03_0	Dedicated	Bidirectional	Data Bit 3

Table 1-5: Pin Definitions (Cont'd)



Pin Name	Type	Direction	Description
Other Dedicated Pins			
DXN	Dedicated	N/A	Temperature-sensing diode pins (Anode: DXP; Cathode: DXN). The thermal diode is accessed by using the DXP and DXN pins in bank 0. When not used, tie to GND.
DXP			To use the thermal diode an appropriate external thermal monitoring IC must be added. Consult the external thermal monitoring IC data sheet for usage guidelines.
System Monitor Pins⁽³⁾			
AD[0 to 15][P or N]	Multi-function	Input	System Monitor differential auxiliary analog inputs 0–15.
VCCADC	Dedicated	N/A	System Monitor analog positive supply voltage.
GNDADC	Dedicated	N/A	System Monitor analog ground reference.
VREFP	Dedicated	N/A	Voltage reference input.
VREFN	Dedicated	N/A	Voltage reference GND.
VP	Dedicated	Input	System Monitor dedicated differential analog input (positive side).
VN	Dedicated	Input	System Monitor dedicated differential analog input (negative side).
I2C_SCLK	Multi-function	Bidirectional	I2C serial clock. Directly connected to the System Monitor DRP interface for I2C operation configuration.  <hr/> IMPORTANT: Because the SYSMON I2C interface is active after power-on, this pin should only be used for I2C access until after configuration.
I2C_SDA	Multi-function	Bidirectional	I2C serial data line. Directly connected to the System Monitor DRP interface for I2C operation configuration.  <hr/> IMPORTANT: Because the SYSMON I2C interface is active after power-on, this pin should only be used for I2C access until after configuration.

Table 1-5: Pin Definitions (Cont'd)

Pin Name	Type	Direction	Description
SMBALERT	Multi-function	Bidirectional	<p>Optional PMBus alert, interrupt signal. When Low, indicates a system fault that must be cleared using PMBus commands. Connect to SMBALERT_TS.</p> <p>For more information, see the <i>UltraScale Architecture System Monitor User Guide</i> (UG580) [Ref 10].</p> <p></p> <hr/> <p>IMPORTANT: <i>By default, the PMBus is active prior to configuration. Only use as a multi-functional I/O pin in designs that can tolerate this pin being driven prior to configuration.</i></p> <hr/> <p>This pin is present on Kintex UltraScale+ and Virtex UltraScale+ devices.</p>
Power/Ground Pins			
For more information on voltage specifications see the <i>UltraScale and UltraScale+ device data sheets</i> [Ref 3] .			
GND	Dedicated	N/A	Ground.
VCCINT	Dedicated	N/A	Power-supply pins for the internal logic.
VCCINT_IO	Dedicated	N/A	Power-supply pins for the I/O banks. For Kintex and Virtex UltraScale devices, connect VCCINT_IO to VCCINT. For Kintex and Virtex UltraScale+ devices, connect VCCINT_IO to VCCBRAM. Both migration and lower voltage differences (-1LI and -2LE at 0.72V) are discussed in the <i>UltraScale Architecture PCB and Pin Planning User Guide</i> (UG583). See the connection matrix in the <i>Power Supply Voltage Levels and VCCINT_IO Connection</i> section [Ref 11] .
VCCINT_GT_[L or R]	Dedicated	N/A	GTM core power-supply pins.
VCCAUX	Dedicated	N/A	Power-supply pins for auxiliary circuits.
VCCAUX_IO	Dedicated	N/A	<p>Auxiliary power-supply pins for the I/O banks. VCCAUX_IO must be connected to VCCAUX on the board.</p> <p>Note: Package files for XQ ruggedized Kintex and Virtex UltraScale+ devices (for example: FFRB676) have unique pin names for VCCAUX_HPIO and VCCAUX_HDIO. These pins can be connected to a common VCCAUX_IO supply.</p>
VCCIO_HBM_[HBM bank number]	Dedicated	N/A	HBM component I/O power supply (VDDQ)
VCC_HBM_[HBM bank number]	Dedicated	N/A	HBM component core power supply (VDDC)
VCCAUX_HBM_[HBM bank number]	Dedicated	N/A	HBM component word line voltage pump (VPP)
VCCBRAM	Dedicated	N/A	Block RAM power supply pins.

Table 1-5: Pin Definitions (Cont'd)

Pin Name	Type	Direction	Description
VBATT	Dedicated	N/A	Decryptor key memory backup supply; this pin should be tied to the appropriate V_{CC} or GND when not used.
VCCO_[bank number] ⁽⁴⁾	Dedicated	N/A	Power-supply pins for the output drivers (per bank).
VREF_[bank number]	Dedicated	N/A	These are input threshold voltage pins.
RSVDGND	Dedicated	N/A	Reserved pins—must be tied to GND. These pins are present on Kintex UltraScale+ and Virtex UltraScale+ devices.  TIP: In footprint compatible devices, this pin can be labeled differently and serve different purposes. When planning migration between devices, include the functionality between all footprint compatible devices.
RSVD	Dedicated	N/A	Reserved pins—leave floating.  TIP: In footprint compatible devices, this pin can be labeled differently and serve different purposes. When planning migration between devices, include the functionality between all footprint compatible devices.
Multi-gigabit Serial Transceiver Pins (GTHE3 and GTYE3)			
For more information on the GTH and GTY transceivers see the <i>UltraScale Architecture GTH Transceivers User Guide</i> (UG576) [Ref 8] or <i>UltraScale Architecture GTY Transceivers User Guide</i> [Ref 9] .			
MGTHRXP[P or N][0 to 3]_[GT quad number]	Dedicated	Input	Differential receive port GTH Quad.
MGTHTXP[P or N][0 to 3]_[GT quad number]	Dedicated	Output	Differential transmit port GTH Quad.
MGTYRX[P or N][0 to 3]_[GT quad number]	Dedicated	Input	Differential receive port GTY Quad.
MGTYTX[P or N][0 to 3]_[GT quad number]	Dedicated	Output	Differential transmit port GTY Quad.
MGTYRX[P or N][0 to 3]_[GT dual number]	Dedicated	Input	Differential receive port GTM Dual.
MGTYTX[P or N][0 to 3]_[GT dual number]	Dedicated	Output	Differential transmit port GTM Dual.
MGTAVCC_[L or R][N, UC, C, LC, or S] ⁽⁵⁾	Dedicated	Input	Analog power-supply pin for the receiver and transmitter internal circuits.

Table 1-5: Pin Definitions (Cont'd)

Pin Name	Type	Direction	Description
MGTAVTT_[L or R] [N, UC, C, LC, or S] ⁽⁵⁾	Dedicated	Input	Analog power-supply pin for the transmit driver.
MGTVCCAUX_[L or R] [N, UC, C, LC, or S] ⁽⁵⁾	Dedicated	Input	Auxiliary analog Quad PLL (QPLL) voltage supply for the transceivers.
MGTREFCLK[0 or 1] [P or N]	Dedicated	Input	Differential reference clock for the transceivers.
MGTAVTTRCAL_[L or R] [N, UC, C, LC, or S] ⁽⁵⁾	Dedicated	N/A	Precision reference resistor pin for internal calibration termination.
MGTRREF_[L or R] [N, UC, C, LC, or S] ⁽⁵⁾	Dedicated	Input	Precision reference resistor pin for internal calibration termination.

Notes:

1. See the DCI sections in *UltraScale Architecture SelectIO Resources User Guide* (UG571) [Ref 5] for more information on the VRP pins.
2. All dedicated configuration pins are powered by V_{CC0_0} .
3. See the *UltraScale Architecture System Monitor User Guide* (UG580) [Ref 10] for the default connections required to support on-chip monitoring.
4. V_{CC0} pins in unbonded banks must be connected to the V_{CC0} for that bank (for package migration). Do NOT connect unbonded V_{CC0} pins to different supplies. Without a package migration requirement, V_{CC0} pins in unbonded banks can be tied to a common supply (V_{CC0} or GND).
5. L (left) or R (right) plus N (north), UC (upper center), C (center), LC (lower center), and S (south) signify the GT transceiver quad power supply groups. For example, RUC signifies the right-upper-center power supply group and LLC signifies the left-lower-center power supply group in the FLGA2577 package.

Footprint Compatibility between Packages

UltraScale and UltraScale+ devices are footprint compatible only with other UltraScale and UltraScale+ devices with the same number of package pins and the same preceding alphabetic designator. For example, XCKU060-FFVA1517 is compatible with XCKU085-FLVA1517 and XCKU115-FLVA1517, but not with XCKU115-FLVD1517. Pins that are available in one device but are not available in another device with a compatible package include the other device's name in the *No Connect* column of the package file. These pins are labeled as *No Connects* in the other device's package file.

 **IMPORTANT:** Footprint compatibility does not necessarily imply that all pins will function in the same manner for different devices in a package. For limitations and guidelines on designing for footprint compatible packages, refer to the *Migration Between UltraScale Devices and Packages* section of *UltraScale Architecture PCB and Pin Planning User Guide (UG583)* [Ref 11].

Table 1-6 shows the footprint compatible devices available for each UltraScale and UltraScale+ device package. See *UltraScale Architecture and Product Overview (DS890)* [Ref 1] for specific package letter code options.

 **IMPORTANT:** The height dimensions of footprint compatible packages can vary since some devices contain SSI technology.

Table 1-6: Footprint Compatibility

Packages	Footprint Compatible Devices										
A676	XCKU035	XCKU040	XQKU040	XCKU3P	XCKU5P						
B676	XCKU3P	XCKU5P	XQKU5P								
A784	XCKU035	XCKU040									
B784	XCKU3P	XCKU5P	XQKU5P								
A900	XCKU035	XCKU040									
D900	XCKU3P	XCKU5P	XCKU11P								
E900	XCKU9P	XCKU13P									
A1156	XCKU025	XCKU035	XCKU040	XQKU040	XCKU060	XQKU060	XCKU095	XQKU095	XCKU11P	XCKU15P	XQKU15P

Table 1-6: Footprint Compatibility (Cont'd)

Packages	Footprint Compatible Devices													
A1517	XCKU060	XCKU085	XCKU115											
C1517	XCKU095	XCVU065	XCVU080	XCVU095	XCVU3P	XQVU3P								
D1517	XCKU115	XQKU115	XCVU080	XCVU095	XCVU125									
E1517	XCKU11P	XCKU15P	XQKU15P											
A1760	XCKU15P													
B1760	XCKU085	XCKU095	XCKU115	XCVU080	XCVU095	XCVU125								
E1760	XCKU15P													
D1924	XCKU115													
F1924	XCKU085	XCKU115	XQKU115	XCVU11P										
H1924	XCVU31P													
A2104	XCKU115	XCVU080	XCVU095	XCVU125	XCVU5P	XCVU7P	XCVU9P	XCVU13P ⁽¹⁾	XQVU7P					
B2104	XCKU095	XCKU115	XCVU080	XCVU095	XCVU125	XCVU160	XCVU190	XCVU5P	XCVU7P	XCVU9P	XCVU11P	XCVU13P ⁽¹⁾	XQVU7P	
C2104	XCVU095	XCVU125	XCVU160	XCVU190	XCVU5P	XCVU7P	XCVU9P	XCVU11P	XCVU13P ⁽¹⁾	XQVU11P				
D2104	XCVU9P	XCVU11P	XCVU13P	XCVU27P ⁽¹⁾	XCVU29P ⁽¹⁾									
H2104	XCVU33P	XCVU35P												
B2377	XCVU440													
A2577	XCVU190	XCVU9P	XCVU11P	XCVU13P	XCVU27P	XCVU29P								
A2892	XCVU440													
H2892	XCVU35P	XCVU37P												

Notes:

1. While footprint compatible, the body size for the VU13P, VU27P, and VU39P is 52.5 mm, which is larger than the 47.5 mm for a 2104 ball package.

Many UltraScale and UltraScale+ devices that are footprint compatible in a package have different I/O bank and transceiver quad numbers connected to the same package pins. Due to these differences, when migrating between devices in a specific package, the type of bank (HP vs. HR) or quad (GTH vs. GTY), whether a bank is connected or NC at the package pins, and where the bank or quad is located on the die must be taken into consideration. [Table 1-7](#) and [Table 1-8](#) show how the banks and transceiver quads are numbered between devices in each package.

For all grouped-together footprint compatible packages, the bank and quad numbers in the same column for each device are connect to the same package pins. For example, in the FFVD1517 and FLVD1517 packages, bank 69 for the XCVU095 is connected to the same pins as bank 71 for the XCVU125.

A limited number of banks have fewer than 52 SelectIO pins. For a visual representation of all of this information, see the [Die Level Bank Numbering Overview](#) section.

Table 1-7: I/O Bank Migration: HP I/O Banks are Unshaded, HR I/O Banks are in Gray, and HD I/O Banks are in Dark Gray)⁽¹⁾

Package	Device	Package to Device I/O Mapping																								Unbonded I/O Banks							
		A	B	C	D	E	F	G	H	I	J	K	L	M	N	O	P	Q	R	S	T	U	V	W	X		Y	Z	AA	AB	AC		
FBVA676	XCKU035			65	66	44	45	46											64														47, 48, 67, 68
	XCKU040			65	66	44	45	46											64														47, 48, 67, 68
RBA676	XQKU040			65	66	44	45	46										64														47, 48, 67, 68	
FFVA676	XCKU3P			65	66	64		67										84/85														86, 87	
	XCKU5P			65	66	64		67										84/85														86, 87	
FFVB676	XCKU3P	84	64	65	66	67	86	87																								85	
	XCKU5P	84	64	65	66	67	86	87																								85	
FFRB676	XQKU5P	84	64	65	66	67	86	87																								85	
SFVA784	XCKU035			65	44	45	46	47	66	68	67							64														48	
	XCKU040			65	44	45	46	47	66	68	67							64														48	
SFVB784	XCKU3P		64	65	66	67	87	86	84	85																							
	XCKU5P		64	65	66	67	87	86	84	85																							
SFRB784	XQKU5P		64	65	66	67	87	86	84	85																							
FBVA900	XCKU035			65	66	67	44	45	46	47	48							64														68	
	XCKU040			65	66	67	44	45	46	47	48							64														68	
FFVD900	XCKU3P			65	66	64	67					84	85	87	86																		
	XCKU5P			65	66	64	67					84	85	87	86																		
	XCKU11P			65	66	67	68	69	70			88	89	91	90																	71, 64	
FFVE900	XCKU9P		64	65	66	67	44	47										48	49													50	
	XCKU13P		64	65	66	67	44	47										48	49													50	

Table 1-7: I/O Bank Migration: HP I/O Banks are Unshaded, HR I/O Banks are in Gray, and HD I/O Banks are in Dark Gray⁽¹⁾ (Cont'd)

Package	Device	Package to Device I/O Mapping																								Unbonded I/O Banks											
		A	B	C	D	E	F	G	H	I	J	K	L	M	N	O	P	Q	R	S	T	U	V	W	X		Y	Z	AA	AB	AC						
FFVA1156	XCKU025			65	66				44	45	46								64																		
	XCKU035			65	66	67	68	44	45	46	47	48							64																		
	XCKU040			65	66	67	68	44	45	46	47	48							64																		
	XCKU060			65	66	67	68	44	45	46	47	48							64															24, 25			
	XCKU095			65	66	68	67	45	44	46	47	48							64																49, 50, 51, 69, 70, 71		
	XCKU11P			65	66	70	71	67	64		68	69							88/89																90, 91		
	XCKU15P			65	66	71	72	67	64	68	69	70							90/91																	73, 74, 93, 94	
FFRA1156	XQKU15P			65	66	71	72	67	64	68	69	70						90/91																	73, 74, 93, 94		
RFA1156	XQKU040			65	66	67	68	44	45	46	47	48						64																			
	XQKU060			65	66	67	68	44	45	46	47	48						64																		24, 25	
	XQKU095			65	66	68	67	45	44	46	47	48						64																		49, 50, 51, 69, 70, 71	
FFVA1517	XCKU060			65	44	45	24	25	66	67	68	46	47	48				64																			
FLVA1517	XCKU085			65	44	45	24	25	66	67	68	46	47	48				64																	29, 30, 49, 50, 51, 52, 69, 70, 71, 72		
	XCKU115			65	44	45	24	25	66	67	68	46	47	48				64																		29, 30, 49, 50, 51, 52, 69, 70, 71, 72	
FFVC1517	XCKU095		84/94	65	66	67	68	44	45	46	47	48																								51, 50, 49, 71, 70, 69	
	XCVU080		84/94	65	66	67	68	44	45	46	47	48																									51, 50, 49, 71, 70, 69
	XCVU065		84/94	65	66	67	68	44	45	46	47	48																									
	XCVU095		84/94	65	66	67	68	44	45	46	47	48																									51, 50, 49, 71, 70, 69
	XCVU3P		64	65	66	67	68	44	45	46	47	48																									
FFRC1517	XQVU3P		64	65	66	67	68	44	45	46	47	48																									

Table 1-7: I/O Bank Migration: HP I/O Banks are Unshaded, HR I/O Banks are in Gray, and HD I/O Banks are in Dark Gray⁽¹⁾ (Cont'd)

Package	Device	Package to Device I/O Mapping																				Unbonded I/O Banks															
		A	B	C	D	E	F	G	H	I	J	K	L	M	N	O	P	Q	R	S	T		U	V	W	X	Y	Z	AA	AB	AC						
FFVD1517	XCVU080	84/94	65	66	67 ⁽²⁾	69	70	71																			44, 45, 46, 47, 48, 49, 50, 51, 68										
	XCVU095	84/94	65	66	67 ⁽²⁾	69	70	71																			44, 45, 46, 47, 48, 49, 50, 51, 68										
FLVD1517	XCKU115	84/94	65	66	67 ⁽²⁾	71	72	73																			24, 25, 29, 30, 44, 45, 46, 47, 48, 49, 50, 51, 52, 53, 68, 69, 70										
	XCVU125	84/94	65	66	67 ⁽²⁾	71	72	73																			44, 45, 46, 47, 48, 49, 50, 51, 52, 53, 68, 69, 70										
RLD1517	XQKU115	84/94	65	66	67 ⁽²⁾	71	72	73																			24, 25, 29, 30, 44, 45, 46, 47, 48, 49, 50, 51, 52, 53, 68, 69, 70										
FFVE1517	XCKU11P		65	64	66	67	68											91	90	89	88	71	70	69													
	XCKU15P		65	64	66	67	68											94	93	91	90	71	70	69													
FFRE1517	XQKU15P		65	64	66	67	68											94	93	91	90	71	70	69													
FFVA1760	XCKU15P		65	64	66	67	68											94	93	91	90	72	71	70													
FLVB1760	XCKU085	84/94	65	66	67	44	45	46	47	48	49	50	51	52														24, 25, 29, 30, 68, 69, 70, 71, 72									
	XCKU115	84/94	65	66	67	44	45	46	47	48	49	50	51	52	53 ⁽²⁾														24, 25, 29, 30, 68, 69, 70, 71, 72, 73								
FFVB1760	XCKU095	84/94	65	66	67	44	45	46	47	48	70	71	49	50	51 ⁽²⁾														68, 69								
	XCVU080	84/94	65	66	67	44	45	46	47	48	70	71	49	50	51 ⁽²⁾														68, 69								
	XCVU095	84/94	65	66	67	44	45	46	47	48	70	71	49	50	51 ⁽²⁾														68, 69								
FLVB1760	XCVU125	84/94	65	66	67	44	45	46	47	48	49	50	51	52	53 ⁽²⁾														68, 69, 70, 71, 72, 73								
FFVE1760	XCKU15P		65	64	66	67	68	69											94	93	91	90	74	73	72	71	70										

Table 1-7: I/O Bank Migration: HP I/O Banks are Unshaded, HR I/O Banks are in Gray, and HD I/O Banks are in Dark Gray⁽¹⁾ (Cont'd)

Package	Device	Package to Device I/O Mapping																								Unbonded I/O Banks					
		A	B	C	D	E	F	G	H	I	J	K	L	M	N	O	P	Q	R	S	T	U	V	W	X		Y	Z	AA	AB	AC
FLVD1924	XCKU115		84/94	65	66	67	44	45	46	47	50	51	52	53	70	71	72	73											24, 25, 29, 30, 48, 49, 68, 69		
FLVF1924	XCKU085				65	66	67	68	44	45	46	51	52			70	71	72											30, 29, 25, 24, 50, 49, 48, 47, 69, 64		
	XCKU115				65	66	67	68	44	45	46	51	52	53			70	71	72	73											30, 29, 25, 24, 50, 49, 48, 47, 69, 64
RLF1924	XQKU115				65	66	67	68	44	45	46	51	52	53			70	71	72	73											30, 29, 25, 24, 50, 49, 48, 47, 69, 64
FLGF1924	XCVU11P				65	66	67	68	64				69	70	71	72	73	74	75												
FSVH1924	XCVU31P		64	65	66	67																									
FFVA2104	XCVU080		84/94	65	66	67	44	45	46	47	48	49	50	51	68	69	70	71													
	XCVU095		84/94	65	66	67	44	45	46	47	48	49	50	51	68	69	70	71													
FLVA2104	XCKU115		84/94	65	66	67	44	45	46	47	50	51	52	53	70	71	72	73											30, 29, 25, 24, 49, 48, 69, 68		
	XCVU125		84/94	65	66	67	44	45	46	47	50	51	52	53	70	71	72	73											49, 48, 69, 68		
	XCVU5P		64	65	66	67	44	45	46	47	50	51	52	53	70	71	72	73											49, 48, 69, 68		
	XCVU7P		64	65	66	67	44	45	46	47	50	51	52	53	70	71	72	73											49, 48, 69, 68		
FLRA2104	XQVU7P		64	65	66	67	44	45	46	47	50	51	52	53	70	71	72	73											49, 48, 69, 68		
FLGA2104	XCVU9P		64	65	66	67	40	41	42	43	45	46	47	48	70	71	72	73											53, 52, 51, 50, 49, 44, 39, 69, 68, 63, 62, 61, 60, 59		
FHGA2104	XCVU13P		64	65	66	67	60	61	62	63	68	69	70	71	72	73	74	75													

Table 1-7: I/O Bank Migration: HP I/O Banks are Unshaded, HR I/O Banks are in Gray, and HD I/O Banks are in Dark Gray)⁽¹⁾ (Cont'd)

Package	Device	Package to Device I/O Mapping																								Unbonded I/O Banks		
		A	B	C	D	E	F	G	H	I	J	K	L	M	N	O	P	Q	R	S	T	U	V	W	X		Y	Z
FFVB2104	XCKU095	84/94	65	66	67	68 ⁽²⁾	44	45	46	49	50	51	69	70	71													48, 47
	XCVU080	84/94	65	66	67	68 ⁽²⁾	44	45	46	49	50	51	69	70	71													48, 47
	XCVU095	84/94	65	66	67	68 ⁽²⁾	44	45	46	49	50	51	69	70	71													48, 47
FLVB2104	XCKU115	84/94	65	66	67	68 ⁽²⁾	44	45	46	51	52	53	71	72	73													30, 29, 25, 24, 50, 49, 48, 47, 70, 69
	XCVU125	84/94	65	66	67	68 ⁽²⁾	44	45	46	50	51	52	70	71	72													53, 49, 48, 47, 73, 69
	XCVU5P	64	65	66	67	68 ⁽²⁾	44	45	46	50	51	52	70	71	72													53, 49, 48, 47, 73, 69
	XCVU7P	64	65	66	67	68 ⁽²⁾	44	45	46	50	51	52	70	71	72													53, 49, 48, 47, 73, 69
FLRB2104	XQVU7P	64	65	66	67	68 ⁽²⁾	44	45	46	50	51	52	70	71	72													53, 49, 48, 47, 73, 69
FLGB2104	XCVU160	84/94	65	66	67	68 ⁽²⁾	44	45	46	50	51	52	70	71	72													53, 49, 48, 47, 43, 42, 41, 40, 73, 69, 63, 62, 61, 60
	XCVU190	84/94	65	66	67	68 ⁽²⁾	44	45	46	50	51	52	70	71	72													53, 49, 48, 47, 43, 42, 41, 40, 39, 73, 69, 63, 62, 61, 60, 59
	XCVU9P	64	65	66	67	68 ⁽²⁾	40	41	42	46	47	48	70	71	72													53, 52, 51, 50, 49, 45, 44, 43, 39, 73, 69, 63, 62, 61, 60, 59
	XCVU11P	64	65	66	67		68			69	70	71	72	73	74													75
FHGB2104	XCVU13P	64	65	66	67	68 ⁽²⁾	61	62	63	69	70	71	72	73	74													75, 60

Table 1-7: I/O Bank Migration: HP I/O Banks are Unshaded, HR I/O Banks are in Gray, and HD I/O Banks are in Dark Gray)⁽¹⁾ (Cont'd)

Package	Device	Package to Device I/O Mapping																								Unbonded I/O Banks		
		A	B	C	D	E	F	G	H	I	J	K	L	M	N	O	P	Q	R	S	T	U	V	W	X		Y	Z
FFVC2104	XCVU095	84/94	65	66	67	68	69	70	71																	51, 50, 49, 48, 47, 46, 45, 44		
FLVC2104	XCVU125	84/94	65	66	67	68	70	71	72																	53, 52, 51, 50, 49, 48, 47, 46, 45, 44, 73, 69		
	XCVU5P	64	65	66	67	68	70	71	72																	53, 52, 51, 50, 49, 48, 47, 46, 45, 44, 73, 69		
	XCVU7P	64	65	66	67	68	70	71	72																	53, 52, 51, 50, 49, 48, 47, 46, 45, 44, 73, 69		
	XCVU160	84/94	65	66	67	68	70	71	72																	52, 51, 50, 49, 48, 47, 46, 45, 44, 43, 42, 41, 40, 69, 63, 62, 61, 60		
FLGC2104	XCVU190	84/94	65	66	67	68	70	71	72																	53, 52, 51, 50, 49, 48, 47, 46, 45, 44, 43, 42, 41, 40, 39, 73, 69, 63, 62, 61, 60, 59		
	XCVU9P	64	65	66	67	68	70	71	72																	53, 52, 51, 50, 49, 48, 47, 46, 45, 44, 43, 42, 41, 40, 39, 73, 69, 63, 62, 61, 60, 59		
	XCVU11P	64	65	66	67	68	69	70	71																	75, 74, 73, 72		
	XQVU11P	64	65	66	67	68	69	70	71																	75, 74, 73, 72		
FHGC2104	XCVU13P	64	65	66	67	68	69	70	71																	75, 74, 73, 72, 63, 62, 61, 60		
FSGD2104	XCVU9P	64	65	66	67	40	41	42	46	47	48	70	71	72													53, 52, 51, 50, 49, 45, 44, 43, 39, 73, 69, 68, 63, 62, 61, 60, 59	
	XCVU11P	64	65	66	67	68	69	70	71	72	73	74													75			
FIGD2104	XCVU13P	64	65	66	67	61	62	63	69	70	71	72	73	74													75, 68, 60	
	XCVU27P	64	65	66	67	61	62	63	69	70	71	72	73	74													75, 68, 60	
	XCVU29P	64	65	66	67	61	62	63	69	70	71	72	73	74													75, 68, 60	
	XCVU33P	64	65	66	67																							
XCVU35P	64	65	66	67	68	69	70	71																				
FLGB2377	XCVU440	84/94	65	66	67	68	60	61	62	63	40	41	42	43	45	46	47	48	50	51	52	53	70	71	72	73	39, 44, 49, 59, 69	

Table 1-7: I/O Bank Migration: HP I/O Banks are Unshaded, HR I/O Banks are in Gray, and HD I/O Banks are in Dark Gray⁽¹⁾ (Cont'd)

Package	Device	Package to Device I/O Mapping																										Unbonded I/O Banks			
		A	B	C	D	E	F	G	H	I	J	K	L	M	N	O	P	Q	R	S	T	U	V	W	X	Y	Z		AA	AB	AC
FLGA2577	XCVU190		66 ⁽²⁾	65	61	62	63	67	68 ⁽²⁾	70	71	72															53, 52, 51, 50, 49, 48, 47, 46, 45, 44, 43, 42, 41, 40, 39, 73, 69, 64, 60, 59				
	XCVU9P		66 ⁽²⁾	65	61	62	63	67	68 ⁽²⁾	70	71	72															53, 52, 51, 50, 49, 48, 47, 46, 45, 44, 43, 42, 41, 40, 39, 73, 69, 64, 60, 59				
	XCVU11P		66 ⁽²⁾	65	68	69	70	71	72 ⁽²⁾	73	74	75															67, 64				
	XCVU13P		66 ⁽²⁾	65	61	62	63	70	71 ⁽²⁾	73	74	75															72, 69, 68, 67, 64, 60				
FSGA2577	XCVU13P		66 ⁽²⁾	65	61	62	63	70	71 ⁽²⁾	73	74	75															72, 69, 68, 67, 64, 60				
	XCVU27P		66 ⁽²⁾	65	61	62	63	70	71 ⁽²⁾	73	74	75															72, 69, 68, 67, 64, 60				
	XCVU29P		66 ⁽²⁾	65	61	62	63	70	71 ⁽²⁾	73	74	75															72, 69, 68, 67, 64, 60				
FLGA2892	XCVU440		84/94	65	66	67	68	60	61	62	63	39	40	41	42	43	44	45	46	47	48	49	50	51	52	53	70	71	72	73	59, 69
FSVH2892	XCVU35P		64	65	66	67	68	69		70	71																				
	XCVU37P		64	65	66	67	68	69		70	71	72	73	74	75																

Notes:

1. See the [Die Level Bank Numbering Overview](#) for specific changes in column numbering.
2. A limited number of banks have fewer than 52 SelectIO pins. These banks are labeled as partial.

For each grouped set of footprint compatible packages listed in [Table 1-8](#), there is a row detailing the power supply group for each quad. These groups are labeled according to the regions for the transceiver power supply pins, as listed in the [ASCII Pinout Files](#) linked from [Chapter 2, Package Files](#). For a visual representation of all of this information, see the [Die Level Bank Numbering Overview](#) section.

Table 1-8: Transceiver Quad Migration (GTH Quads are White, GTY Quads are Gray, GTM Duals are Dark Gray)

Package	Device	Package to Device Transceiver Mapping																								Unbonded GT Quads					
		A	B	C	D	E	F	G	H	I	J	K	L	M	N	O	P	Q	R	S	T	U	V	W	X		Y	Z	AA	AB	AC
Power Supply Group		—																													
FBVA676	XCKU035	224	225	226	227																									228	
	XCKU040	224	225	226	227																									228	
RBA676	XQKU040	224	225	226	227																									228	
Power Supply Group		R																													
FFVA676	XCKU3P	224	225	226	227																										
	XCKU5P	224	225	226	227																										
Power Supply Group		R																													
FFVB676	XCKU3P	224	225	226	227																										
	XCKU5P	224	225	226	227																										
FFRA676	XQKU5P	224	225	226	227																										
Power Supply Group		—																													
SFVA784	XCKU035	224	225																											228,227,226	
	XCKU040	224	225																											228,227,226	
Power Supply Group		R																													
SFVB784	XCKU3P	224	225	226	227																										
	XCKU5P	224	225	226	227																										
SFRB784	XQKU5P	224	225	226	227																										

Table 1-8: Transceiver Quad Migration (GTH Quads are White, GTY Quads are Gray, GTM Duals are Dark Gray) (Cont'd)

Package	Device	Package to Device Transceiver Mapping																								Unbonded GT Quads								
		A	B	C	D	E	F	G	H	I	J	K	L	M	N	O	P	Q	R	S	T	U	V	W	X		Y	Z	AA	AB	AC	AD	AE	AF
Power Supply Group		—																																
FBVA900	XCKU035	224	225	226	227																													
	XCKU040	224	225	226	227																													
Power Supply Group		R																																
FFVD900	XCKU3P	224	225	226	227																													
	XCKU5P	224	225	226	227																													
	XCKU11P	224	225	226	227																													
Power Supply Group		R				L																												
FFVE900	XCKU9P	228	229	230	127	128	129	130																										
	XCKU13P	228	229	230	127	128	129	130																										

Table 1-8: Transceiver Quad Migration (GTH Quads are White, GTY Quads are Gray, GTM Duals are Dark Gray) (Cont'd)

Package	Device	Package to Device Transceiver Mapping																										Unbonded GT Quads							
		A	B	C	D	E	F	G	H	I	J	K	L	M	N	O	P	Q	R	S	T	U	V	W	X	Y	Z		AA	AB	AC	AD	AE	AF	
Power Supply Group		R					L																												
FFVA1156	XCKU025	224	225	226																															
	XCKU035	224	225	226	227																						228								
	XCKU040	224	225	226	227	228																													
	XCKU060	224	225	226	227	228	127	128																			126								
	XCKU095	224	225	226	227	228	129	130																			131, 128, 127, 126, 125, 124, 231, 230, 229								
	XCKU11P	224	225	226	227	228	129	130																			131, 128, 127, 231, 230								
	XCKU15P	224	225	226	227	228	129	130																			134, 133, 132, 131, 128, 127, 234, 233, 232, 231, 230, 229								
FFRA1156	XQKU15P	224	225	226	227	228	129	130																			134, 133, 132, 131, 128, 127, 234, 233, 232, 231, 230, 229								
RFA1156	XQKU040	224	225	226	227	228																													
	XQKU060	224	225	226	227	228	127	128																			126								
	XQKU095	224	225	226	227	228	129	130																			131, 128, 127, 126, 125, 124, 231, 230, 229								

Table 1-8: Transceiver Quad Migration (GTH Quads are White, GTY Quads are Gray, GTM Duals are Dark Gray) (Cont'd)

Package	Device	Package to Device Transceiver Mapping																								Unbonded GT Quads										
		A	B	C	D	E	F	G	H	I	J	K	L	M	N	O	P	Q	R	S	T	U	V	W	X		Y	Z	AA	AB	AC	AD	AE	AF		
Power Supply Group		RS					RN					L																								
FFVA1517	XCKU060	224	225	226	227	228						126	127	128																						
FLVA1517	XCKU085	224	225	226	227	228	229	230	231	232	126	127	128															132,131								
	XCKU115	224	225	226	227	228	229	230	231	232	126	127	128															132,131								
Power Supply Group		R					L																													
FFVC1517	XCKU095	224	225	226	227	228	125	126	127	128	129															131, 130, 124, 231, 230, 229										
	XCVU080	224	225	226	227	228	125	126	127	128	129															131, 130, 124, 231, 230, 229										
	XCVU065	224	225	226	227	228	124	125	126	127	128																									
	XCVU095	224	225	226	227	228	125	126	127	128	129															131, 130, 124, 231, 230, 229										
	XCVU3P	224	225	226	227	228	124	125	126	127	128																									
FFRC1517	XQVU3P	224	225	226	227	228	124	125	126	127	128																									
Power Supply Group		RS					RN					LS				LN																				
FFVD1517	XCVU080	224	225	226	227	228	229	230	231			124	125	126	127	128	129	130	131																	
	XCVU095	224	225	226	227	228	229	230	231			124	125	126	127	128	129	130	131																	
FLVD1517	XCVU125	224	225	226	227	228	229	230	231	232	233	124	125	126	127	129	130	131	132															133,128		
	XCKU115	224	225	226	227	228	229	230	231	232	233			126	127	128			131	132	133															
RLD1517	XQKU115	224	225	226	227	228	229	230	231	232	233			126	127	128			131	132	133															
Power Supply Group		RS					RN					L																								
FFVE1517	XCKU11P	224	225	226	227	228	229	230	231	127	128	129	130	131																						
	XCKU15P	224	225	226	227	228	229	230	231	127	128	129	130	131	132															134, 133, 234, 233, 232						
FFRE1517	XQKU15P	224	225	226	227	228	229	230	231	127	128	129	130	131	132															134, 133, 234, 233, 232						

Table 1-8: Transceiver Quad Migration (GTH Quads are White, GTY Quads are Gray, GTM Duals are Dark Gray) (Cont'd)

Package	Device	Package to Device Transceiver Mapping																										Unbonded GT Quads			
		A	B	C	D	E	F	G	H	I	J	K	L	M	N	O	P	Q	R	S	T	U	V	W	X	Y	Z		AA	AB	AC
Power Supply Group		RS						RN						LS				LN													
FFVA1760	XCKU15P	224	225	226	227	228	229	230	231	232	233	234	127	128	129	130	131	132	133	134											
Power Supply Group		RS						RN						L																	
FLVB1760	XCKU085	224	225	226	227	228	230	231	232			128	131	132								127,126,229									
	XCKU115	224	225	226	227	228	230	231	232	233	128	131	132	133							127,126,229										
FFVB1760	XCKU095	224	225	226	227	228	229	230	231			128	129	130	131							127,126,125,124									
	XCVU080	224	225	226	227	228	229	230	231			128	129	130	131							127,126,125,124									
	XCVU095	224	225	226	227	228	229	230	231			128	129	130	131							127,126,125,124									
FLVB1760	XCVU125	224	225	226	227	228	230	231	232	233	129	130	131	132							133, 128, 127, 126, 125, 229										
Power Supply Group		RS						RN						L																	
FFVE1760	XCKU15P	224	225	226	227	228	229	230	231	127	128	129	130	131	132							134, 133, 234, 233, 232									
Power Supply Group		RS						RN						LS				LN													
FLVD1924	XCKU115	224	225	226	227	231	232	233	126	127	128	131	132	133							230,229,228										
Power Supply Group		RS						RN						LS				LN													
FLVF1924	XCKU085	224	225	226	227	228	229	230	231	232		126	127	128	131			132													
	XCKU115	224	225	226	227	228	229	230	231	232	233	126	127	128	131		133	132													
RLF1924	XQKU115	224	225	226	227	228	229	230	231	232	233	126	127	128	131		133	132													
FLGF1924	XCVU11P	224	225	226	227	228	229	230	231	232	233	125	126	127	129		131	130							135, 134, 133, 132, 128, 124, 235, 234						

Table 1-8: Transceiver Quad Migration (GTH Quads are White, GTY Quads are Gray, GTM Duals are Dark Gray) (Cont'd)

Package	Device	Package to Device Transceiver Mapping																										Unbonded GT Quads								
		A	B	C	D	E	F	G	H	I	J	K	L	M	N	O	P	Q	R	S	T	U	V	W	X	Y	Z		AA	AB	AC	AD	AE	AF		
Power Supply Group		R				L																														
FSVH1924	XCVU31P	224	225	226	227	124	125	126	127																											
Power Supply Group		RS				RN				LS				LN																						
FFVA2104	XCVU080	224	225	226	227	228	229	230	125	126	127	128	129	130																			131, 124, 231			
	XCVU095	224	225	226	227	228	229	230	125	126	127	128	129	130																			131, 124, 231			
FLVA2104	XCKU115	224	225	226	227	231	232	233	126	127	128	131	132	133																			230, 229, 228			
	XCVU125	224	225	226	227	231	232	233	125	126	127	130	131	132																			133, 129, 128, 124, 230, 229, 228			
	XCVU5P	224	225	226	227	231	232	233	125	126	127	130	131	132																			133, 129, 128, 124, 230, 229, 228			
	XCVU7P	224	225	226	227	231	232	233	125	126	127	130	131	132																			133, 129, 128, 124, 230, 229, 228			
FLRA2104	XQVU7P	224	225	226	227	231	232	233	125	126	127	130	131	132																			133, 129, 128, 124, 230, 229, 228			
FLGA2104	XCVU9P	224	225	226	227	231	232	233	120	121	122	125	126	127																			133, 132, 131, 130, 129, 128, 124, 123, 119, 230, 229, 228, 223, 222, 221, 220, 219			
FHGA2104	XCVU13P	224	225	226	227	229	230	231	125	126	127	129	130	131																			135, 134, 133, 132, 128, 124, 123, 122, 121, 120, 235, 234, 233, 232, 228, 223, 222, 221, 220			

Table 1-8: Transceiver Quad Migration (GTH Quads are White, GTY Quads are Gray, GTM Duals are Dark Gray) (Cont'd)

Package	Device	Package to Device Transceiver Mapping																										Unbonded GT Quads						
		A	B	C	D	E	F	G	H	I	J	K	L	M	N	O	P	Q	R	S	T	U	V	W	X	Y	Z		AA	AB	AC	AD	AE	AF
Power Supply Group		RS						RN						LS				LN																
FFVB2104	XCKU095	224	225	226	227	228	229	230	231							124	125	126	127	128	129	130	131											
	XCVU080	224	225	226	227	228	229	230	231							124	125	126	127	128	129	130	131											
	XCVU095	224	225	226	227	228	229	230	231							124	125	126	127	128	129	130	131											
FLVB2104	XCKU115	224	225	226	227	228	229	230	231	232	233	126	127	128					131	132	133													
	XCVU125	224	225	226	227	228	229	230	231	232	233	125	126	127	128	129	130	131	132	133											124			
	XCVU5P	224	225	226	227	228	229	230	231	232	233	125	126	127	128	129	130	131	132	133											124			
	XCVU7P	224	225	226	227	228	229	230	231	232	233	125	126	127	128	129	130	131	132	133											124			
FLRB2104	XQVU7P	224	225	226	227	228	229	230	231	232	233	125	126	127	128	129	130	131	132	133											124			
FLGB2104	XCVU160	224	225	226	227	228	229	230	231	232	233	125	126	127	128	129	130	131	132	133											124, 123, 122, 121, 120, 223, 222, 221, 220			
	XCVU190	224	225	226	227	228	229	230	231	232	233	125	126	127	128	129	130	131	132	133											124, 123, 122, 121, 120, 119, 223, 222, 221, 220, 219			
	XCVU9P	224	225	226	227	228	229	230	231	232	233	120	121	122	123	124	125	126	127	128											133, 132, 131, 130, 129, 119, 223, 222, 221, 220, 219			
	XCVU11P	224	225	226	227	228	229	230	231	232	233	124	125	126	127	128	129	130	131	133											135, 134, 132, 235, 234			
FHGB2104	XCVU13P	224	225	226	227	228	229	230	231	232	233	124	125	126	127	128	129	130	131	133											135, 134, 132, 123, 122, 121, 120, 235, 234, 223, 222, 221, 220			

Table 1-8: Transceiver Quad Migration (GTH Quads are White, GTY Quads are Gray, GTM Duals are Dark Gray) (Cont'd)

Package	Device	Package to Device Transceiver Mapping																										Unbonded GT Quads				
		A	B	C	D	E	F	G	H	I	J	K	L	M	N	O	P	Q	R	S	T	U	V	W	X	Y	Z		AA	AB	AC	AD
Power Supply Group		RC					RN					RS			LC					LN					LS							
FFVC2104	XCVU095	224	225	226	227	228	229	230	231						124	125	126	127	128	129	130	131										
FLVC2104	XCVU125	224	225	226	227	228	229	230	231	232	233						124	125	126	127	128	129	130	131	132	133						
	XCVU5P	224	225	226	227	228	229	230	231	232	233						124	125	126	127	128	129	130	131	132	133						
	XCVU7P	224	225	226	227	228	229	230	231	232	233						124	125	126	127	128	129	130	131	132	133						
FLGC2104	XCVU160	224	225	226	227	228	229	230	231	232	233	220	221	222	124	125	126	127	128	129	130	131	132	133	120	121	122				123, 223	
	XCVU190	224	225	226	227	228	229	230	231	232	233	220	221	222	124	125	126	127	128	129	130	131	132	133	120	121	122				123, 119, 223, 219	
	XCVU9P	224	225	226	227	228	229	230	231	232	233	220	221	222	124	125	126	127	128	129	130	131	132	133	120	121	122				123, 119, 223, 219	
	XCVU11P	226	227	228	229	230	231	232	233	234	235				224	225	126	127	128	129	130	131	132	133	134	135						
FLRC2104	XQVU11P	226	227	228	229	230	231	232	233	234	235				224	225	126	127	128	129	130	131	132	133	134	135						
FHGC2104	XCVU13P	224	225	226	227	228	229	230	231	232	233	221	222	223	124	125	126	127	128	129	130	131	132	133	121	122	123				135, 134, 120, 235, 234, 220	

Table 1-8: Transceiver Quad Migration (GTH Quads are White, GTY Quads are Gray, GTM Duals are Dark Gray) (Cont'd)

Package	Device	Package to Device Transceiver Mapping																								Unbonded GT Quads							
		A	B	C	D	E	F	G	H	I	J	K	L	M	N	O	P	Q	R	S	T	U	V	W	X		Y	Z	AA	AB	AC	AD	AE
Power Supply Group		RS				RN				LS				LN																			
FSGD2104	XCVU9P	224	225	226	227	228	229	230	231	232	233	120	121	122	123	124	125	126	127	131													133, 132, 130, 129, 128, 119, 223, 222, 221, 220, 219
	XCVU11P	224	225	226	227	228	229	230	231	232	233	124	125	126	127	128	129	130	131	133													135, 134, 132, 235, 234
FIGD2104	XCVU13P	224	225	226	227	228	229	230	231	232	233	120	121	122	123	128	129	130	131	133													135, 134, 132, 127, 126, 125, 124, 235, 234, 223, 222, 221, 220
	XCVU27P	224	225	226	227	228	229	230	231	232	233	120	121	122	123	128	129	130	131	133													135, 134, 132, 127, 126, 125, 124, 235, 234, 223, 222, 221, 220
	XCVU29P	224	225	226	227	228	229	230	231	232	233	120	121	122	123	128	129	130	131	133													135, 134, 132, 127, 126, 125, 124, 235, 234, 223, 222, 221, 220
Power Supply Group		RS				RN				LS				LN																			
FSVH2104	XCVU33P	224	225	226	227					124	125	126	127																				
	XCVU35P	224	225	226	227	228	229	230	231	124	125	126	127	128	129	130	131																

Table 1-8: Transceiver Quad Migration (GTH Quads are White, GTY Quads are Gray, GTM Duals are Dark Gray) (Cont'd)

Package	Device	Package to Device Transceiver Mapping																										Unbonded GT Quads														
		A	B	C	D	E	F	G	H	I	J	K	L	M	N	O	P	Q	R	S	T	U	V	W	X	Y	Z		AA	AB	AC	AD	AE	AF								
Power Supply Group		RC			RN				RS																																	
FLGB2377	XCVU440	224	225	226	231	232	233	221	222	223																	233, 232, 231, 226, 225, 224, 223, 222, 221															
Power Supply Group		RLC			RUC				RN				RS			RLC	LLC			LUC				LN				LS			LLC											
FLGA2577	XCVU190	224	225	226	227	228	229	230	231	232	233		219	220	221	222	223	124	125	126	127	128	129	130	131	132	133		119	120	121	122	123									
	XCVU9P	224	225	226	227	228	229	230	231	232	233		219	220	221	222	223	124	125	126	127	128	129	130	131	132	133		119	120	121	122	123									
	XCVU11P	225	226	227	228	229	230	231	232	233	234	235					224	125	126	127	128	129	130	131	132	133	134	135					124									
	XCVU13P	225	226	227	228	229	230	231	232	233	234	235	220	221	222	223	224	125	126	127	128	129	130	131	132	133	134	135	120	121	122	123	124									
FSGA2577	XCVU13P	225	226	227	228	229	230	231	232	233	234	235	220	221	222	223	224	125	126	127	128	129	130	131	132	133	134	135	120	121	122	123	124									
	XCVU27P	225	226	227	228	229	230	231	232	233	234	235	220	221	222	223	224	125	126	127	128	129	130	131	132	133	134	135	120	121	122	123	124									
	XCVU29P	225	226	227	228	229	230	231	232	233	234	235	220	221	222	223	224	125	126	127	128	129	130	131	132	133	134	135	120	121	122	123	124									
Power Supply Group		RC			RN				RS																																	
FLGA2892	XCVU440	224	225	226	227	229	230	231	232	219	220	221	222																	233, 228, 223												
Power Supply Group		RS				RC				RN				LS				LC				LN																				
FSVH2892	XCVU35P	224	225	226	227	228	229	230	231					124	125	126	127	128	129	130	131																					
	XCVU37P	224	225	226	227	228	229	230	231	232	233	234	235	124	125	126	127	128	129	130	131	132	133	134	135																	

Die Level Bank Numbering Overview

Banking and Clocking Summary

- For each device, not all banks are bonded out in every package.

GTH/GTY/GTM Columns

- One GTH/GTY Quad = Four transceivers = Four GTHE3 or GTYE3 primitives.
- One GTM Dual = Two transceivers = Two GTME3 primitives
- Not all GT Quads/Duals are bonded out in every package.
- Also shown are quads/duals labeled with RCAL. This specifies the location of the RCAL masters for each device. With respect to the package, the RCAL masters are located on the same package pin for each package, regardless of the device.
- The XY coordinates shown in each quad/dual correspond to the transceiver channel number found in the pin names for that quad/dual, as shown in [Figure 1-1](#).
- An alphabetic designator is shown in each quad/dual. Each letter corresponds to the columns in [Table 1-7](#) and [Table 1-8](#).
- The power supply group is shown in brackets [] for each quad/dual.

I/O Banks

- Each user I/O bank has a total of 52 I/Os where 48 can be used as differential (24 differential pairs) or single-ended I/Os. The remaining four function only as single-ended I/Os. All 52 pads of a bank are not always bonded out to pins.
- A limited number of banks have fewer than 52 SelectIO pins. These banks are labeled as partial.
- Adjacent to each bank is a physical layer (PHY) containing a CMT and other clock resources.
- Adjacent to each bank and PHY is a tile of logic resources that makes up a clock region.
- Banks are arranged in columns and separated into rows which are pitch-matched with adjacent PHY, clock regions, and GT blocks.
- An alphabetic designator is shown in each bank. Each letter corresponds to the columns in [Table 1-7](#) and [Table 1-8](#).

Clocking

- Each bank has four pairs of global clock (GC) inputs for four differential or four single-ended clock inputs. Single-ended clock inputs should be connected to the P side of the differential pair.
- Clock signals are distributed through global buffers driving routing and distribution networks to reach any clock region, I/O, or GT.
- Global clock inputs can connect to an MMCM and two PLLs within the horizontally adjacent CMT.

Bank Locations of Dedicated and Multi-Function Pins

- In all UltraScale and UltraScale+ devices, bank 65 contains the multi-function configuration pins. Bank 0 contains the dedicated configuration pins.
- In [Figure 1-2](#) through [Figure 1-115](#), the multi-function configuration bank 65 is shown adjacent to the SYSMON/CFG blocks. For devices with multiple super logic regions (SLRs), banks 60 and 70 are also shown adjacent to the SYSMON/CFG blocks. Due to the architectural differences between these and other banks, special consideration must be taken when using them under certain conditions. See the [State of I/Os During and After Configuration](#) and the [Special DCI Requirements in Some Banks](#) sections of *UltraScale Architecture SelectIO Resources User Guide* (UG571) [\[Ref 5\]](#) for details.
- For UltraScale devices, all dedicated configuration I/Os (bank 0) and HR I/Os are 1.5V to 3.3V capable.
- For UltraScale+ devices, all dedicated configuration I/Os (bank 0) and HR I/Os are 1.5V to 1.8V capable.

SYSMON, Configuration, PCIe, Interlaken, and 100GE Integrated Blocks

- CFG: Configuration block
- SYSMON/CFG: Block shared between SYSMON and configuration
- PCIe: Integrated block for PCIe

Note: Do not connect the Integrated block for PCIe to transceiver channels through an SLR crossing. For further details, refer to the *Placement Rules* section of the *UltraScale Devices Gen3 Integrated Block for PCI Express Product Guide* (PG156) [\[Ref 14\]](#) and *UltraScale+ Devices Integrated Block for PCI Express Product Guide* (PG213) [\[Ref 15\]](#). PCIe blocks with an additional (Tandem) label support tandem configuration.

- ILKN: Interlaken block

Note: Do not connect the Interlaken block to transceiver channels through an SLR crossing. For further details, refer to the *Transceiver Interface* section of the *Integrated Interlaken 150G Product Guide* (PG169) [\[Ref 16\]](#).

- CMAC: 100G Ethernet block

Note: Do not connect the 100G Ethernet block to transceiver channels through an SLR crossing. For further details, refer to the *Transceiver Selection Rules* section of the *UltraScale Devices Integrated Block for 100G Ethernet Product Guide* (PG165) [Ref 17] or *UltraScale+ Devices Integrated 100G Ethernet Subsystem Product Guide* (PG203) [Ref 18].

Device Diagrams

Figure 1-1 shows an example diagram with a brief explanation for each component.

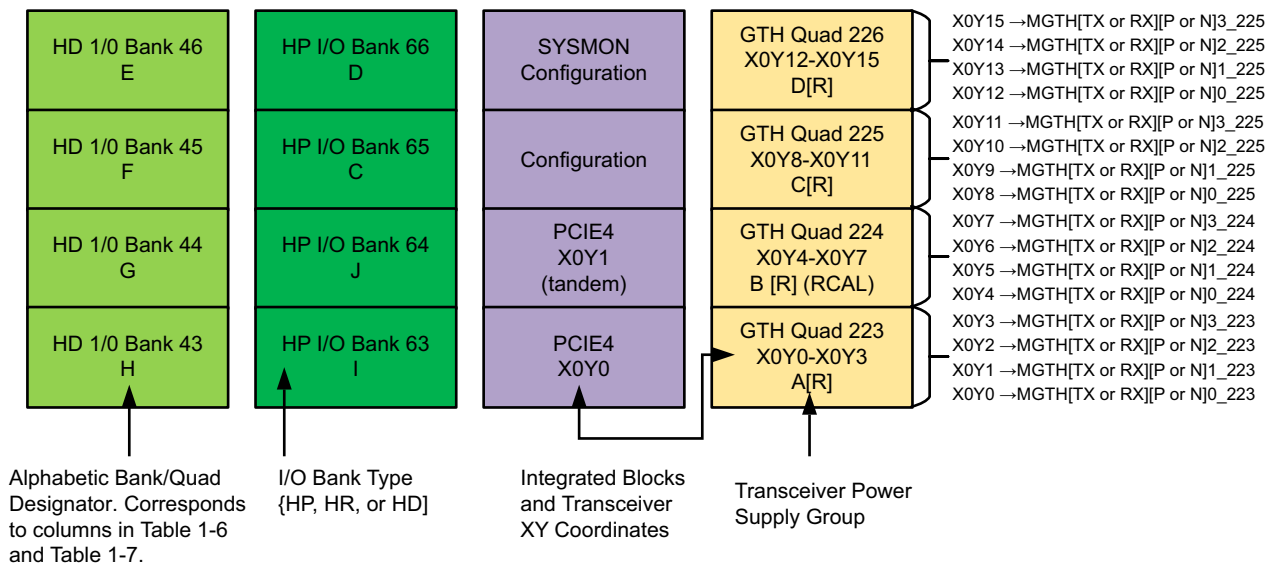

X16518-012717

Figure 1-1: Example Device Diagram



TIP: Due to design limitations, the device resources might be less than what is shown in the device diagrams. The actual available resources by device and package are listed in the *UltraScale Architecture and Product Overview (DS890)* [Ref 1].

The following figures show a die view of each device followed by a view with respect to each available package.

XCKU025 Bank Diagrams

HP I/O Bank 46	HP I/O Bank 66	SYSMON Configuration	GTH Quad 226 X0Y8-X0Y11
HP I/O Bank 45	HR I/O Bank 65	Configuration	GTH Quad 225 X0Y4-X0Y7 (RCAL)
HP I/O Bank 44	HR I/O Bank 64	PCIe X0Y0 (tandem)	GTH Quad 224 X0Y0-X0Y3

X16426-012917

Figure 1-2: XCKU025 Banks

HP I/O Bank 46 I	HP I/O Bank 66 D	SYSMON Configuration	GTH Quad 226 X0Y8-X0Y11 C [R]
HP I/O Bank 45 H	HR I/O Bank 65 C	Configuration	GTH Quad 225 X0Y4-X0Y7 B [R] (RCAL)
HP I/O Bank 44 G	HR I/O Bank 64 R	PCIe X0Y0 (tandem)	GTH Quad 224 X0Y0-X0Y3 A [R]

X16427-012917

Figure 1-3: XCKU025 Banks in FFVA1156 Package

XCKU035 Bank Diagrams

HP I/O Bank 48	HP I/O Bank 68	PCIe X0Y2	GTH Quad 228 X0Y16-X0Y19
HP I/O Bank 47	HP I/O Bank 67	PCIe X0Y1	GTH Quad 227 X0Y12-X0Y15
HP I/O Bank 46	HP I/O Bank 66	SYSMON Configuration	GTH Quad 226 X0Y8-X0Y11
HP I/O Bank 45	HR I/O Bank 65	Configuration	GTH Quad 225 X0Y4-X0Y7 (RCAL)
HP I/O Bank 44	HR I/O Bank 64	PCIe X0Y0 (tandem)	GTH Quad 224 X0Y0-X0Y3

X16429-012917

Figure 1-4: XCKU035 Banks

HP I/O Bank 48	HP I/O Bank 68	PCIe X0Y2	GTH Quad 228 X0Y16-X0Y19
HP I/O Bank 47	HP I/O Bank 67	PCIe X0Y1	GTH Quad 227 X0Y12-X0Y15 D [R]
HP I/O Bank 46 G	HP I/O Bank 66 D	SYSMON Configuration	GTH Quad 226 X0Y8-X0Y11 C [R]
HP I/O Bank 45 F	HR I/O Bank 65 C	Configuration	GTH Quad 225 X0Y4-X0Y7 B [R] (RCAL)
HP I/O Bank 44 E	HR I/O Bank 64 R	PCIe X0Y0 (tandem)	GTH Quad 224 X0Y0-X0Y3 A [R]

X16430-012917

Figure 1-5: XCKU035 Banks in FBVA676 Package

HP I/O Bank 48	HP I/O Bank 68 I	PCIe X0Y2	GTH Quad 228 X0Y16-X0Y19
HP I/O Bank 47 G	HP I/O Bank 67 J	PCIe X0Y1	GTH Quad 227 X0Y12-X0Y15
HP I/O Bank 46 F	HP I/O Bank 66 H	SYSMON Configuration	GTH Quad 226 X0Y8-X0Y11
HP I/O Bank 45 E	HR I/O Bank 65 C	Configuration	GTH Quad 225 X0Y4-X0Y7 B [R] (RCAL)
HP I/O Bank 44 D	HR I/O Bank 64 R	PCIe X0Y0 (tandem)	GTH Quad 224 X0Y0-X0Y3 A [R]

X16432-012917

Figure 1-6: XCKU035 Banks in SFVA784 Package

HP I/O Bank 48 J	HP I/O Bank 68	PCIe X0Y2	GTH Quad 228 X0Y16-X0Y19
HP I/O Bank 47 I	HP I/O Bank 67 E	PCIe X0Y1	GTH Quad 227 X0Y12-X0Y15 D [R]
HP I/O Bank 46 H	HP I/O Bank 66 D	SYSMON Configuration	GTH Quad 226 X0Y8-X0Y11 C [R]
HP I/O Bank 45 G	HR I/O Bank 65 C	Configuration	GTH Quad 225 X0Y4-X0Y7 B [R] (RCAL)
HP I/O Bank 44 F	HR I/O Bank 64 R	PCIe X0Y0 (tandem)	GTH Quad 224 X0Y0-X0Y3 A [R]

X16433-012917

Figure 1-7: XCKU035 Banks in FBVA900 Package

HP I/O Bank 48 K	HP I/O Bank 68 F	PCIe X0Y2	GTH Quad 228 X0Y16-X0Y19
HP I/O Bank 47 J	HP I/O Bank 67 E	PCIe X0Y1	GTH Quad 227 X0Y12-X0Y15 D [R]
HP I/O Bank 46 I	HP I/O Bank 66 D	SYSMON Configuration	GTH Quad 226 X0Y8-X0Y11 C [R]
HP I/O Bank 45 H	HR I/O Bank 65 C	Configuration	GTH Quad 225 X0Y4-X0Y7 B [R] (RCAL)
HP I/O Bank 44 G	HR I/O Bank 64 R	PCIe X0Y0 (tandem)	GTH Quad 224 X0Y0-X0Y3 A [R]

X16434-062117

Figure 1-8: XCKU035 Banks in FFVA1156 Package

XCKU040 and XQKU040 Bank Diagrams

HP I/O Bank 48	HP I/O Bank 68	PCle X0Y2	GTH Quad 228 X0Y16-X0Y19
HP I/O Bank 47	HP I/O Bank 67	PCle X0Y1	GTH Quad 227 X0Y12-X0Y15
HP I/O Bank 46	HP I/O Bank 66	SYSMON Configuration	GTH Quad 226 X0Y8-X0Y11
HP I/O Bank 45	HR I/O Bank 65	Configuration	GTH Quad 225 X0Y4-X0Y7 (RCAL)
HP I/O Bank 44	HR I/O Bank 64	PCle X0Y0 (tandem)	GTH Quad 224 X0Y0-X0Y3

X16435-012917

Figure 1-9: XCKU040 and XQKU040 Banks

HP I/O Bank 48	HP I/O Bank 68	PCle X0Y2	GTH Quad 228 X0Y16-X0Y19
HP I/O Bank 47	HP I/O Bank 67	PCle X0Y1	GTH Quad 227 X0Y12-X0Y15 D [R]
HP I/O Bank 46 G	HP I/O Bank 66 D	SYSMON Configuration	GTH Quad 226 X0Y8-X0Y11 C [R]
HP I/O Bank 45 F	HR I/O Bank 65 C	Configuration	GTH Quad 225 X0Y4-X0Y7 B [R] (RCAL)
HP I/O Bank 44 E	HR I/O Bank 64 R	PCle X0Y0 (tandem)	GTH Quad 224 X0Y0-X0Y3 A [R]

X16436-012917

Figure 1-10: XCKU040 Banks in FBVA676 Package and XQKU040 Banks in RBA676 Package

HP I/O Bank 48	HP I/O Bank 68 I	PCIe X0Y2	GTH Quad 228 X0Y16-X0Y19
HP I/O Bank 47 G	HP I/O Bank 67 J	PCIe X0Y1	GTH Quad 227 X0Y12-X0Y15
HP I/O Bank 46 F	HP I/O Bank 66 H	SYSMON Configuration	GTH Quad 226 X0Y8-X0Y11
HP I/O Bank 45 E	HR I/O Bank 65 C	Configuration	GTH Quad 225 X0Y4-X0Y7 B [R] (RCAL)
HP I/O Bank 44 D	HR I/O Bank 64 R	PCIe X0Y0 (tandem)	GTH Quad 224 X0Y0-X0Y3 A [R]

X16437-012917

Figure 1-11: XCKU040 Banks in SFVA784 Package

HP I/O Bank 48 J	HP I/O Bank 68	PCIe X0Y2	GTH Quad 228 X0Y16-X0Y19
HP I/O Bank 47 I	HP I/O Bank 67 E	PCIe X0Y1	GTH Quad 227 X0Y12-X0Y15 D [R]
HP I/O Bank 46 H	HP I/O Bank 66 D	SYSMON Configuration	GTH Quad 226 X0Y8-X0Y11 C [R]
HP I/O Bank 45 G	HR I/O Bank 65 C	Configuration	GTH Quad 225 X0Y4-X0Y7 B [R] (RCAL)
HP I/O Bank 44 F	HR I/O Bank 64 R	PCIe X0Y0 (tandem)	GTH Quad 224 X0Y0-X0Y3 A [R]

X16438-012917

Figure 1-12: XCKU040 Banks in FBVA900 Package

HP I/O Bank 48 K	HP I/O Bank 68 F	PCIe X0Y2	GTH Quad 228 X0Y16-X0Y19 E [R]
HP I/O Bank 47 J	HP I/O Bank 67 E	PCIe X0Y1	GTH Quad 227 X0Y12-X0Y15 D [R]
HP I/O Bank 46 I	HP I/O Bank 66 D	SYSMON Configuration	GTH Quad 226 X0Y8-X0Y11 C [R]
HP I/O Bank 45 H	HR I/O Bank 65 C	Configuration	GTH Quad 225 X0Y4-X0Y7 B [R] (RCAL)
HP I/O Bank 44 G	HR I/O Bank 64 R	PCIe X0Y0 (tandem)	GTH Quad 224 X0Y0-X0Y3 A [R]

X16439-062117

Figure 1-13: XCKU040 Banks in FFVA1156 Package and XQKU040 in RFA1156 Package

XCKU060 and XQKU060 Bank Diagrams

GTH Quad 128 X0Y16-X0Y19 (RCAL)	HP I/O Bank 48	HP I/O Bank 68	PCIe X0Y2	GTH Quad 228 X1Y16-X1Y19
GTH Quad 127 X0Y12-X0Y15	HP I/O Bank 47	HP I/O Bank 67	PCIe X0Y1	GTH Quad 227 X1Y12-X1Y15
GTH Quad 126 X0Y8-X0Y11	HP I/O Bank 46	HP I/O Bank 66	SYSMON Configuration	GTH Quad 226 X1Y8-X1Y11 (RCAL)
HP I/O Bank 25	HP I/O Bank 45	HR I/O Bank 65	Configuration	GTH Quad 225 X1Y4-X1Y7
HP I/O Bank 24	HP I/O Bank 44	HR I/O Bank 64	PCIe X0Y0 (tandem)	GTH Quad 224 X1Y0-X1Y3

X16440-012917

Figure 1-14: XCKU060 and XQKU060 Banks

GTH Quad 128 X0Y16-X0Y19 G [L] (RCAL)	HP I/O Bank 48 K	HP I/O Bank 68 F	PCIe X0Y2	GTH Quad 228 X1Y16-X1Y19 E [R]
GTH Quad 127 X0Y12-X0Y15 F [L]	HP I/O Bank 47 J	HP I/O Bank 67 E	PCIe X0Y1	GTH Quad 227 X1Y12-X1Y15 D [R]
GTH Quad 126 X0Y8-X0Y11	HP I/O Bank 46 I	HP I/O Bank 66 D	SYSMON Configuration	GTH Quad 226 X1Y8-X1Y11 C [R] (RCAL)
HP I/O Bank 25	HP I/O Bank 45 H	HR I/O Bank 65 C	Configuration	GTH Quad 225 X1Y4-X1Y7 B [R]
HP I/O Bank 24	HP I/O Bank 44 G	HR I/O Bank 64 R	PCIe X0Y0 (tandem)	GTH Quad 224 X1Y0-X1Y3 A [R]

X16441-062117

Figure 1-15: XCKU060 Banks in FFVA1156 Package and XQKU060 Banks in RFA1156 Package

GTH Quad 128 X0Y16-X0Y19 L [L] (RCAL)	HP I/O Bank 48 M	HP I/O Bank 68 J	PCIe X0Y2	GTH Quad 228 X1Y16-X1Y19 E [RS]
GTH Quad 127 X0Y12-X0Y15 K [L]	HP I/O Bank 47 L	HP I/O Bank 67 I	PCIe X0Y1	GTH Quad 227 X1Y12-X1Y15 D [RS]
GTH Quad 126 X0Y8-X0Y11 J [L]	HP I/O Bank 46 K	HP I/O Bank 66 H	SYSMON Configuration	GTH Quad 226 X1Y8-X1Y11 C [RS] (RCAL)
HP I/O Bank 25 G	HP I/O Bank 45 E	HR I/O Bank 65 C	Configuration	GTH Quad 225 X1Y4-X1Y7 B [RS]
HP I/O Bank 24 F	HP I/O Bank 44 D	HR I/O Bank 64 R	PCIe X0Y0 (tandem)	GTH Quad 224 X1Y0-X1Y3 A [RS]

X16442-012917

Figure 1-16: XCKU060 Banks in FFVA1517 Package

XCKU085 Bank Diagrams

GTH Quad 132 X0Y32-X0Y35	HP I/O Bank 52	HP I/O Bank 72	PCIe X0Y4	GTH Quad 232 X1Y32-X1Y35
GTH Quad 131 X0Y28-X0Y31	HP I/O Bank 51	HP I/O Bank 71	SYSMON Configuration	GTH Quad 231 X1Y28-X1Y31 (RCAL)
HP I/O Bank 30	HP I/O Bank 50	HR I/O Bank 70	Configuration	GTH Quad 230 X1Y24-X1Y27
HP I/O Bank 29	HP I/O Bank 49	HR I/O Bank 69	PCIe X0Y3	GTH Quad 229 X1Y20-X1Y23
SLR Crossing				
GTH Quad 128 X0Y16-X0Y19 (RCAL)	HP I/O Bank 48	HP I/O Bank 68	PCIe X0Y2	GTH Quad 228 X1Y16-X1Y19
GTH Quad 127 X0Y12-X0Y15	HP I/O Bank 47	HP I/O Bank 67	PCIe X0Y1	GTH Quad 227 X1Y12-X1Y15
GTH Quad 126 X0Y8-X0Y11	HP I/O Bank 46	HP I/O Bank 66	SYSMON Configuration	GTH Quad 226 X1Y8-X1Y11 (RCAL)
HP I/O Bank 25	HP I/O Bank 45	HR I/O Bank 65	Configuration	GTH Quad 225 X1Y4-X1Y7
HP I/O Bank 24	HP I/O Bank 44	HR I/O Bank 64	PCIe X0Y0 (tandem)	GTH Quad 224 X1Y0-X1Y3

X16443-012917

Figure 1-17: XCKU085 Banks

GTH Quad 132 X0Y32-X0Y35	HP I/O Bank 52	HP I/O Bank 72	PCle X0Y4	GTH Quad 232 X1Y32-X1Y35 I [RN]
GTH Quad 131 X0Y28-X0Y31	HP I/O Bank 51	HP I/O Bank 71	SYSMON Configuration	GTH Quad 231 X1Y28-X1Y31 H [RN] (RCAL)
HP I/O Bank 30	HP I/O Bank 50	HR I/O Bank 70	Configuration	GTH Quad 230 X1Y24-X1Y27 G [RN]
HP I/O Bank 29	HP I/O Bank 49	HR I/O Bank 69	PCle X0Y3	GTH Quad 229 X1Y20-X1Y23 F [RN]
SLR Crossing				
GTH Quad 128 X0Y16-X0Y19 L [L] (RCAL)	HP I/O Bank 48 M	HP I/O Bank 68 J	PCle X0Y2	GTH Quad 228 X1Y16-X1Y19 E [RS]
GTH Quad 127 X0Y12-X0Y15 K [L]	HP I/O Bank 47 L	HP I/O Bank 67 I	PCle X0Y1	GTH Quad 227 X1Y12-X1Y15 D [RS]
GTH Quad 126 X0Y8-X0Y11 J [L]	HP I/O Bank 46 K	HP I/O Bank 66 H	SYSMON Configuration	GTH Quad 226 X1Y8-X1Y11 C [RS] (RCAL)
HP I/O Bank 25 G	HP I/O Bank 45 E	HR I/O Bank 65 C	Configuration	GTH Quad 225 X1Y4-X1Y7 B [RS]
HP I/O Bank 24 F	HP I/O Bank 44 D	HR I/O Bank 64 R	PCle X0Y0 (tandem)	GTH Quad 224 X1Y0-X1Y3 A [RS]

X16444-012917

Figure 1-18: XCKU085 Banks in FLVA1517 Package

GTH Quad 132 X0Y32-X0Y35 L [L]	HP I/O Bank 52 N	HP I/O Bank 72	PCle X0Y4	GTH Quad 232 X1Y32-X1Y35 H [RN]
GTH Quad 131 X0Y28-X0Y31 K [L]	HP I/O Bank 51 M	HP I/O Bank 71	SYSMON Configuration	GTH Quad 231 X1Y28-X1Y31 G [RN] (RCAL)
HP I/O Bank 30	HP I/O Bank 50 L	HR I/O Bank 70	Configuration	GTH Quad 230 X1Y24-X1Y27 F [RN]
HP I/O Bank 29	HP I/O Bank 49 K	HR I/O Bank 69	PCle X0Y3	GTH Quad 229 X1Y20-X1Y23
SLR Crossing				
GTH Quad 128 X0Y16-X0Y19 J [L] (RCAL)	HP I/O Bank 48 J	HP I/O Bank 68	PCle X0Y2	GTH Quad 228 X1Y16-X1Y19 E [RS]
GTH Quad 127 X0Y12-X0Y15	HP I/O Bank 47 I	HP I/O Bank 67 E	PCle X0Y1	GTH Quad 227 X1Y12-X1Y15 D [RS]
GTH Quad 126 X0Y8-X0Y11	HP I/O Bank 46 H	HP I/O Bank 66 D	SYSMON Configuration	GTH Quad 226 X1Y8-X1Y11 C [RS] (RCAL)
HP I/O Bank 25	HP I/O Bank 45 G	HR I/O Bank 65 C	Configuration	GTH Quad 225 X1Y4-X1Y7 B [RS]
HP I/O Bank 24	HP I/O Bank 44 F	HR I/O Bank 84/94 B	PCle X0Y0 (tandem)	GTH Quad 224 X1Y0-X1Y3 A [RS]

X16445-012917

Figure 1-19: XCKU085 Banks in FLVB1760 Package

GTH Quad 132 X0Y32-X0Y35 O [LN]	HP I/O Bank 52 K	HP I/O Bank 72 O	PCle X0Y4	GTH Quad 232 X1Y32-X1Y35 I [RN]
GTH Quad 131 X0Y28-X0Y31 N [LN]	HP I/O Bank 51 J	HP I/O Bank 71 N	SYSMON Configuration	GTH Quad 231 X1Y28-X1Y31 H [RN] (RCAL)
HP I/O Bank 30	HP I/O Bank 50	HR I/O Bank 70 M	Configuration	GTH Quad 230 X1Y24-X1Y27 G [RN]
HP I/O Bank 29	HP I/O Bank 49	HR I/O Bank 69	PCle X0Y3	GTH Quad 229 X1Y20-X1Y23 F [RN]
SLR Crossing				
GTH Quad 128 X0Y16-X0Y19 M [LS] (RCAL)	HP I/O Bank 48	HP I/O Bank 68 F	PCle X0Y2	GTH Quad 228 X1Y16-X1Y19 E [RS]
GTH Quad 127 X0Y12-X0Y15 L [LS]	HP I/O Bank 47	HP I/O Bank 67 E	PCle X0Y1	GTH Quad 227 X1Y12-X1Y15 D [RS]
GTH Quad 126 X0Y8-X0Y11 K [LS]	HP I/O Bank 46 I	HP I/O Bank 66 D	SYSMON Configuration	GTH Quad 226 X1Y8-X1Y11 C [RS] (RCAL)
HP I/O Bank 25	HP I/O Bank 45 H	HR I/O Bank 65 C	Configuration	GTH Quad 225 X1Y4-X1Y7 B [RS]
HP I/O Bank 24	HP I/O Bank 44 G	HR I/O Bank 84/94	PCle X0Y0 (tandem)	GTH Quad 224 X1Y0-X1Y3 A [RS]

X16446-012917

Figure 1-20: XCKU085 Banks in FLVF1924 Package

XCKU095 and XQKU095 Bank Diagrams

GTU Quad 131 X0Y28-X0Y31		HP I/O Bank 51	HP I/O Bank 71	PCIe X0Y3	GTH Quad 231 X0Y28-X0Y31
GTU Quad 130 X0Y24-X0Y27		HP I/O Bank 50	HP I/O Bank 70	ILKN X0Y2	GTH Quad 230 X0Y24-X0Y27
GTU Quad 129 X0Y20-X0Y23 (RCAL)	CMAC X0Y1	HP I/O Bank 49	HP I/O Bank 69	PCIe X0Y2	GTH Quad 229 X0Y20-X0Y23
GTU Quad 128 X0Y16-X0Y19		HP I/O Bank 48	HP I/O Bank 68	PCIe X0Y1	GTH Quad 228 X0Y16-X0Y19
GTU Quad 127 X0Y12-X0Y15	CMAC X0Y0	HP I/O Bank 47	HP I/O Bank 67	ILKN X0Y0	GTH Quad 227 X0Y12-X0Y15
GTU Quad 126 X0Y8-X0Y11		HP I/O Bank 46	HP I/O Bank 66	SYSMON Configuration	GTH Quad 226 X0Y8-X0Y11
GTU Quad 125 X0Y4-X0Y7		HP I/O Bank 45	HP I/O Bank 65	Configuration	GTH Quad 225 X0Y4-X0Y7 (RCAL)
GTU Quad 124 X0Y0-X0Y3		HP I/O Bank 44	HR I/O Bank 84/94	PCIe X0Y0 (tandem)	GTH Quad 224 X0Y0-X0Y3

X16448-012917

Figure 1-21: XCKU095 and XQKU095 Banks

GTU Quad 131 X0Y28-X0Y31		HP I/O Bank 51	HP I/O Bank 71	PCIe X0Y3	GTH Quad 231 X0Y28-X0Y31
GTU Quad 130 X0Y24-X0Y27 G [L]		HP I/O Bank 50	HP I/O Bank 70	ILKN X0Y2	GTH Quad 230 X0Y24-X0Y27
GTU Quad 129 X0Y20-X0Y23 F [L] (RCAL)	CMAC X0Y1	HP I/O Bank 49	HP I/O Bank 69	PCIe X0Y2	GTH Quad 229 X0Y20-X0Y23
GTU Quad 128 X0Y16-X0Y19		HP I/O Bank 48 K	HP I/O Bank 68 D	PCIe X0Y1	GTH Quad 228 X0Y16-X0Y19 E [R]
GTU Quad 127 X0Y12-X0Y15	CMAC X0Y0	HP I/O Bank 47 J	HP I/O Bank 67 F	ILKN X0Y0	GTH Quad 227 X0Y12-X0Y15 D [R]
GTU Quad 126 X0Y8-X0Y11		HP I/O Bank 46 I	HP I/O Bank 66 D	SYSMON Configuration	GTH Quad 226 X0Y8-X0Y11 C [R]
GTU Quad 125 X0Y4-X0Y7		HP I/O Bank 45 G	HP I/O Bank 65 C	Configuration	GTH Quad 225 X0Y4-X0Y7 B [R] (RCAL)
GTU Quad 124 X0Y0-X0Y3		HP I/O Bank 44 H	HR I/O Bank 64 R	PCIe X0Y0 (tandem)	GTH Quad 224 X0Y0-X0Y3 A [R]

X16449-012917

Figure 1-22: XCKU095 Banks in FFVA1156 Package and XQKU095 in RFA1156 Package

GTU Quad 131 X0Y28-X0Y31		HP I/O Bank 51	HP I/O Bank 71	PCIe X0Y3	GTH Quad 231 X0Y28-X0Y31
GTU Quad 130 X0Y24-X0Y27		HP I/O Bank 50	HP I/O Bank 70	ILKN X0Y2	GTH Quad 230 X0Y24-X0Y27
GTU Quad 129 X0Y20-X0Y23 J [L] (RCAL)	CMAC X0Y1	HP I/O Bank 49	HP I/O Bank 69	PCIe X0Y2	GTH Quad 229 X0Y20-X0Y23
GTU Quad 128 X0Y16-X0Y19 I [L]		HP I/O Bank 48 K	HP I/O Bank 68 F	PCIe X0Y1	GTH Quad 228 X0Y16-X0Y19 E [R]
GTU Quad 127 X0Y12-X0Y15 H [L]	CMAC X0Y0	HP I/O Bank 47 J	HP I/O Bank 67 E	ILKN X0Y0	GTH Quad 227 X0Y12-X0Y15 D [R]
GTU Quad 126 X0Y8-X0Y11 G [L]		HP I/O Bank 46 I	HP I/O Bank 66 D	SYSMON Configuration	GTH Quad 226 X0Y8-X0Y11 C [R]
GTU Quad 125 X0Y4-X0Y7 F [L]		HP I/O Bank 45 H	HP I/O Bank 65 C	Configuration	GTH Quad 225 X0Y4-X0Y7 B [R] (RCAL)
GTU Quad 124 X0Y0-X0Y3		HP I/O Bank 44 G	HR I/O Bank 84/94 B	PCIe X0Y0 (tandem)	GTH Quad 224 X0Y0-X0Y3 A [R]

X16450-012917

Figure 1-23: XCKU095 Banks in FFVC1517 Package

GTU Quad 131 X0Y28-X0Y31 M [L]		HP I/O Bank 51 O (Partial)	HP I/O Bank 71 L	PCle X0Y3	GTH Quad 231 X0Y28-X0Y31 H [RN]
GTU Quad 130 X0Y24-X0Y27 L [L]		HP I/O Bank 50 N	HP I/O Bank 70 K	ILKN X0Y2	GTH Quad 230 X0Y24-X0Y27 G [RN]
GTU Quad 129 X0Y20-X0Y23 K [L] (RCAL)	CMAC X0Y1	HP I/O Bank 49 M	HP I/O Bank 69	PCle X0Y2	GTH Quad 229 X0Y20-X0Y23 F [RN]
GTU Quad 128 X0Y16-X0Y19 J [L]		HP I/O Bank 48 J	HP I/O Bank 68	PCle X0Y1	GTH Quad 228 X0Y16-X0Y19 E [RS]
GTU Quad 127 X0Y12-X0Y15	CMAC X0Y0	HP I/O Bank 47 I	HP I/O Bank 67 E	ILKN X0Y0	GTH Quad 227 X0Y12-X0Y15 D [RS]
GTU Quad 126 X0Y8-X0Y11		HP I/O Bank 46 H	HP I/O Bank 66 D	SYSMON Configuration	GTH Quad 226 X0Y8-X0Y11 C [RS]
GTU Quad 125 X0Y4-X0Y7		HP I/O Bank 45 G	HP I/O Bank 65 C	Configuration	GTH Quad 225 X0Y4-X0Y7 B [RS] (RCAL)
GTU Quad 124 X0Y0-X0Y3		HP I/O Bank 44 F	HR I/O Bank 84/94 B	PCle X0Y0 (tandem)	GTH Quad 224 X0Y0-X0Y3 A [RS]

X16451-012917

Figure 1-24: XCKU095 Banks in FFVB1760 Package

GTU Quad 131 X0Y28-X0Y31 R [LN]		HP I/O Bank 51 L	HP I/O Bank 71 O	PCIe X0Y3	GTH Quad 231 X0Y28-X0Y31 H [RN]
GTU Quad 130 X0Y24-X0Y27 Q [LN]		HP I/O Bank 50 K	HP I/O Bank 70 N	ILKN X0Y2	GTH Quad 230 X0Y24-X0Y27 G [RN]
GTU Quad 129 X0Y20-X0Y23 P [LN] (RCAL)	CMAC X0Y1	HP I/O Bank 49 J	HP I/O Bank 69 M	PCIe X0Y2	GTH Quad 229 X0Y20-X0Y23 F [RN]
GTU Quad 128 X0Y16-X0Y19 O [LN]		HP I/O Bank 48	HP I/O Bank 68 F (Partial)	PCIe X0Y1	GTH Quad 228 X0Y16-X0Y19 E [RS]
GTU Quad 127 X0Y12-X0Y15 N [LS]	CMAC X0Y0	HP I/O Bank 47	HP I/O Bank 67 E	ILKN X0Y0	GTH Quad 227 X0Y12-X0Y15 D [RS]
GTU Quad 126 X0Y8-X0Y11 M [LS]		HP I/O Bank 46 I	HP I/O Bank 66 D	SYSMON Configuration	GTH Quad 226 X0Y8-X0Y11 C [RS]
GTU Quad 125 X0Y4-X0Y7 L [LS]		HP I/O Bank 45 H	HP I/O Bank 65 C	Configuration	GTH Quad 225 X0Y4-X0Y7 B [RS] (RCAL)
GTU Quad 124 X0Y0-X0Y3 K [LS]		HP I/O Bank 44 G	HR I/O Bank 84/94 B	PCIe X0Y0 (tandem)	GTH Quad 224 X0Y0-X0Y3 A [RS]

X16452-012917

Figure 1-25: XCKU095 Banks in FFVB2104 Package

XCKU115 and XQKU115 Bank Diagrams

GTH Quad 133 X0Y36-X0Y39 (RCAL)	HP I/O Bank 53	HP I/O Bank 73	PCle X0Y5	GTH Quad 233 X1Y36-X1Y39
GTH Quad 132 X0Y32-X0Y35	HP I/O Bank 52	HP I/O Bank 72	PCle X0Y4	GTH Quad 232 X1Y32-X1Y35
GTH Quad 131 X0Y28-X0Y31	HP I/O Bank 51	HP I/O Bank 71	SYSMON Configuration	GTH Quad 231 X1Y28-X1Y31 (RCAL)
HP I/O Bank 30	HP I/O Bank 50	HR I/O Bank 70	Configuration	GTH Quad 230 X1Y24-X1Y27
HP I/O Bank 29	HP I/O Bank 49	HR I/O Bank 69	PCle X0Y3	GTH Quad 229 X1Y20-X1Y23
SLR Crossing				
GTH Quad 128 X0Y16-X0Y19 (RCAL)	HP I/O Bank 48	HP I/O Bank 68	PCle X0Y2	GTH Quad 228 X1Y16-X1Y19
GTH Quad 127 X0Y12-X0Y15	HP I/O Bank 47	HP I/O Bank 67	PCle X0Y1	GTH Quad 227 X1Y12-X1Y15
GTH Quad 126 X0Y8-X0Y11	HP I/O Bank 46	HP I/O Bank 66	SYSMON Configuration	GTH Quad 226 X1Y8-X1Y11 (RCAL)
HP I/O Bank 25	HP I/O Bank 45	HR I/O Bank 65	Configuration	GTH Quad 225 X1Y4-X1Y7
HP I/O Bank 24	HP I/O Bank 44	HR I/O Bank 64	PCle X0Y0 (tandem)	GTH Quad 224 X1Y0-X1Y3

X16453-012917

Figure 1-26: XCKU115 and XQKU115 Banks



TIP: Bank 64 is labeled as 84/94 in some packages.

GTH Quad 133 X0Y36-X0Y39 (RCAL)	HP I/O Bank 53	HP I/O Bank 73	PCle X0Y5	GTH Quad 233 X1Y36-X1Y39
GTH Quad 132 X0Y32-X0Y35	HP I/O Bank 52	HP I/O Bank 72	PCle X0Y4	GTH Quad 232 X1Y32-X1Y35 I [RN]
GTH Quad 131 X0Y28-X0Y31	HP I/O Bank 51	HP I/O Bank 71	SYSMON Configuration	GTH Quad 231 X1Y28-X1Y31 H [RN] (RCAL)
HP I/O Bank 30	HP I/O Bank 50	HR I/O Bank 70	Configuration	GTH Quad 230 X1Y24-X1Y27 G [RN]
HP I/O Bank 29	HP I/O Bank 49	HR I/O Bank 69	PCle X0Y3	GTH Quad 229 X1Y20-X1Y23 F [RN]
SLR Crossing				
GTH Quad 128 X0Y16-X0Y19 L [L] (RCAL)	HP I/O Bank 48 M	HP I/O Bank 68 J	PCle X0Y2	GTH Quad 228 X1Y16-X1Y19 E [RS]
GTH Quad 127 X0Y12-X0Y15 K [L]	HP I/O Bank 47 L	HP I/O Bank 67 I	PCle X0Y1	GTH Quad 227 X1Y12-X1Y15 D [RS]
GTH Quad 126 X0Y8-X0Y11 J [L]	HP I/O Bank 46 K	HP I/O Bank 66 H	SYSMON Configuration	GTH Quad 226 X1Y8-X1Y11 C [RS] (RCAL)
HP I/O Bank 25 G	HP I/O Bank 45 E	HR I/O Bank 65 C	Configuration	GTH Quad 225 X1Y4-X1Y7 B [RS]
HP I/O Bank 24 F	HP I/O Bank 44 D	HR I/O Bank 64 R	PCle X0Y0 (tandem)	GTH Quad 224 X1Y0-X1Y3 A [RS]

X16454-012917

Figure 1-27: XCKU115 Banks in FLVA1517 Package

GTH Quad 133 X0Y36-X0Y39 R [LN] (RCAL)	HP I/O Bank 53	HP I/O Bank 73 H	PCle X0Y5	GTH Quad 233 X1Y36-X1Y39 J [RN]
GTH Quad 132 X0Y32-X0Y35 Q [LN]	HP I/O Bank 52	HP I/O Bank 72 G	PCle X0Y4	GTH Quad 232 X1Y32-X1Y35 I [RN]
GTH Quad 131 X0Y28-X0Y31 P [LN]	HP I/O Bank 51	HP I/O Bank 71 F	SYSMON Configuration	GTH Quad 231 X1Y28-X1Y31 H [RN] (RCAL)
HP I/O Bank 30	HP I/O Bank 50	HR I/O Bank 70	Configuration	GTH Quad 230 X1Y24-X1Y27 G [RN]
HP I/O Bank 29	HP I/O Bank 49	HR I/O Bank 69	PCle X0Y3	GTH Quad 229 X1Y20-X1Y23 F [RN]
SLR Crossing				
GTH Quad 128 X0Y16-X0Y19 N [LS] (RCAL)	HP I/O Bank 48	HP I/O Bank 68	PCle X0Y2	GTH Quad 228 X1Y16-X1Y19 E [RS]
GTH Quad 127 X0Y12-X0Y15 M [LS]	HP I/O Bank 47	HP I/O Bank 67 E (Partial)	PCle X0Y1	GTH Quad 227 X1Y12-X1Y15 D [RS]
GTH Quad 126 X0Y8-X0Y11 L [LS]	HP I/O Bank 46	HP I/O Bank 66 D	SYSMON Configuration	GTH Quad 226 X1Y8-X1Y11 C [RS] (RCAL)
HP I/O Bank 25	HP I/O Bank 45	HR I/O Bank 65 C	Configuration	GTH Quad 225 X1Y4-X1Y7 B [RS]
HP I/O Bank 24	HP I/O Bank 44	HR I/O Bank 84/94 B	PCle X0Y0 (tandem)	GTH Quad 224 X1Y0-X1Y3 A [RS]

X16455-062117

Figure 1-28: XCKU115 Banks in FLVD1517 Package and XQKU115 in the RLD1517 Package

TIP: Bank 64 is labeled as 84/94 in some packages.

GTH Quad 133 X0Y36-X0Y39 M [L] (RCAL)	HP I/O Bank 53 O (Partial)	HP I/O Bank 73	PCle X0Y5	GTH Quad 233 X1Y36-X1Y39 I [RN]
GTH Quad 132 X0Y32-X0Y35 L [L]	HP I/O Bank 52 N	HP I/O Bank 72	PCle X0Y4	GTH Quad 232 X1Y32-X1Y35 H [RN]
GTH Quad 131 X0Y28-X0Y31 K [L]	HP I/O Bank 51 M	HP I/O Bank 71	SYSMON Configuration	GTH Quad 231 X1Y28-X1Y31 G [RN] (RCAL)
HP I/O Bank 30	HP I/O Bank 50 L	HR I/O Bank 70	Configuration	GTH Quad 230 X1Y24-X1Y27 F [RN]
HP I/O Bank 29	HP I/O Bank 49 K	HR I/O Bank 69	PCle X0Y3	GTH Quad 229 X1Y20-X1Y23
SLR Crossing				
GTH Quad 128 X0Y16-X0Y19 J [L] (RCAL)	HP I/O Bank 48 J	HP I/O Bank 68	PCle X0Y2	GTH Quad 228 X1Y16-X1Y19 E [RS]
GTH Quad 127 X0Y12-X0Y15	HP I/O Bank 47 I	HP I/O Bank 67 E	PCle X0Y1	GTH Quad 227 X1Y12-X1Y15 D [RS]
GTH Quad 126 X0Y8-X0Y11	HP I/O Bank 46 H	HP I/O Bank 66 D	SYSMON Configuration	GTH Quad 226 X1Y8-X1Y11 C [RS] (RCAL)
HP I/O Bank 25	HP I/O Bank 45 G	HR I/O Bank 65 C	Configuration	GTH Quad 225 X1Y4-X1Y7 B [RS]
HP I/O Bank 24	HP I/O Bank 44 F	HR I/O Bank 84/94 B	PCle X0Y0 (tandem)	GTH Quad 224 X1Y0-X1Y3 A [RS]

X16456-012917

Figure 1-29: XCKU115 Banks in FLVB1760 Package



TIP: Bank 64 is labeled as 84/94 in some packages.

GTH Quad 133 X0Y36-X0Y39 M [LN] (RCAL)	HP I/O Bank 53 M	HP I/O Bank 73 Q	PCle X0Y5	GTH Quad 233 X1Y36-X1Y39 G [RN]
GTH Quad 132 X0Y32-X0Y35 L [LN]	HP I/O Bank 52 L	HP I/O Bank 72 P	PCle X0Y4	GTH Quad 232 X1Y32-X1Y35 F [RN]
GTH Quad 131 X0Y28-X0Y31 K [LN]	HP I/O Bank 51 K	HP I/O Bank 71 O	SYSMON Configuration	GTH Quad 231 X1Y28-X1Y31 E [RN] (RCAL)
HP I/O Bank 30	HP I/O Bank 50 J	HR I/O Bank 70 N	Configuration	GTH Quad 230 X1Y24-X1Y27
HP I/O Bank 29	HP I/O Bank 49	HR I/O Bank 69	PCle X0Y3	GTH Quad 229 X1Y20-X1Y23
SLR Crossing				
GTH Quad 128 X0Y16-X0Y19 J [LS] (RCAL)	HP I/O Bank 48	HP I/O Bank 68	PCle X0Y2	GTH Quad 228 X1Y16-X1Y19
GTH Quad 127 X0Y12-X0Y15 I [LS]	HP I/O Bank 47 I	HP I/O Bank 67 E	PCle X0Y1	GTH Quad 227 X1Y12-X1Y15 D [RS]
GTH Quad 126 X0Y8-X0Y11 H [LS]	HP I/O Bank 46 H	HP I/O Bank 66 D	SYSMON Configuration	GTH Quad 226 X1Y8-X1Y11 C [RS] (RCAL)
HP I/O Bank 25	HP I/O Bank 45 G	HR I/O Bank 65 C	Configuration	GTH Quad 225 X1Y4-X1Y7 B [RS]
HP I/O Bank 24	HP I/O Bank 44 F	HR I/O Bank 84/94 B	PCle X0Y0 (tandem)	GTH Quad 224 X1Y0-X1Y3 A [RS]

X16457-012917

Figure 1-30: XCKU115 Banks in FLVD1924 Package



TIP: Bank 64 is labeled as 84/94 in some packages.

GTH Quad 133 X0Y36-X0Y39 P [LN] (RCAL)	HP I/O Bank 53 L	HP I/O Bank 73 P	PCIe X0Y5	GTH Quad 233 X1Y36-X1Y39 J [RN]
GTH Quad 132 X0Y32-X0Y35 O [LN]	HP I/O Bank 52 K	HP I/O Bank 72 O	PCIe X0Y4	GTH Quad 232 X1Y32-X1Y35 I [RN]
GTH Quad 131 X0Y28-X0Y31 N [LN]	HP I/O Bank 51 J	HP I/O Bank 71 N	SYSMON Configuration	GTH Quad 231 X1Y28-X1Y31 H [RN] (RCAL)
HP I/O Bank 30	HP I/O Bank 50	HR I/O Bank 70 M	Configuration	GTH Quad 230 X1Y24-X1Y27 G [RN]
HP I/O Bank 29	HP I/O Bank 49	HR I/O Bank 69	PCIe X0Y3	GTH Quad 229 X1Y20-X1Y23 F [RN]
SLR Crossing				
GTH Quad 128 X0Y16-X0Y19 M [LS] (RCAL)	HP I/O Bank 48	HP I/O Bank 68 F	PCIe X0Y2	GTH Quad 228 X1Y16-X1Y19 E [RS]
GTH Quad 127 X0Y12-X0Y15 L [LS]	HP I/O Bank 47	HP I/O Bank 67 E	PCIe X0Y1	GTH Quad 227 X1Y12-X1Y15 D [RS]
GTH Quad 126 X0Y8-X0Y11 K [LS]	HP I/O Bank 46 I	HP I/O Bank 66 D	SYSMON Configuration	GTH Quad 226 X1Y8-X1Y11 C [RS] (RCAL)
HP I/O Bank 25	HP I/O Bank 45 H	HR I/O Bank 65 C	Configuration	GTH Quad 225 X1Y4-X1Y7 B [RS]
HP I/O Bank 24	HP I/O Bank 44 G	HR I/O Bank 84/94	PCIe X0Y0 (tandem)	GTH Quad 224 X1Y0-X1Y3 A [RS]

X16458-012917

Figure 1-31: XCKU115 Banks in FLVF1924 Package and XQKU115 Banks in RLF1924 Package

GTH Quad 133 X0Y36-X0Y39 M [LN] (RCAL)	HP I/O Bank 53 M	HP I/O Bank 73 Q	PCle X0Y5	GTH Quad 233 X1Y36-X1Y39 G [RN]
GTH Quad 132 X0Y32-X0Y35 L [LN]	HP I/O Bank 52 L	HP I/O Bank 72 P	PCle X0Y4	GTH Quad 232 X1Y32-X1Y35 F [RN]
GTH Quad 131 X0Y28-X0Y31 K [LN]	HP I/O Bank 51 K	HP I/O Bank 71 O	SYSMON Configuration	GTH Quad 231 X1Y28-X1Y31 E [RN] (RCAL)
HP I/O Bank 30	HP I/O Bank 50 J	HR I/O Bank 70 N	Configuration	GTH Quad 230 X1Y24-X1Y27
HP I/O Bank 29	HP I/O Bank 49	HR I/O Bank 69	PCle X0Y3	GTH Quad 229 X1Y20-X1Y23
SLR Crossing				
GTH Quad 128 X0Y16-X0Y19 J [LS] (RCAL)	HP I/O Bank 48	HP I/O Bank 68	PCle X0Y2	GTH Quad 228 X1Y16-X1Y19
GTH Quad 127 X0Y12-X0Y15 I [LS]	HP I/O Bank 47 I	HP I/O Bank 67 E	PCle X0Y1	GTH Quad 227 X1Y12-X1Y15 D [RS]
GTH Quad 126 X0Y8-X0Y11 H [LS]	HP I/O Bank 46 H	HP I/O Bank 66 D	SYSMON Configuration	GTH Quad 226 X1Y8-X1Y11 C [RS] (RCAL)
HP I/O Bank 25	HP I/O Bank 45 G	HR I/O Bank 65 C	Configuration	GTH Quad 225 X1Y4-X1Y7 B [RS]
HP I/O Bank 24	HP I/O Bank 44 F	HR I/O Bank 84/94 B	PCle X0Y0 (tandem)	GTH Quad 224 X1Y0-X1Y3 A [RS]

X16459-062117

Figure 1-32: XCKU115 Banks in FLVA2104 Package



TIP: Bank 64 is labeled as 84/94 in some packages.

GTH Quad 133 X0Y36-X0Y39 R [LN] (RCAL)	HP I/O Bank 53 L	HP I/O Bank 73 O	PCle X0Y5	GTH Quad 233 X1Y36-X1Y39 J [RN]
GTH Quad 132 X0Y32-X0Y35 Q [LN]	HP I/O Bank 52 K	HP I/O Bank 72 N	PCle X0Y4	GTH Quad 232 X1Y32-X1Y35 I [RN]
GTH Quad 131 X0Y28-X0Y31 P [LN]	HP I/O Bank 51 J	HP I/O Bank 71 M	SYSMON Configuration	GTH Quad 231 X1Y28-X1Y31 H [RN] (RCAL)
HP I/O Bank 30	HP I/O Bank 50	HR I/O Bank 70	Configuration	GTH Quad 230 X1Y24-X1Y27 G [RN]
HP I/O Bank 29	HP I/O Bank 49	HR I/O Bank 69	PCle X0Y3	GTH Quad 229 X1Y20-X1Y23 F [RN]
SLR Crossing				
GTH Quad 128 X0Y16-X0Y19 M [LS] (RCAL)	HP I/O Bank 48	HP I/O Bank 68 F (Partial)	PCle X0Y2	GTH Quad 228 X1Y16-X1Y19 E [RS]
GTH Quad 127 X0Y12-X0Y15 L [LS]	HP I/O Bank 47	HP I/O Bank 67 E	PCle X0Y1	GTH Quad 227 X1Y12-X1Y15 D [RS]
GTH Quad 126 X0Y8-X0Y11 K [LS]	HP I/O Bank 46 I	HP I/O Bank 66 D	SYSMON Configuration	GTH Quad 226 X1Y8-X1Y11 C [RS] (RCAL)
HP I/O Bank 25	HP I/O Bank 45 H	HR I/O Bank 65 C	Configuration	GTH Quad 225 X1Y4-X1Y7 B [RS]
HP I/O Bank 24	HP I/O Bank 44 G	HR I/O Bank 84/94 B	PCle X0Y0 (tandem)	GTH Quad 224 X1Y0-X1Y3 A [RS]

X16460-012917

Figure 1-33: XCKU115 Banks in FLVB2104 Package



TIP: Bank 64 is labeled as 84/94 in some packages.

XCVU065 Bank Diagrams

GTY Quad 128 X0Y16-X0Y19	CMAC X0Y2	HP I/O Bank 48	HP I/O Bank 68	PCIe X0Y1	GTH Quad 228 X0Y16-X0Y19
GTY Quad 127 X0Y12-X0Y15	CMAC X0Y1	HP I/O Bank 47	HP I/O Bank 67	ILKN X1Y2	GTH Quad 227 X0Y12-X0Y15
GTY Quad 126 X0Y8-X0Y11	ILKN X0Y1	HP I/O Bank 46	HP I/O Bank 66	SYSMON Configuration	GTH Quad 226 X0Y8-X0Y11 (RCAL)
GTY Quad 125 X0Y4-X0Y7 (RCAL)	CMAC X0Y0	HP I/O Bank 45	HP I/O Bank 65	Configuration	GTH Quad 225 X0Y4-X0Y7
GTY Quad 124 X0Y0-X0Y3	ILKN X0Y0	HP I/O Bank 44	HR I/O Bank 84/94	PCIe X0Y0 (tandem)	GTH Quad 224 X0Y0-X0Y3

X16466-012917

Figure 1-34: XCVU065 Banks

GTY Quad 128 X0Y16-X0Y19 J [L]	CMAC X0Y2	HP I/O Bank 48 K	HP I/O Bank 68 F	PCIe X0Y1	GTH Quad 228 X0Y16-X0Y19 E [R]
GTY Quad 127 X0Y12-X0Y15 I [L]	CMAC X0Y1	HP I/O Bank 47 J	HP I/O Bank 67 E	ILKN X1Y2	GTH Quad 227 X0Y12-X0Y15 D [R]
GTY Quad 126 X0Y8-X0Y11 H [L]	ILKN X0Y1	HP I/O Bank 46 I	HP I/O Bank 66 D	SYSMON Configuration	GTH Quad 226 X0Y8-X0Y11 C [R] (RCAL)
GTY Quad 125 X0Y4-X0Y7 G [L] (RCAL)	CMAC X0Y0	HP I/O Bank 45 H	HP I/O Bank 65 C	Configuration	GTH Quad 225 X0Y4-X0Y7 B [R]
GTY Quad 124 X0Y0-X0Y3 F [L]	ILKN X0Y0	HP I/O Bank 44 G	HR I/O Bank 84/94 B	PCIe X0Y0 (tandem)	GTH Quad 224 X0Y0-X0Y3 A [R]

X16467-062117

Figure 1-35: XCVU065 Banks in FFVC1517 Package

XCVU080 Bank Diagrams

GTU Quad 131 X0Y28-X0Y31	CMAC X0Y3	HP I/O Bank 51	HP I/O Bank 71	PCIe X0Y3	GTH Quad 231 X0Y28-X0Y31
GTU Quad 130 X0Y24-X0Y27	ILKN X0Y4	HP I/O Bank 50	HP I/O Bank 70	ILKN X1Y4	GTH Quad 230 X0Y24-X0Y27
GTU Quad 129 X0Y20-X0Y23 (RCAL)	CMAC X0Y2	HP I/O Bank 49	HP I/O Bank 69	PCIe X0Y2	GTH Quad 229 X0Y20-X0Y23
GTU Quad 128 X0Y16-X0Y19	ILKN X0Y3	HP I/O Bank 48	HP I/O Bank 68	PCIe X0Y1	GTH Quad 228 X0Y16-X0Y19
GTU Quad 127 X0Y12-X0Y15	CMAC X0Y1	HP I/O Bank 47	HP I/O Bank 67	ILKN X1Y2	GTH Quad 227 X0Y12-X0Y15
GTU Quad 126 X0Y8-X0Y11	ILKN X0Y1	HP I/O Bank 46	HP I/O Bank 66	SYSMON Configuration	GTH Quad 226 X0Y8-X0Y11
GTU Quad 125 X0Y4-X0Y7	CMAC X0Y0	HP I/O Bank 45	HP I/O Bank 65	Configuration	GTH Quad 225 X0Y4-X0Y7 (RCAL)
GTU Quad 124 X0Y0-X0Y3	ILKN X0Y0	HP I/O Bank 44	HR I/O Bank 84/94	PCIe X0Y0 (tandem)	GTH Quad 224 X0Y0-X0Y3

X16468-062117

Figure 1-36: XCVU080 Banks

GTY Quad 131 X0Y28-X0Y31	CMAC X0Y3	HP I/O Bank 51	HP I/O Bank 71	PCle X0Y3	GTH Quad 231 X0Y28-X0Y31
GTY Quad 130 X0Y24-X0Y27	ILKN X0Y4	HP I/O Bank 50	HP I/O Bank 70	ILKN X1Y4	GTH Quad 230 X0Y24-X0Y27
GTY Quad 129 X0Y20-X0Y23 J [L] (RCAL)	CMAC X0Y2	HP I/O Bank 49	HP I/O Bank 69	PCle X0Y2	GTH Quad 229 X0Y20-X0Y23
GTY Quad 128 X0Y16-X0Y19 I [L]	ILKN X0Y3	HP I/O Bank 48 K	HP I/O Bank 68 F	PCle X0Y1	GTH Quad 228 X0Y16-X0Y19 E [R]
GTY Quad 127 X0Y12-X0Y15 H [L]	CMAC X0Y1	HP I/O Bank 47 J	HP I/O Bank 67 E	ILKN X1Y2	GTH Quad 227 X0Y12-X0Y15 D [R]
GTY Quad 126 X0Y8-X0Y11 G [L]	ILKN X0Y1	HP I/O Bank 46 I	HP I/O Bank 66 D	SYSMON Configuration	GTH Quad 226 X0Y8-X0Y11 C [R]
GTY Quad 125 X0Y4-X0Y7 F [L]	CMAC X0Y0	HP I/O Bank 45 H	HP I/O Bank 65 C	Configuration	GTH Quad 225 X0Y4-X0Y7 B [R] (RCAL)
GTY Quad 124 X0Y0-X0Y3	ILKN X0Y0	HP I/O Bank 44 G	HR I/O Bank 84/94 B	PCle X0Y0 (tandem)	GTH Quad 224 X0Y0-X0Y3 A [R]

X16469-062117

Figure 1-37: XCVU080 Banks in FFVC1517 Package

GTY Quad 131 X0Y28-X0Y31 R [LN]	CMAC X0Y3	HP I/O Bank 51	HP I/O Bank 71 H	PCle X0Y3	GTH Quad 231 X0Y28-X0Y31 H [RN]
GTY Quad 130 X0Y24-X0Y27 Q [LN]	ILKN X0Y4	HP I/O Bank 50	HP I/O Bank 70 G	ILKN X1Y4	GTH Quad 230 X0Y24-X0Y27 G [RN]
GTY Quad 129 X0Y20-X0Y23 P [LN] (RCAL)	CMAC X0Y2	HP I/O Bank 49	HP I/O Bank 69 F	PCle X0Y2	GTH Quad 229 X0Y20-X0Y23 F [RN]
GTY Quad 128 X0Y16-X0Y19 O [LN]	ILKN X0Y3	HP I/O Bank 48	HP I/O Bank 68	PCle X0Y1	GTH Quad 228 X0Y16-X0Y19 E [RS]
GTY Quad 127 X0Y12-X0Y15 N [LS]	CMAC X0Y1	HP I/O Bank 47	HP I/O Bank 67 E (Partial)	ILKN X1Y2	GTH Quad 227 X0Y12-X0Y15 D [RS]
GTY Quad 126 X0Y8-X0Y11 M [LS]	ILKN X0Y1	HP I/O Bank 46	HP I/O Bank 66 D	SYSMON Configuration	GTH Quad 226 X0Y8-X0Y11 C [RS]
GTY Quad 125 X0Y4-X0Y7 L [LS]	CMAC X0Y0	HP I/O Bank 45	HP I/O Bank 65 C	Configuration	GTH Quad 225 X0Y4-X0Y7 B [RS] (RCAL)
GTY Quad 124 X0Y0-X0Y3 K [LS]	ILKN X0Y0	HP I/O Bank 44	HR I/O Bank 84/94 B	PCle X0Y0 (tandem)	GTH Quad 224 X0Y0-X0Y3 A [RS]

X16470-062117

Figure 1-38: XCVU080 Banks in FFVD1517 Package

GTY Quad 131 X0Y28-X0Y31 M [L]	CMAC X0Y3	HP I/O Bank 51 O (Partial)	HP I/O Bank 71 L	PCIe X0Y3	GTH Quad 231 X0Y28-X0Y31 H [RN]
GTY Quad 130 X0Y24-X0Y27 L [L]	ILKN X0Y4	HP I/O Bank 50 N	HP I/O Bank 70 K	ILKN X1Y4	GTH Quad 230 X0Y24-X0Y27 G [RN]
GTY Quad 129 X0Y20-X0Y23 K [L] (RCAL)	CMAC X0Y2	HP I/O Bank 49 M	HP I/O Bank 69	PCIe X0Y2	GTH Quad 229 X0Y20-X0Y23 F [RN]
GTY Quad 128 X0Y16-X0Y19 J [L]	ILKN X0Y3	HP I/O Bank 48 J	HP I/O Bank 68	PCIe X0Y1	GTH Quad 228 X0Y16-X0Y19 E [RS]
GTY Quad 127 X0Y12-X0Y15	CMAC X0Y1	HP I/O Bank 47 I	HP I/O Bank 67 E	ILKN X1Y2	GTH Quad 227 X0Y12-X0Y15 D [RS]
GTY Quad 126 X0Y8-X0Y11	ILKN X0Y1	HP I/O Bank 46 H	HP I/O Bank 66 D	SYSMON Configuration	GTH Quad 226 X0Y8-X0Y11 C [RS]
GTY Quad 125 X0Y4-X0Y7	CMAC X0Y0	HP I/O Bank 45 G	HP I/O Bank 65 C	Configuration	GTH Quad 225 X0Y4-X0Y7 B [RS] (RCAL)
GTY Quad 124 X0Y0-X0Y3	ILKN X0Y0	HP I/O Bank 44 F	HR I/O Bank 84/94 B	PCIe X0Y0 (tandem)	GTH Quad 224 X0Y0-X0Y3 A [RS]

X16471-062117

Figure 1-39: XCVU080 Banks in FFVB1760 Package

GTU Quad 131 X0Y28-X0Y31	CMAC X0Y3	HP I/O Bank 51 M	HP I/O Bank 71 Q	PCIe X0Y3	GTH Quad 231 X0Y28-X0Y31
GTU Quad 130 X0Y24-X0Y27 M [LN]	ILKN X0Y4	HP I/O Bank 50 L	HP I/O Bank 70 P	ILKN X1Y4	GTH Quad 230 X0Y24-X0Y27 G [RN]
GTU Quad 129 X0Y20-X0Y23 L [LN] (RCAL)	CMAC X0Y2	HP I/O Bank 49 K	HP I/O Bank 69 O	PCIe X0Y2	GTH Quad 229 X0Y20-X0Y23 F [RN]
GTU Quad 128 X0Y16-X0Y19 K [LN]	ILKN X0Y3	HP I/O Bank 48 J	HP I/O Bank 68 N	PCIe X0Y1	GTH Quad 228 X0Y16-X0Y19 E [RN]
GTU Quad 127 X0Y12-X0Y15 J [LS]	CMAC X0Y1	HP I/O Bank 47 I	HP I/O Bank 67 E	ILKN X1Y2	GTH Quad 227 X0Y12-X0Y15 D [RS]
GTU Quad 126 X0Y8-X0Y11 I [LS]	ILKN X0Y1	HP I/O Bank 46 H	HP I/O Bank 66 D	SYSMON Configuration	GTH Quad 226 X0Y8-X0Y11 C [RS]
GTU Quad 125 X0Y4-X0Y7 H [LS]	CMAC X0Y0	HP I/O Bank 45 G	HP I/O Bank 65 C	Configuration	GTH Quad 225 X0Y4-X0Y7 B [RS] (RCAL)
GTU Quad 124 X0Y0-X0Y3	ILKN X0Y0	HP I/O Bank 44 F	HR I/O Bank 84/94 B	PCIe X0Y0 (tandem)	GTH Quad 224 X0Y0-X0Y3 A [RS]

X16472-062117

Figure 1-40: XCVU080 Banks in FFVA2104 Package

GTY Quad 131 X0Y28-X0Y31 R [LN]	CMAC X0Y3	HP I/O Bank 51 L	HP I/O Bank 71 O	PCIe X0Y3	GTH Quad 231 X0Y28-X0Y31 H [RN]
GTY Quad 130 X0Y24-X0Y27 Q [LN]	ILKN X0Y4	HP I/O Bank 50 K	HP I/O Bank 70 N	ILKN X1Y4	GTH Quad 230 X0Y24-X0Y27 G [RN]
GTY Quad 129 X0Y20-X0Y23 P [LN] (RCAL)	CMAC X0Y2	HP I/O Bank 49 J	HP I/O Bank 69 M	PCIe X0Y2	GTH Quad 229 X0Y20-X0Y23 F [RN]
GTY Quad 128 X0Y16-X0Y19 O [LN]	ILKN X0Y3	HP I/O Bank 48	HP I/O Bank 68 F (Partial)	PCIe X0Y1	GTH Quad 228 X0Y16-X0Y19 E [RS]
GTY Quad 127 X0Y12-X0Y15 N [LS]	CMAC X0Y1	HP I/O Bank 47	HP I/O Bank 67 E	ILKN X1Y2	GTH Quad 227 X0Y12-X0Y15 D [RS]
GTY Quad 126 X0Y8-X0Y11 M [LS]	ILKN X0Y1	HP I/O Bank 46 I	HP I/O Bank 66 D	SYSMON Configuration	GTH Quad 226 X0Y8-X0Y11 C [RS]
GTY Quad 125 X0Y4-X0Y7 L [LS]	CMAC X0Y0	HP I/O Bank 45 H	HP I/O Bank 65 C	Configuration	GTH Quad 225 X0Y4-X0Y7 B [RS] (RCAL)
GTY Quad 124 X0Y0-X0Y3 K [LS]	ILKN X0Y0	HP I/O Bank 44 G	HR I/O Bank 84/94 B	PCIe X0Y0 (tandem)	GTH Quad 224 X0Y0-X0Y3 A [RS]

X16473-062117

Figure 1-41: XCVU080 Banks in FFVB2104 Package

XCVU095 Bank Diagrams

GTY Quad 131 X0Y28-X0Y31	CMAC X0Y3	HP I/O Bank 51	HP I/O Bank 71	PCIe X0Y3	GTH Quad 231 X0Y28-X0Y31
GTY Quad 130 X0Y24-X0Y27	ILKN X0Y4	HP I/O Bank 50	HP I/O Bank 70	ILKN X1Y4	GTH Quad 230 X0Y24-X0Y27
GTY Quad 129 X0Y20-X0Y23 (RCAL)	CMAC X0Y2	HP I/O Bank 49	HP I/O Bank 69	PCIe X0Y2	GTH Quad 229 X0Y20-X0Y23
GTY Quad 128 X0Y16-X0Y19	ILKN X0Y3	HP I/O Bank 48	HP I/O Bank 68	PCIe X0Y1	GTH Quad 228 X0Y16-X0Y19
GTY Quad 127 X0Y12-X0Y15	CMAC X0Y1	HP I/O Bank 47	HP I/O Bank 67	ILKN X1Y2	GTH Quad 227 X0Y12-X0Y15
GTY Quad 126 X0Y8-X0Y11	ILKN X0Y1	HP I/O Bank 46	HP I/O Bank 66	SYSMON Configuration	GTH Quad 226 X0Y8-X0Y11
GTY Quad 125 X0Y4-X0Y7	CMAC X0Y0	HP I/O Bank 45	HP I/O Bank 65	Configuration	GTH Quad 225 X0Y4-X0Y7 (RCAL)
GTY Quad 124 X0Y0-X0Y3	ILKN X0Y0	HP I/O Bank 44	HR I/O Bank 84/94	PCIe X0Y0 (tandem)	GTH Quad 224 X0Y0-X0Y3

X16474-062117

Figure 1-42: XCVU095 Banks

GTY Quad 131 X0Y28-X0Y31	CMAC X0Y3	HP I/O Bank 51	HP I/O Bank 71	PCIe X0Y3	GTH Quad 231 X0Y28-X0Y31
GTY Quad 130 X0Y24-X0Y27	ILKN X0Y4	HP I/O Bank 50	HP I/O Bank 70	ILKN X1Y4	GTH Quad 230 X0Y24-X0Y27
GTY Quad 129 X0Y20-X0Y23 J [L] (RCAL)	CMAC X0Y2	HP I/O Bank 49	HP I/O Bank 69	PCIe X0Y2	GTH Quad 229 X0Y20-X0Y23
GTY Quad 128 X0Y16-X0Y19 I [L]	ILKN X0Y3	HP I/O Bank 48 K	HP I/O Bank 68 F	PCIe X0Y1	GTH Quad 228 X0Y16-X0Y19 E [R]
GTY Quad 127 X0Y12-X0Y15 H [L]	CMAC X0Y1	HP I/O Bank 47 J	HP I/O Bank 67 E	ILKN X1Y2	GTH Quad 227 X0Y12-X0Y15 D [R]
GTY Quad 126 X0Y8-X0Y11 G [L]	ILKN X0Y1	HP I/O Bank 46 I	HP I/O Bank 66 D	SYSMON Configuration	GTH Quad 226 X0Y8-X0Y11 C [R]
GTY Quad 125 X0Y4-X0Y7 F [L]	CMAC X0Y0	HP I/O Bank 45 H	HP I/O Bank 65 C	Configuration	GTH Quad 225 X0Y4-X0Y7 B [R] (RCAL)
GTY Quad 124 X0Y0-X0Y3	ILKN X0Y0	HP I/O Bank 44 G	HR I/O Bank 84/94 B	PCIe X0Y0 (tandem)	GTH Quad 224 X0Y0-X0Y3 A [R]

X16475-062117

Figure 1-43: XCVU095 Banks in FFVC1517 Package

GTU Quad 131 X0Y28-X0Y31 R [LN]	CMAC X0Y3	HP I/O Bank 51	HP I/O Bank 71 H	PCle X0Y3	GTH Quad 231 X0Y28-X0Y31 H [RN]
GTU Quad 130 X0Y24-X0Y27 Q [LN]	ILKN X0Y4	HP I/O Bank 50	HP I/O Bank 70 G	ILKN X1Y4	GTH Quad 230 X0Y24-X0Y27 G [RN]
GTU Quad 129 X0Y20-X0Y23 P [LN] (RCAL)	CMAC X0Y2	HP I/O Bank 49	HP I/O Bank 69 F	PCle X0Y2	GTH Quad 229 X0Y20-X0Y23 F [RN]
GTU Quad 128 X0Y16-X0Y19 O [LN]	ILKN X0Y3	HP I/O Bank 48	HP I/O Bank 68	PCle X0Y1	GTH Quad 228 X0Y16-X0Y19 E [RS]
GTU Quad 127 X0Y12-X0Y15 N [LS]	CMAC X0Y1	HP I/O Bank 47	HP I/O Bank 67 E (Partial)	ILKN X1Y2	GTH Quad 227 X0Y12-X0Y15 D [RS]
GTU Quad 126 X0Y8-X0Y11 M [LS]	ILKN X0Y1	HP I/O Bank 46	HP I/O Bank 66 D	SYSMON Configuration	GTH Quad 226 X0Y8-X0Y11 C [RS]
GTU Quad 125 X0Y4-X0Y7 L [LS]	CMAC X0Y0	HP I/O Bank 45	HP I/O Bank 65 C	Configuration	GTH Quad 225 X0Y4-X0Y7 B [RS] (RCAL)
GTU Quad 124 X0Y0-X0Y3 K [LS]	ILKN X0Y0	HP I/O Bank 44	HR I/O Bank 84/94 B	PCle X0Y0 (tandem)	GTH Quad 224 X0Y0-X0Y3 A [RS]

X16476-062117

Figure 1-44: XCVU095 Banks in FFVD1517 Package

GTU Quad 131 X0Y28-X0Y31 M [L]	CMAC X0Y3	HP I/O Bank 51 O (Partial)	HP I/O Bank 71 L	PCIe X0Y3	GTH Quad 231 X0Y28-X0Y31 H [RN]
GTU Quad 130 X0Y24-X0Y27 L [L]	ILKN X0Y4	HP I/O Bank 50 N	HP I/O Bank 70 K	ILKN X1Y4	GTH Quad 230 X0Y24-X0Y27 G [RN]
GTU Quad 129 X0Y20-X0Y23 K [L] (RCAL)	CMAC X0Y2	HP I/O Bank 49 M	HP I/O Bank 69	PCIe X0Y2	GTH Quad 229 X0Y20-X0Y23 F [RN]
GTU Quad 128 X0Y16-X0Y19 J [L]	ILKN X0Y3	HP I/O Bank 48 J	HP I/O Bank 68	PCIe X0Y1	GTH Quad 228 X0Y16-X0Y19 E [RS]
GTU Quad 127 X0Y12-X0Y15	CMAC X0Y1	HP I/O Bank 47 I	HP I/O Bank 67 E	ILKN X1Y2	GTH Quad 227 X0Y12-X0Y15 D [RS]
GTU Quad 126 X0Y8-X0Y11	ILKN X0Y1	HP I/O Bank 46 H	HP I/O Bank 66 D	SYSMON Configuration	GTH Quad 226 X0Y8-X0Y11 C [RS]
GTU Quad 125 X0Y4-X0Y7	CMAC X0Y0	HP I/O Bank 45 G	HP I/O Bank 65 C	Configuration	GTH Quad 225 X0Y4-X0Y7 B [RS] (RCAL)
GTU Quad 124 X0Y0-X0Y3	ILKN X0Y0	HP I/O Bank 44 F	HR I/O Bank 84/94 B	PCIe X0Y0 (tandem)	GTH Quad 224 X0Y0-X0Y3 A [RS]

X16477-062117

Figure 1-45: XCVU095 Banks in FFVB1760 Package

GTY Quad 131 X0Y28-X0Y31	CMAC X0Y3	HP I/O Bank 51 M	HP I/O Bank 71 Q	PCle X0Y3	GTH Quad 231 X0Y28-X0Y31
GTY Quad 130 X0Y24-X0Y27 M [LN]	ILKN X0Y4	HP I/O Bank 50 L	HP I/O Bank 70 P	ILKN X1Y4	GTH Quad 230 X0Y24-X0Y27 G [RN]
GTY Quad 129 X0Y20-X0Y23 L [LN] (RCAL)	CMAC X0Y2	HP I/O Bank 49 K	HP I/O Bank 69 O	PCle X0Y2	GTH Quad 229 X0Y20-X0Y23 F [RN]
GTY Quad 128 X0Y16-X0Y19 K [LN]	ILKN X0Y3	HP I/O Bank 48 J	HP I/O Bank 68 N	PCle X0Y1	GTH Quad 228 X0Y16-X0Y19 E [RN]
GTY Quad 127 X0Y12-X0Y15 J [LS]	CMAC X0Y1	HP I/O Bank 47 I	HP I/O Bank 67 E	ILKN X1Y2	GTH Quad 227 X0Y12-X0Y15 D [RS]
GTY Quad 126 X0Y8-X0Y11 I [LS]	ILKN X0Y1	HP I/O Bank 46 H	HP I/O Bank 66 D	SYSMON Configuration	GTH Quad 226 X0Y8-X0Y11 C [RS]
GTY Quad 125 X0Y4-X0Y7 H [LS]	CMAC X0Y0	HP I/O Bank 45 G	HP I/O Bank 65 C	Configuration	GTH Quad 225 X0Y4-X0Y7 B [RS] (RCAL)
GTY Quad 124 X0Y0-X0Y3	ILKN X0Y0	HP I/O Bank 44 F	HR I/O Bank 84/94 B	PCle X0Y0 (tandem)	GTH Quad 224 X0Y0-X0Y3 A [RS]

X16478-062117

Figure 1-46: XCVU095 Banks in FFVA2104 Package

GTU Quad 131 X0Y28-X0Y31 R [LN]	CMAC X0Y3	HP I/O Bank 51 L	HP I/O Bank 71 O	PCle X0Y3	GTH Quad 231 X0Y28-X0Y31 H [RN]
GTU Quad 130 X0Y24-X0Y27 Q [LN]	ILKN X0Y4	HP I/O Bank 50 K	HP I/O Bank 70 N	ILKN X1Y4	GTH Quad 230 X0Y24-X0Y27 G [RN]
GTU Quad 129 X0Y20-X0Y23 P [LN] (RCAL)	CMAC X0Y2	HP I/O Bank 49 J	HP I/O Bank 69 M	PCle X0Y2	GTH Quad 229 X0Y20-X0Y23 F [RN]
GTU Quad 128 X0Y16-X0Y19 O [LN]	ILKN X0Y3	HP I/O Bank 48	HP I/O Bank 68 F (Partial)	PCle X0Y1	GTH Quad 228 X0Y16-X0Y19 E [RS]
GTU Quad 127 X0Y12-X0Y15 N [LS]	CMAC X0Y1	HP I/O Bank 47	HP I/O Bank 67 E	ILKN X1Y2	GTH Quad 227 X0Y12-X0Y15 D [RS]
GTU Quad 126 X0Y8-X0Y11 M [LS]	ILKN X0Y1	HP I/O Bank 46 I	HP I/O Bank 66 D	SYSMON Configuration	GTH Quad 226 X0Y8-X0Y11 C [RS]
GTU Quad 125 X0Y4-X0Y7 L [LS]	CMAC X0Y0	HP I/O Bank 45 H	HP I/O Bank 65 C	Configuration	GTH Quad 225 X0Y4-X0Y7 B [RS] (RCAL)
GTU Quad 124 X0Y0-X0Y3 K [LS]	ILKN X0Y0	HP I/O Bank 44 G	HR I/O Bank 84/94 B	PCle X0Y0 (tandem)	GTH Quad 224 X0Y0-X0Y3 A [RS]

X16479-062117

Figure 1-47: XCVU095 Banks in FFVB2104 Package

GTU Quad 131 X0Y28-X0Y31 U [LN]	CMAC X0Y3	HP I/O Bank 51	HP I/O Bank 71 I	PCIe X0Y3	GTH Quad 231 X0Y28-X0Y31 H [RN]
GTU Quad 130 X0Y24-X0Y27 T [LN]	ILKN X0Y4	HP I/O Bank 50	HP I/O Bank 70 H	ILKN X1Y4	GTH Quad 230 X0Y24-X0Y27 G [RN]
GTU Quad 129 X0Y20-X0Y23 S [LN] (RCAL)	CMAC X0Y2	HP I/O Bank 49	HP I/O Bank 69 G	PCIe X0Y2	GTH Quad 229 X0Y20-X0Y23 F [RN]
GTU Quad 128 X0Y16-X0Y19 R [LC]	ILKN X0Y3	HP I/O Bank 48	HP I/O Bank 68 F	PCIe X0Y1	GTH Quad 228 X0Y16-X0Y19 E [RC]
GTU Quad 127 X0Y12-X0Y15 Q [LC]	CMAC X0Y1	HP I/O Bank 47	HP I/O Bank 67 E	ILKN X1Y2	GTH Quad 227 X0Y12-X0Y15 D [RC]
GTU Quad 126 X0Y8-X0Y11 P [LC]	ILKN X0Y1	HP I/O Bank 46	HP I/O Bank 66 D	SYSMON Configuration	GTH Quad 226 X0Y8-X0Y11 C [RC]
GTU Quad 125 X0Y4-X0Y7 O [LC]	CMAC X0Y0	HP I/O Bank 45	HP I/O Bank 65 C	Configuration	GTH Quad 225 X0Y4-X0Y7 B [RC] (RCAL)
GTU Quad 124 X0Y0-X0Y3 N [LC]	ILKN X0Y0	HP I/O Bank 44	HR I/O Bank 84/94 B	PCIe X0Y0 (tandem)	GTH Quad 224 X0Y0-X0Y3 A [RC]

X16480-062117

Figure 1-48: XCVU095 Banks in FFVC2104 Package

XCVU125 Bank Diagrams

GTU Quad 133 X0Y36-X0Y39	CMAC X0Y5	HP I/O Bank 53	HP I/O Bank 73	PCIe X0Y3	GTH Quad 233 X0Y36-X0Y39
GTU Quad 132 X0Y32-X0Y35	CMAC X0Y4	HP I/O Bank 52	HP I/O Bank 72	ILKN X1Y5	GTH Quad 232 X0Y32-X0Y35
GTU Quad 131 X0Y28-X0Y31	ILKN X0Y4	HP I/O Bank 51	HP I/O Bank 71	SYSMON Configuration	GTH Quad 231 X0Y28-X0Y31 (RCAL)
GTU Quad 130 X0Y24-X0Y27 (RCAL)	CMAC X0Y3	HP I/O Bank 50	HP I/O Bank 70	Configuration	GTH Quad 230 X0Y24-X0Y27
GTU Quad 129 X0Y20-X0Y23	ILKN X0Y3	HP I/O Bank 49	HR I/O Bank 69	PCIe X0Y2	GTH Quad 229 X0Y20-X0Y23
SLR Crossing					
GTU Quad 128 X0Y16-X0Y19	CMAC X0Y2	HP I/O Bank 48	HP I/O Bank 68	PCIe X0Y1	GTH Quad 228 X0Y16-X0Y19
GTU Quad 127 X0Y12-X0Y15	CMAC X0Y1	HP I/O Bank 47	HP I/O Bank 67	ILKN X1Y2	GTH Quad 227 X0Y12-X0Y15
GTU Quad 126 X0Y8-X0Y11	ILKN X0Y1	HP I/O Bank 46	HP I/O Bank 66	SYSMON Configuration	GTH Quad 226 X0Y8-X0Y11 (RCAL)
GTU Quad 125 X0Y4-X0Y7 (RCAL)	CMAC X0Y0	HP I/O Bank 45	HP I/O Bank 65	Configuration	GTH Quad 225 X0Y4-X0Y7
GTU Quad 124 X0Y0-X0Y3	ILKN X0Y0	HP I/O Bank 44	HR I/O Bank 84/94	PCIe X0Y0 (tandem)	GTH Quad 224 X0Y0-X0Y3

X16481-012917

Figure 1-49: XCVU125 Banks

GTY Quad 133 X0Y36-X0Y39	CMAC X0Y5	HP I/O Bank 53	HP I/O Bank 73 H	PCIe X0Y3	GTH Quad 233 X0Y36-X0Y39 J [RN]
GTY Quad 132 X0Y32-X0Y35 R [LN]	CMAC X0Y4	HP I/O Bank 52	HP I/O Bank 72 G	ILKN X1Y5	GTH Quad 232 X0Y32-X0Y35 I [RN]
GTY Quad 131 X0Y28-X0Y31 Q [LN]	ILKN X0Y4	HP I/O Bank 51	HP I/O Bank 71 F	SYSMON Configuration	GTH Quad 231 X0Y28-X0Y31 H [RN] (RCAL)
GTY Quad 130 X0Y24-X0Y27 P [LN] (RCAL)	CMAC X0Y3	HP I/O Bank 50	HP I/O Bank 70	Configuration	GTH Quad 230 X0Y24-X0Y27 G [RN]
GTY Quad 129 X0Y20-X0Y23 O [LN]	ILKN X0Y3	HP I/O Bank 49	HR I/O Bank 69	PCIe X0Y2	GTH Quad 229 X0Y20-X0Y23 F [RN]
SLR Crossing					
GTY Quad 128 X0Y16-X0Y19	CMAC X0Y2	HP I/O Bank 48	HP I/O Bank 68	PCIe X0Y1	GTH Quad 228 X0Y16-X0Y19 E [RS]
GTY Quad 127 X0Y12-X0Y15 N [LS]	CMAC X0Y1	HP I/O Bank 47	HP I/O Bank 67 E (Partial)	ILKN X1Y2	GTH Quad 227 X0Y12-X0Y15 D [RS]
GTY Quad 126 X0Y8-X0Y11 M [LS]	ILKN X0Y1	HP I/O Bank 46	HP I/O Bank 66 D	SYSMON Configuration	GTH Quad 226 X0Y8-X0Y11 C [RS] (RCAL)
GTY Quad 125 X0Y4-X0Y7 L [LS] (RCAL)	CMAC X0Y0	HP I/O Bank 45	HP I/O Bank 65 C	Configuration	GTH Quad 225 X0Y4-X0Y7 B [RS]
GTY Quad 124 X0Y0-X0Y3 K [LS]	ILKN X0Y0	HP I/O Bank 44	HR I/O Bank 84/94 B	PCIe X0Y0 (tandem)	GTH Quad 224 X0Y0-X0Y3 A [RS]

X16482-012917

Figure 1-50: XCVU125 Banks in FLVD1517 Package

GTU Quad 133 X0Y36-X0Y39	CMAC X0Y5	HP I/O Bank 53 O (Partial)	HP I/O Bank 73	PCIe X0Y3	GTH Quad 233 X0Y36-X0Y39 I [RN]
GTU Quad 132 X0Y32-X0Y35 M [L]	CMAC X0Y4	HP I/O Bank 52 N	HP I/O Bank 72	ILKN X1Y5	GTH Quad 232 X0Y32-X0Y35 H [RN]
GTU Quad 131 X0Y28-X0Y31 L [L]	ILKN X0Y4	HP I/O Bank 51 M	HP I/O Bank 71	SYSMON Configuration	GTH Quad 231 X0Y28-X0Y31 G [RN] (RCAL)
GTU Quad 130 X0Y24-X0Y27 K [L] (RCAL)	CMAC X0Y3	HP I/O Bank 50 L	HP I/O Bank 70	Configuration	GTH Quad 230 X0Y24-X0Y27 F [RN]
GTU Quad 129 X0Y20-X0Y23 J [L]	ILKN X0Y3	HP I/O Bank 49 K	HR I/O Bank 69	PCIe X0Y2	GTH Quad 229 X0Y20-X0Y23
SLR Crossing					
GTU Quad 128 X0Y16-X0Y19	CMAC X0Y2	HP I/O Bank 48 J	HP I/O Bank 68	PCIe X0Y1	GTH Quad 228 X0Y16-X0Y19 E [RS]
GTU Quad 127 X0Y12-X0Y15	CMAC X0Y1	HP I/O Bank 47 I	HP I/O Bank 67 E	ILKN X1Y2	GTH Quad 227 X0Y12-X0Y15 D [RS]
GTU Quad 126 X0Y8-X0Y11	ILKN X0Y1	HP I/O Bank 46 H	HP I/O Bank 66 D	SYSMON Configuration	GTH Quad 226 X0Y8-X0Y11 C [RS] (RCAL)
GTU Quad 125 X0Y4-X0Y7 (RCAL)	CMAC X0Y0	HP I/O Bank 45 G	HP I/O Bank 65 C	Configuration	GTH Quad 225 X0Y4-X0Y7 B [RS]
GTU Quad 124 X0Y0-X0Y3	ILKN X0Y0	HP I/O Bank 44 F	HR I/O Bank 84/94 B	PCIe X0Y0 (tandem)	GTH Quad 224 X0Y0-X0Y3 A [RS]

X16483-012917

Figure 1-51: XCVU125 Banks in FLVB1760 Package

GTU Quad 133 X0Y36-X0Y39	CMAC X0Y5	HP I/O Bank 53 M	HP I/O Bank 73 Q	PCIe X0Y3	GTH Quad 233 X0Y36-X0Y39 G [RN]
GTU Quad 132 X0Y32-X0Y35 M [LN]	CMAC X0Y4	HP I/O Bank 52 L	HP I/O Bank 72 P	ILKN X1Y5	GTH Quad 232 X0Y32-X0Y35 F [RN]
GTU Quad 131 X0Y28-X0Y31 L [LN]	ILKN X0Y4	HP I/O Bank 51 K	HP I/O Bank 71 O	SYSMON Configuration	GTH Quad 231 X0Y28-X0Y31 E [RN] (RCAL)
GTU Quad 130 X0Y24-X0Y27 K [LN] (RCAL)	CMAC X0Y3	HP I/O Bank 50 J	HP I/O Bank 70 N	Configuration	GTH Quad 230 X0Y24-X0Y27
GTU Quad 129 X0Y20-X0Y23	ILKN X0Y3	HP I/O Bank 49	HR I/O Bank 69	PCIe X0Y2	GTH Quad 229 X0Y20-X0Y23
SLR Crossing					
GTU Quad 128 X0Y16-X0Y19	CMAC X0Y2	HP I/O Bank 48	HP I/O Bank 68	PCIe X0Y1	GTH Quad 228 X0Y16-X0Y19
GTU Quad 127 X0Y12-X0Y15 J [LS]	CMAC X0Y1	HP I/O Bank 47 I	HP I/O Bank 67 E	ILKN X1Y2	GTH Quad 227 X0Y12-X0Y15 D [RS]
GTU Quad 126 X0Y8-X0Y11 I [LS]	ILKN X0Y1	HP I/O Bank 46 H	HP I/O Bank 66 D	SYSMON Configuration	GTH Quad 226 X0Y8-X0Y11 C [RS] (RCAL)
GTU Quad 125 X0Y4-X0Y7 H [LS] (RCAL)	CMAC X0Y0	HP I/O Bank 45 G	HP I/O Bank 65 C	Configuration	GTH Quad 225 X0Y4-X0Y7 B [RS]
GTU Quad 124 X0Y0-X0Y3	ILKN X0Y0	HP I/O Bank 44 F	HR I/O Bank 84/94 B	PCIe X0Y0 (tandem)	GTH Quad 224 X0Y0-X0Y3 A [RS]

X16484-062217

Figure 1-52: XCVU125 Banks in FLVA2104 Package

GTU Quad 133 X0Y36-X0Y39 S [LN]	CMAC X0Y5	HP I/O Bank 53	HP I/O Bank 73	PCIe X0Y3	GTH Quad 233 X0Y36-X0Y39 J [RN]
GTU Quad 132 X0Y32-X0Y35 R [LN]	CMAC X0Y4	HP I/O Bank 52 L	HP I/O Bank 72 O	ILKN X1Y5	GTH Quad 232 X0Y32-X0Y35 I [RN]
GTU Quad 131 X0Y28-X0Y31 Q [LN]	ILKN X0Y4	HP I/O Bank 51 K	HP I/O Bank 71 N	SYSMON Configuration	GTH Quad 231 X0Y28-X0Y31 H [RN] (RCAL)
GTU Quad 130 X0Y24-X0Y27 P [LN] (RCAL)	CMAC X0Y3	HP I/O Bank 50 J	HP I/O Bank 70 M	Configuration	GTH Quad 230 X0Y24-X0Y27 G [RN]
GTU Quad 129 X0Y20-X0Y23 O [LN]	ILKN X0Y3	HP I/O Bank 49	HR I/O Bank 69	PCIe X0Y2	GTH Quad 229 X0Y20-X0Y23 F [RN]
SLR Crossing					
GTU Quad 128 X0Y16-X0Y19 N [LS]	CMAC X0Y2	HP I/O Bank 48	HP I/O Bank 68 F (Partial)	PCIe X0Y1	GTH Quad 228 X0Y16-X0Y19 E [RS]
GTU Quad 127 X0Y12-X0Y15 M [LS]	CMAC X0Y1	HP I/O Bank 47	HP I/O Bank 67 E	ILKN X1Y2	GTH Quad 227 X0Y12-X0Y15 D [RS]
GTU Quad 126 X0Y8-X0Y11 L [LS]	ILKN X0Y1	HP I/O Bank 46 I	HP I/O Bank 66 D	SYSMON Configuration	GTH Quad 226 X0Y8-X0Y11 C [RS] (RCAL)
GTU Quad 125 X0Y4-X0Y7 K [LS] (RCAL)	CMAC X0Y0	HP I/O Bank 45 H	HP I/O Bank 65 C	Configuration	GTH Quad 225 X0Y4-X0Y7 B [RS]
GTU Quad 124 X0Y0-X0Y3 N [LC]	ILKN X0Y0	HP I/O Bank 44 G	HR I/O Bank 84/94 B	PCIe X0Y0 (tandem)	GTH Quad 224 X0Y0-X0Y3 A [RS]

X16485-012917

Figure 1-53: XCVU125 Banks in FLVB2104 Package

GTY Quad 133 X0Y36-X0Y39 W [LN]	CMAC X0Y5	HP I/O Bank 53	HP I/O Bank 73	PCIe X0Y3	GTH Quad 233 X0Y36-X0Y39 J [RN]
GTY Quad 132 X0Y32-X0Y35 V [LN]	CMAC X0Y4	HP I/O Bank 52	HP I/O Bank 72 I	ILKN X1Y5	GTH Quad 232 X0Y32-X0Y35 I [RN]
GTY Quad 131 X0Y28-X0Y31 U [LN]	ILKN X0Y4	HP I/O Bank 51	HP I/O Bank 71 H	SYSMON Configuration	GTH Quad 231 X0Y28-X0Y31 H [RN] (RCAL)
GTY Quad 130 X0Y24-X0Y27 T [LN] (RCAL)	CMAC X0Y3	HP I/O Bank 50	HP I/O Bank 70 G	Configuration	GTH Quad 230 X0Y24-X0Y27 G [RN]
GTY Quad 129 X0Y20-X0Y23 S [LN]	ILKN X0Y3	HP I/O Bank 49	HR I/O Bank 69	PCIe X0Y2	GTH Quad 229 X0Y20-X0Y23 F [RN]
SLR Crossing					
GTY Quad 128 X0Y16-X0Y19 R [LC]	CMAC X0Y2	HP I/O Bank 48	HP I/O Bank 68 F	PCIe X0Y1	GTH Quad 228 X0Y16-X0Y19 E [RC]
GTY Quad 127 X0Y12-X0Y15 Q [LC]	CMAC X0Y1	HP I/O Bank 47	HP I/O Bank 67 E	ILKN X1Y2	GTH Quad 227 X0Y12-X0Y15 D [RC]
GTY Quad 126 X0Y8-X0Y11 P [LC]	ILKN X0Y1	HP I/O Bank 46	HP I/O Bank 66 D	SYSMON Configuration	GTH Quad 226 X0Y8-X0Y11 C [RC] (RCAL)
GTY Quad 125 X0Y4-X0Y7 O [LC] (RCAL)	CMAC X0Y0	HP I/O Bank 45	HP I/O Bank 65 C	Configuration	GTH Quad 225 X0Y4-X0Y7 B [RC]
GTY Quad 124 X0Y0-X0Y3 N [LC]	ILKN X0Y0	HP I/O Bank 44	HR I/O Bank 84/94 B	PCIe X0Y0 (tandem)	GTH Quad 224 X0Y0-X0Y3 A [RC]

X16486-012917

Figure 1-54: XCVU125 Banks in FLVC2104 Package

XCVU160 Bank Diagrams

GTY Quad 133 X0Y52-X0Y55	CMAC X0Y8	HP I/O Bank 53	HP I/O Bank 73	PCIe X0Y4	GTH Quad 233 X0Y52-X0Y55
GTY Quad 132 X0Y45-X0Y51	CMAC X0Y7	HP I/O Bank 52	HP I/O Bank 72	ILKN X1Y7	GTH Quad 232 X0Y45-X0Y51
GTY Quad 131 X0Y44-X0Y47	ILKN X0Y6	HP I/O Bank 51	HP I/O Bank 71	SYSMON Configuration	GTH Quad 231 X0Y44-X0Y47 (RCAL)
GTY Quad 130 X0Y40-X0Y43 (RCAL)	CMAC X0Y6	HP I/O Bank 50	HP I/O Bank 70	Configuration	GTH Quad 230 X0Y40-X0Y43
GTY Quad 129 X0Y36-X0Y39	ILKN X0Y5	HP I/O Bank 49	HR I/O Bank 69	PCIe X0Y3	GTH Quad 229 X0Y36-X0Y39
SLR Crossing					
GTY Quad 128 X0Y32-X0Y35	CMAC X0Y5	HP I/O Bank 48	HP I/O Bank 68	PCIe X0Y2	GTH Quad 228 X0Y32-X0Y35
GTY Quad 127 X0Y28-X0Y31	CMAC X0Y4	HP I/O Bank 47	HP I/O Bank 67	ILKN X1Y4	GTH Quad 227 X0Y28-X0Y31
GTY Quad 126 X0Y24-X0Y27	ILKN X0Y2	HP I/O Bank 46	HP I/O Bank 66	SYSMON Configuration	GTH Quad 226 X0Y24-X0Y27 (RCAL)
GTY Quad 125 X0Y20-X0Y23 (RCAL)	CMAC X0Y3	HP I/O Bank 45	HP I/O Bank 65	Configuration	GTH Quad 225 X0Y20-X0Y23
GTY Quad 124 X0Y16-X0Y19	ILKN X0Y2	HP I/O Bank 44	HR I/O Bank 84/94	PCIe X0Y1 (tandem)	GTH Quad 224 X0Y16-X0Y19
SLR Crossing					
GTY Quad 123 X0Y12-X0Y15	CMAC X0Y2	HP I/O Bank 43	HP I/O Bank 63	PCIe X0Y0	GTH Quad 223 X0Y12-X0Y15
GTY Quad 122 X0Y8-X0Y11	CMAC X0Y1	HP I/O Bank 42	HP I/O Bank 62	ILKN X1Y1	GTH Quad 222 X0Y8-X0Y11
GTY Quad 121 X0Y4-X0Y7	ILKN X0Y0	HP I/O Bank 41	HP I/O Bank 61	SYSMON Configuration	GTH Quad 221 X0Y4-X0Y7 (RCAL)
GTY Quad 120 X0Y0-X0Y3 (RCAL)	CMAC X0Y0	HP I/O Bank 40	HP I/O Bank 60	Configuration	GTH Quad 220 X0Y0-X0Y3

X16488-012917

Figure 1-55: XCVU160 Banks

GTY Quad 133 X0Y52-X0Y55 S [LN]	CMAC X0Y8	HP I/O Bank 53	HP I/O Bank 73	PCIe X0Y4	GTH Quad 233 X0Y52-X0Y55 J [RN]
GTY Quad 132 X0Y45-X0Y51 R [LN]	CMAC X0Y7	HP I/O Bank 52 L	HP I/O Bank 72 O	ILKN X1Y7	GTH Quad 232 X0Y45-X0Y51 I [RN]
GTY Quad 131 X0Y44-X0Y47 Q [LN]	ILKN X0Y6	HP I/O Bank 51 K	HP I/O Bank 71 N	SYSMON Configuration	GTH Quad 231 X0Y44-X0Y47 H [RN] (RCAL)
GTY Quad 130 X0Y40-X0Y43 P [LN] (RCAL)	CMAC X0Y6	HP I/O Bank 50 J	HP I/O Bank 70 M	Configuration	GTH Quad 230 X0Y40-X0Y43 G [RN]
GTY Quad 129 X0Y36-X0Y39 O [LN]	ILKN X0Y5	HP I/O Bank 49	HR I/O Bank 69	PCIe X0Y3	GTH Quad 229 X0Y36-X0Y39 F [RN]
SLR Crossing					
GTY Quad 128 X0Y32-X0Y35 N [LS]	CMAC X0Y5	HP I/O Bank 48	HP I/O Bank 68 F (Partial)	PCIe X0Y2	GTH Quad 228 X0Y32-X0Y35 E [RS]
GTY Quad 127 X0Y28-X0Y31 M [LS]	CMAC X0Y4	HP I/O Bank 47	HP I/O Bank 67 E	ILKN X1Y4	GTH Quad 227 X0Y28-X0Y31 D [RS]
GTY Quad 126 X0Y24-X0Y27 L [LS]	ILKN X0Y2	HP I/O Bank 46 I	HP I/O Bank 66 D	SYSMON Configuration	GTH Quad 226 X0Y24-X0Y27 C [RS] (RCAL)
GTY Quad 125 X0Y20-X0Y23 K [LS] (RCAL)	CMAC X0Y3	HP I/O Bank 45 H	HP I/O Bank 65 C	Configuration	GTH Quad 225 X0Y20-X0Y23 B [RS]
GTY Quad 124 X0Y16-X0Y19	ILKN X0Y2	HP I/O Bank 44 G	HR I/O Bank 84/94 B	PCIe X0Y1 (tandem)	GTH Quad 224 X0Y16-X0Y19 A [RS]
SLR Crossing					
GTY Quad 123 X0Y12-X0Y15	CMAC X0Y2	HP I/O Bank 43	HP I/O Bank 63	PCIe X0Y0	GTH Quad 223 X0Y12-X0Y15
GTY Quad 122 X0Y8-X0Y11	CMAC X0Y1	HP I/O Bank 42	HP I/O Bank 62	ILKN X1Y1	GTH Quad 222 X0Y8-X0Y11
GTY Quad 121 X0Y4-X0Y7	ILKN X0Y0	HP I/O Bank 41	HP I/O Bank 61	SYSMON Configuration	GTH Quad 221 X0Y4-X0Y7 (RCAL)
GTY Quad 120 X0Y0-X0Y3 (RCAL)	CMAC X0Y0	HP I/O Bank 40	HP I/O Bank 60	Configuration	GTH Quad 220 X0Y0-X0Y3

X16489-012917

Figure 1-56: XCVU160 Banks in FLGB2104 Package

GTU Quad 133 X0Y52-X0Y55 W [LN]	CMAC X0Y8	HP I/O Bank 53	HP I/O Bank 73	PCle X0Y4	GTH Quad 233 X0Y52-X0Y55 J [RN]
GTU Quad 132 X0Y45-X0Y51 V [LN]	CMAC X0Y7	HP I/O Bank 52 L	HP I/O Bank 72 I	ILKN X1Y7	GTH Quad 232 X0Y45-X0Y51 I [RN]
GTU Quad 131 X0Y44-X0Y47 U [LN]	ILKN X0Y6	HP I/O Bank 51 K	HP I/O Bank 71 H	SYSMON Configuration	GTH Quad 231 X0Y44-X0Y47 H [RN] (RCAL)
GTU Quad 130 X0Y40-X0Y43 T [LN] (RCAL)	CMAC X0Y6	HP I/O Bank 50 J	HP I/O Bank 70 G	Configuration	GTH Quad 230 X0Y40-X0Y43 G [RN]
GTU Quad 129 X0Y36-X0Y39 S [LN]	ILKN X0Y5	HP I/O Bank 49	HR I/O Bank 69	PCle X0Y3	GTH Quad 229 X0Y36-X0Y39 F [RN]
SLR Crossing					
GTU Quad 128 X0Y32-X0Y35 R [LC]	CMAC X0Y5	HP I/O Bank 48	HP I/O Bank 68 F	PCle X0Y2	GTH Quad 228 X0Y32-X0Y35 E [RC]
GTU Quad 127 X0Y28-X0Y31 Q [LC]	CMAC X0Y4	HP I/O Bank 47	HP I/O Bank 67 E	ILKN X1Y4	GTH Quad 227 X0Y28-X0Y31 D [RC]
GTU Quad 126 X0Y24-X0Y27 P [LC]	ILKN X0Y2	HP I/O Bank 46 I	HP I/O Bank 66 D	SYSMON Configuration	GTH Quad 226 X0Y24-X0Y27 C [RC] (RCAL)
GTU Quad 125 X0Y20-X0Y23 O [LC] (RCAL)	CMAC X0Y3	HP I/O Bank 45 H	HP I/O Bank 65 C	Configuration	GTH Quad 225 X0Y20-X0Y23 B [RC]
GTU Quad 124 X0Y16-X0Y19 N [LC]	ILKN X0Y2	HP I/O Bank 44 G	HR I/O Bank 84/94 B	PCle X0Y1 (tandem)	GTH Quad 224 X0Y16-X0Y19 A [RC]
SLR Crossing					
GTU Quad 123 X0Y12-X0Y15	CMAC X0Y2	HP I/O Bank 43	HP I/O Bank 63	PCle X0Y0	GTH Quad 223 X0Y12-X0Y15
GTU Quad 122 X0Y8-X0Y11 Z [LS]	CMAC X0Y1	HP I/O Bank 42	HP I/O Bank 62	ILKN X1Y1	GTH Quad 222 X0Y8-X0Y11 M [RS]
GTU Quad 121 X0Y4-X0Y7 Y [LS]	ILKN X0Y0	HP I/O Bank 41	HP I/O Bank 61	SYSMON Configuration	GTH Quad 221 X0Y4-X0Y7 L [RS] (RCAL)
GTU Quad 120 X0Y0-X0Y3 X [LS] (RCAL)	CMAC X0Y0	HP I/O Bank 40	HP I/O Bank 60	Configuration	GTH Quad 220 X0Y0-X0Y3 K [RS]

X16490-012917

Figure 1-57: XCVU160 Banks in FLGC2104 Package

XCVU190 Bank Diagrams

GTY Quad 133 X0Y56-X0Y59	CMAC X0Y8	HP I/O Bank 53	HP I/O Bank 73	PCIe X0Y5	GTH Quad 233 X0Y56-X0Y59
GTY Quad 132 X0Y52-X0Y55	CMAC X0Y7	HP I/O Bank 52	HP I/O Bank 72	ILKN X1Y8	GTH Quad 232 X0Y52-X0Y55
GTY Quad 131 X0Y48-X0Y51	ILKN X0Y7	HP I/O Bank 51	HP I/O Bank 71	SYSMON Configuration	GTH Quad 231 X0Y48-X0Y51 (RCAL)
GTY Quad 130 X0Y44-X0Y47 (RCAL)	CMAC X0Y6	HP I/O Bank 50	HP I/O Bank 70	Configuration	GTH Quad 230 X0Y44-X0Y47
GTY Quad 129 X0Y40-X0Y43	ILKN X0Y6	HP I/O Bank 49	HR I/O Bank 69	PCIe X0Y4	GTH Quad 229 X0Y40-X0Y43
SLR Crossing					
GTY Quad 128 X0Y36-X0Y39	CMAC X0Y5	HP I/O Bank 48	HP I/O Bank 68	PCIe X0Y3	GTH Quad 228 X0Y36-X0Y39
GTY Quad 127 X0Y32-X0Y35	CMAC X0Y4	HP I/O Bank 47	HP I/O Bank 67	ILKN X1Y5	GTH Quad 227 X0Y32-X0Y35
GTY Quad 126 X0Y28-X0Y31	ILKN X0Y4	HP I/O Bank 46	HP I/O Bank 66	SYSMON Configuration	GTH Quad 226 X0Y28-X0Y31 (RCAL)
GTY Quad 125 X0Y24-X0Y27 (RCAL)	CMAC X0Y3	HP I/O Bank 45	HP I/O Bank 65	Configuration	GTH Quad 225 X0Y24-X0Y27
GTY Quad 124 X0Y20-X0Y23	ILKN X0Y3	HP I/O Bank 44	HR I/O Bank 84/94	PCIe X0Y2 (tandem)	GTH Quad 224 X0Y20-X0Y23
SLR Crossing					
GTY Quad 123 X0Y16-X0Y19	CMAC X0Y2	HP I/O Bank 43	HP I/O Bank 63	PCIe X0Y1	GTH Quad 223 X0Y16-X0Y19
GTY Quad 122 X0Y12-X0Y15	CMAC X0Y1	HP I/O Bank 42	HP I/O Bank 62	ILKN X1Y2	GTH Quad 222 X0Y12-X0Y15
GTY Quad 121 X0Y8-X0Y11	ILKN X0Y1	HP I/O Bank 41	HP I/O Bank 61	SYSMON Configuration	GTH Quad 221 X0Y8-X0Y11 (RCAL)
GTY Quad 120 X0Y4-X0Y7 (RCAL)	CMAC X0Y0	HP I/O Bank 40	HP I/O Bank 60	Configuration	GTH Quad 220 X0Y4-X0Y7
GTY Quad 119 X0Y0-X0Y3	ILKN X0Y0	HP I/O Bank 39	HR I/O Bank 59	PCIe X0Y0	GTH Quad 219 X0Y0-X0Y3

X16491-012917

Figure 1-58: XCVU190 Banks

GTU Quad 133 X0Y56-X0Y59 S [LN]	CMAC X0Y8	HP I/O Bank 53	HP I/O Bank 73	PCIe X0Y5	GTH Quad 233 X0Y56-X0Y59 J [RN]
GTU Quad 132 X0Y52-X0Y55 R [LN]	CMAC X0Y7	HP I/O Bank 52 L	HP I/O Bank 72 O	ILKN X1Y8	GTH Quad 232 X0Y52-X0Y55 I [RN]
GTU Quad 131 X0Y48-X0Y51 Q [LN]	ILKN X0Y7	HP I/O Bank 51 K	HP I/O Bank 71 N	SYSMON Configuration	GTH Quad 231 X0Y48-X0Y51 H [RN] (RCAL)
GTU Quad 130 X0Y44-X0Y47 P [LN] (RCAL)	CMAC X0Y6	HP I/O Bank 50 J	HP I/O Bank 70 M	Configuration	GTH Quad 230 X0Y44-X0Y47 G [RN]
GTU Quad 129 X0Y40-X0Y43 O [LN]	ILKN X0Y6	HP I/O Bank 49	HR I/O Bank 69	PCIe X0Y4	GTH Quad 229 X0Y40-X0Y43 F [RN]
SLR Crossing					
GTU Quad 128 X0Y36-X0Y39 N [LS]	CMAC X0Y5	HP I/O Bank 48	HP I/O Bank 68 F (Partial)	PCIe X0Y3	GTH Quad 228 X0Y36-X0Y39 E [RS]
GTU Quad 127 X0Y32-X0Y35 M [LS]	CMAC X0Y4	HP I/O Bank 47	HP I/O Bank 67 E	ILKN X1Y5	GTH Quad 227 X0Y32-X0Y35 D [RS]
GTU Quad 126 X0Y28-X0Y31 L [LS]	ILKN X0Y4	HP I/O Bank 46 I	HP I/O Bank 66 D	SYSMON Configuration	GTH Quad 226 X0Y28-X0Y31 C [RS] (RCAL)
GTU Quad 125 X0Y24-X0Y27 K [LS] (RCAL)	CMAC X0Y3	HP I/O Bank 45 H	HP I/O Bank 65 C	Configuration	GTH Quad 225 X0Y24-X0Y27 B [RS]
GTU Quad 124 X0Y20-X0Y23	ILKN X0Y3	HP I/O Bank 44 G	HR I/O Bank 84/94 B	PCIe X0Y2 (tandem)	GTH Quad 224 X0Y20-X0Y23 A [RS]
SLR Crossing					
GTU Quad 123 X0Y16-X0Y19	CMAC X0Y2	HP I/O Bank 43	HP I/O Bank 63	PCIe X0Y1	GTH Quad 223 X0Y16-X0Y19
GTU Quad 122 X0Y12-X0Y15	CMAC X0Y1	HP I/O Bank 42	HP I/O Bank 62	ILKN X1Y2	GTH Quad 222 X0Y12-X0Y15
GTU Quad 121 X0Y8-X0Y11	ILKN X0Y1	HP I/O Bank 41	HP I/O Bank 61	SYSMON Configuration	GTH Quad 221 X0Y8-X0Y11 (RCAL)
GTU Quad 120 X0Y4-X0Y7 (RCAL)	CMAC X0Y0	HP I/O Bank 40	HP I/O Bank 60	Configuration	GTH Quad 220 X0Y4-X0Y7
GTU Quad 119 X0Y0-X0Y3	ILKN X0Y0	HP I/O Bank 39	HR I/O Bank 59	PCIe X0Y0	GTH Quad 219 X0Y0-X0Y3

X16492-012917

Figure 1-59: XCVU190 Banks in FLGB2104 Package

GTY Quad 133 X0Y56-X0Y59 W [LN]	CMAC X0Y8	HP I/O Bank 53	HP I/O Bank 73	PCIe X0Y5	GTH Quad 233 X0Y56-X0Y59 J [RN]
GTY Quad 132 X0Y52-X0Y55 V [LN]	CMAC X0Y7	HP I/O Bank 52 L	HP I/O Bank 72 I	ILKN X1Y8	GTH Quad 232 X0Y52-X0Y55 I [RN]
GTY Quad 131 X0Y48-X0Y51 U [LN]	ILKN X0Y7	HP I/O Bank 51 K	HP I/O Bank 71 H	SYSMON Configuration	GTH Quad 231 X0Y48-X0Y51 H [RN] (RCAL)
GTY Quad 130 X0Y44-X0Y47 T [LN] (RCAL)	CMAC X0Y6	HP I/O Bank 50 J	HP I/O Bank 70 G	Configuration	GTH Quad 230 X0Y44-X0Y47 G [RN]
GTY Quad 129 X0Y40-X0Y43 S [LN]	ILKN X0Y6	HP I/O Bank 49	HR I/O Bank 69	PCIe X0Y4	GTH Quad 229 X0Y40-X0Y43 F [RN]
SLR Crossing					
GTY Quad 128 X0Y36-X0Y39 R [LC]	CMAC X0Y5	HP I/O Bank 48	HP I/O Bank 68 F	PCIe X0Y3	GTH Quad 228 X0Y36-X0Y39 E [RC]
GTY Quad 127 X0Y32-X0Y35 Q [LC]	CMAC X0Y4	HP I/O Bank 47	HP I/O Bank 67 E	ILKN X1Y5	GTH Quad 227 X0Y32-X0Y35 D [RC]
GTY Quad 126 X0Y28-X0Y31 P [LC]	ILKN X0Y4	HP I/O Bank 46 I	HP I/O Bank 66 D	SYSMON Configuration	GTH Quad 226 X0Y28-X0Y31 C [RC] (RCAL)
GTY Quad 125 X0Y24-X0Y27 O [LC] (RCAL)	CMAC X0Y3	HP I/O Bank 45 H	HP I/O Bank 65 C	Configuration	GTH Quad 225 X0Y24-X0Y27 B [RC]
GTY Quad 124 X0Y20-X0Y23 N [LC]	ILKN X0Y3	HP I/O Bank 44 G	HR I/O Bank 84/94 B	PCIe X0Y2 (tandem)	GTH Quad 224 X0Y20-X0Y23 A [RC]
SLR Crossing					
GTY Quad 123 X0Y16-X0Y19	CMAC X0Y2	HP I/O Bank 43	HP I/O Bank 63	PCIe X0Y1	GTH Quad 223 X0Y16-X0Y19
GTY Quad 122 X0Y12-X0Y15 Z [LS]	CMAC X0Y1	HP I/O Bank 42	HP I/O Bank 62	ILKN X1Y2	GTH Quad 222 X0Y12-X0Y15 M [RS]
GTY Quad 121 X0Y8-X0Y11 Y [LS]	ILKN X0Y1	HP I/O Bank 41	HP I/O Bank 61	SYSMON Configuration	GTH Quad 221 X0Y8-X0Y11 L [RS] (RCAL)
GTY Quad 120 X0Y4-X0Y7 X [LS] (RCAL)	CMAC X0Y0	HP I/O Bank 40	HP I/O Bank 60	Configuration	GTH Quad 220 X0Y4-X0Y7 K [RS]
GTY Quad 119 X0Y0-X0Y3	ILKN X0Y0	HP I/O Bank 39	HR I/O Bank 59	PCIe X0Y0	GTH Quad 219 X0Y0-X0Y3

X16493-012917

Figure 1-60: XCVU190 Banks in FLGC2104 Package

GTU Quad 133 X0Y56-X0Y59 Z [LN]	CMAC X0Y8	HP I/O Bank 53	HP I/O Bank 73	PCIe X0Y5	GTH Quad 233 X0Y56-X0Y59 J [RN]
GTU Quad 132 X0Y52-X0Y55 Y [LN]	CMAC X0Y7	HP I/O Bank 52	HP I/O Bank 72 K	ILKN X1Y8	GTH Quad 232 X0Y52-X0Y55 I [RN]
GTU Quad 131 X0Y48-X0Y51 X [LN]	ILKN X0Y7	HP I/O Bank 51	HP I/O Bank 71 J	SYSMON Configuration	GTH Quad 231 X0Y48-X0Y51 H [RN] (RCAL)
GTU Quad 130 X0Y44-X0Y47 W [LUC] (RCAL)	CMAC X0Y6	HP I/O Bank 50	HP I/O Bank 70 I	Configuration	GTH Quad 230 X0Y44-X0Y47 G [RUC]
GTU Quad 129 X0Y40-X0Y43 V [LUC]	ILKN X0Y6	HP I/O Bank 49	HR I/O Bank 69	PCIe X0Y4	GTH Quad 229 X0Y40-X0Y43 F [RUC]
SLR Crossing					
GTU Quad 128 X0Y36-X0Y39 U [LUC]	CMAC X0Y5	HP I/O Bank 48	HP I/O Bank 68 H (Partial)	PCIe X0Y3	GTH Quad 228 X0Y36-X0Y39 E [RUC]
GTU Quad 127 X0Y32-X0Y35 T [LUC]	CMAC X0Y4	HP I/O Bank 47	HP I/O Bank 67 G	ILKN X1Y5	GTH Quad 227 X0Y32-X0Y35 D [RUC]
GTU Quad 126 X0Y28-X0Y31 S [LLC]	ILKN X0Y4	HP I/O Bank 46	HP I/O Bank 66 B (Partial)	SYSMON Configuration	GTH Quad 226 X0Y28-X0Y31 C [RLC] (RCAL)
GTU Quad 125 X0Y24-X0Y27 R [LLC] (RCAL)	CMAC X0Y3	HP I/O Bank 45	HP I/O Bank 65 C	Configuration	GTH Quad 225 X0Y24-X0Y27 B [RLC]
GTU Quad 124 X0Y20-X0Y23 Q [LLC]	ILKN X0Y3	HP I/O Bank 44	HR I/O Bank 84/94	PCIe X0Y2 (tandem)	GTH Quad 224 X0Y20-X0Y23 A [RLC]
SLR Crossing					
GTU Quad 123 X0Y16-X0Y19 AF [LLC]	CMAC X0Y2	HP I/O Bank 43	HP I/O Bank 63 F	PCIe X0Y1	GTH Quad 223 X0Y16-X0Y19 P [RLC]
GTU Quad 122 X0Y12-X0Y15 AE [LS]	CMAC X0Y1	HP I/O Bank 42	HP I/O Bank 62 E	ILKN X1Y2	GTH Quad 222 X0Y12-X0Y15 O [RS]
GTU Quad 121 X0Y8-X0Y11 AD [LS]	ILKN X0Y1	HP I/O Bank 41	HP I/O Bank 61 D	SYSMON Configuration	GTH Quad 221 X0Y8-X0Y11 N [RS] (RCAL)
GTU Quad 120 X0Y4-X0Y7 AC [LS] (RCAL)	CMAC X0Y0	HP I/O Bank 40	HP I/O Bank 60	Configuration	GTH Quad 220 X0Y4-X0Y7 M [RS]
GTU Quad 119 X0Y0-X0Y3 AB [LS]	ILKN X0Y0	HP I/O Bank 39	HR I/O Bank 59	PCIe X0Y0	GTH Quad 219 X0Y0-X0Y3 L [RS]

X16494-012917

Figure 1-61: XCVU190 Banks in FLGA2577 Package

XCVU440 Bank Diagrams

HP I/O Bank 53	HP I/O Bank 73	PCIe X0Y5	GTH Quad 233 X0Y56-X0Y59
HP I/O Bank 52	HP I/O Bank 72	CMAC X0Y2	GTH Quad 232 X0Y52-X0Y55
HP I/O Bank 51	HP I/O Bank 71	SYSMON Configuration	GTH Quad 231 X0Y48-X0Y51 (RCAL)
HP I/O Bank 50	HP I/O Bank 70	Configuration	GTH Quad 230 X0Y44-X0Y47
HP I/O Bank 49	HR I/O Bank 69	PCIe X0Y4	GTH Quad 229 X0Y40-X0Y43
SLR Crossing			
HP I/O Bank 48	HP I/O Bank 68	PCIe X0Y3	GTH Quad 228 X0Y36-X0Y39
HP I/O Bank 47	HP I/O Bank 67	CMAC X0Y1	GTH Quad 227 X0Y32-X0Y35
HP I/O Bank 46	HP I/O Bank 66	SYSMON Configuration	GTH Quad 226 X0Y28-X0Y31 (RCAL)
HP I/O Bank 45	HP I/O Bank 65	Configuration	GTH Quad 225 X0Y24-X0Y27
HP I/O Bank 44	HR I/O Bank 84/94	PCIe X0Y2 (tandem)	GTH Quad 224 X0Y20-X0Y23
SLR Crossing			
HP I/O Bank 43	HP I/O Bank 63	PCIe X0Y1	GTH Quad 223 X0Y16-X0Y19
HP I/O Bank 42	HP I/O Bank 62	CMAC X0Y0	GTH Quad 222 X0Y12-X0Y15
HP I/O Bank 41	HP I/O Bank 61	SYSMON Configuration	GTH Quad 221 X0Y8-X0Y11 (RCAL)
HP I/O Bank 40	HP I/O Bank 60	Configuration	GTH Quad 220 X0Y4-X0Y7
HP I/O Bank 39	HR I/O Bank 59	PCIe X0Y0	GTH Quad 219 X0Y0-X0Y3

X16497-012917

Figure 1-62: XCVU440 Banks

HP I/O Bank 53 V	HP I/O Bank 73 Z	PCIe X0Y5	GTH Quad 233 X0Y56-X0Y59 F [RN]
HP I/O Bank 52 U	HP I/O Bank 72 Y	CMAC X0Y2	GTH Quad 232 X0Y52-X0Y55 E [RN]
HP I/O Bank 51 T	HP I/O Bank 71 X	SYSMON Configuration	GTH Quad 231 X0Y48-X0Y51 D [RN] (RCAL)
HP I/O Bank 50 S	HP I/O Bank 70 W	Configuration	GTH Quad 230 X0Y44-X0Y47
HP I/O Bank 49	HR I/O Bank 69	PCIe X0Y4	GTH Quad 229 X0Y40-X0Y43
SLR Crossing			
HP I/O Bank 48 R	HP I/O Bank 68 F	PCIe X0Y3	GTH Quad 228 X0Y36-X0Y39
HP I/O Bank 47 Q	HP I/O Bank 67 E	CMAC X0Y1	GTH Quad 227 X0Y32-X0Y35
HP I/O Bank 46 P	HP I/O Bank 66 D	SYSMON Configuration	GTH Quad 226 X0Y28-X0Y31 C [RC] (RCAL)
HP I/O Bank 45 O	HP I/O Bank 65 C	Configuration	GTH Quad 225 X0Y24-X0Y27 B [RC]
HP I/O Bank 44	HR I/O Bank 84/94 B	PCIe X0Y2 (tandem)	GTH Quad 224 X0Y20-X0Y23 A [RC]
SLR Crossing			
HP I/O Bank 43 N	HP I/O Bank 63 J	PCIe X0Y1	GTH Quad 223 X0Y16-X0Y19 I [RS]
HP I/O Bank 42 M	HP I/O Bank 62 I	CMAC X0Y0	GTH Quad 222 X0Y12-X0Y15 H [RS]
HP I/O Bank 41 L	HP I/O Bank 61 H	SYSMON Configuration	GTH Quad 221 X0Y8-X0Y11 G [RS] (RCAL)
HP I/O Bank 40 K	HP I/O Bank 60 G	Configuration	GTH Quad 220 X0Y4-X0Y7
HP I/O Bank 39	HR I/O Bank 59	PCIe X0Y0	GTH Quad 219 X0Y0-X0Y3

X16498-012917

Figure 1-63: XCVU440 Banks in FLGB2377 Package

HP I/O Bank 53 Y	HP I/O Bank 73 AC	PCIe X0Y5	GTH Quad 233 X0Y56-X0Y59
HP I/O Bank 52 X	HP I/O Bank 72 AB	CMAC X0Y2	GTH Quad 232 X0Y52-X0Y55 H [RN]
HP I/O Bank 51 W	HP I/O Bank 71 AA	SYSMON Configuration	GTH Quad 231 X0Y48-X0Y51 G [RN] (RCAL)
HP I/O Bank 50 V	HP I/O Bank 70 Z	Configuration	GTH Quad 230 X0Y44-X0Y47 F [RN]
HP I/O Bank 49 U	HR I/O Bank 69	PCIe X0Y4	GTH Quad 229 X0Y40-X0Y43 E [RN]
SLR Crossing			
HP I/O Bank 48 T	HP I/O Bank 68 F	PCIe X0Y3	GTH Quad 228 X0Y36-X0Y39
HP I/O Bank 47 S	HP I/O Bank 67 E	CMAC X0Y1	GTH Quad 227 X0Y32-X0Y35 D [RC]
HP I/O Bank 46 R	HP I/O Bank 66 D	SYSMON Configuration	GTH Quad 226 X0Y28-X0Y31 C [RC] (RCAL)
HP I/O Bank 45 Q	HP I/O Bank 65 C	Configuration	GTH Quad 225 X0Y24-X0Y27 B [RC]
HP I/O Bank 44 P	HR I/O Bank 84/94 B	PCIe X0Y2 (tandem)	GTH Quad 224 X0Y20-X0Y23 A [RC]
SLR Crossing			
HP I/O Bank 43 O	HP I/O Bank 63 J	PCIe X0Y1	GTH Quad 223 X0Y16-X0Y19
HP I/O Bank 42 N	HP I/O Bank 62 I	CMAC X0Y0	GTH Quad 222 X0Y12-X0Y15 L [RS]
HP I/O Bank 41 M	HP I/O Bank 61 H	SYSMON Configuration	GTH Quad 221 X0Y8-X0Y11 K [RS] (RCAL)
HP I/O Bank 40 L	HP I/O Bank 60 G	Configuration	GTH Quad 220 X0Y4-X0Y7 J [RS]
HP I/O Bank 39 K	HR I/O Bank 59	PCIe X0Y0	GTH Quad 219 X0Y0-X0Y3 I [RS]

X16496-012917

Figure 1-64: XCVU440 Banks in FLGA2892 Package

XCKU3P Bank Diagrams

HP I/O Bank 67	HD I/O Bank 87	CMAC X0Y0	GTY Quad 227 X0Y12-X0Y15
HP I/O Bank 66	HD I/O Bank 86	SYSMON Configuration	GTY Quad 226 X0Y8-X0Y11
HP I/O Bank 65	HD I/O Bank 85	Configuration	GTY Quad 225 X0Y4-X0Y7 (RCAL)
HP I/O Bank 64	HD I/O Bank 84	PCIE4 X0Y0 (tandem)	GTY Quad 224 X0Y0-X0Y3

X15536-020817

Figure 1-65: XCKU3P Banks

HP I/O Bank 67 G	HD I/O Bank 87	CMAC X0Y0	GTY Quad 227 X0Y12-X0Y15 D [R]
HP I/O Bank 66 D	HD I/O Bank 86	SYSMON Configuration	GTY Quad 226 X0Y8-X0Y11 C [R]
HP I/O Bank 65 C	HD I/O Bank 85 R	Configuration	GTY Quad 225 X0Y4-X0Y7 B [R] (RCAL)
HP I/O Bank 64 E	HD I/O Bank 84 R	PCIE4 X0Y0 (tandem)	GTY Quad 224 X0Y0-X0Y3 A [R]

X15538-020817

Figure 1-66: XCKU3P Banks in FFVA676 Package

HP I/O Bank 67 E	HD I/O Bank 87 G	CMAC X0Y0	GTY Quad 227 X0Y12-X0Y15 D [R]
HP I/O Bank 66 D	HD I/O Bank 86 F	SYSMON Configuration	GTY Quad 226 X0Y8-X0Y11 C [R]
HP I/O Bank 65 C	HD I/O Bank 85	Configuration	GTY Quad 225 X0Y4-X0Y7 B [R] (RCAL)
HP I/O Bank 64 B	HD I/O Bank 84 A	PCIE4 X0Y0 (tandem)	GTY Quad 224 X0Y0-X0Y3 A [R]

X16502-020817

Figure 1-67: XCKU3P Banks in FFVB676 Package

HP I/O Bank 67 E	HD I/O Bank 87 F	CMAC X0Y0	GTY Quad 227 X0Y12-X0Y15 D [R]
HP I/O Bank 66 D	HD I/O Bank 86 G	SYSMON Configuration	GTY Quad 226 X0Y8-X0Y11 C [R]
HP I/O Bank 65 C	HD I/O Bank 85 I	Configuration	GTY Quad 225 X0Y4-X0Y7 B [R] (RCAL)
HP I/O Bank 64 B	HD I/O Bank 84 H	PCIE4 X0Y0 (tandem)	GTY Quad 224 X0Y0-X0Y3 A [R]

X15537-020817

Figure 1-68: XCKU3P Banks in SFVB784 Package

HP I/O Bank 67 F	HD I/O Bank 87 K	CMAC X0Y0	GTY Quad 227 X0Y12-X0Y15 D [R]
HP I/O Bank 66 D	HD I/O Bank 86 L	SYSMON Configuration	GTY Quad 226 X0Y8-X0Y11 C [R]
HP I/O Bank 65 C	HD I/O Bank 85 J	Configuration	GTY Quad 225 X0Y4-X0Y7 B [R] (RCAL)
HP I/O Bank 64 E	HD I/O Bank 84 I	PCIE4 X0Y0 (tandem)	GTY Quad 224 X0Y0-X0Y3 A [R]

X16503-020817

Figure 1-69: XCKU3P Banks in FFVD900 Package

XCKU5P and XQKU5P Bank Diagrams

HP I/O Bank 67	HD I/O Bank 87	CMAC X0Y0	GTY Quad 227 X0Y12-X0Y15
HP I/O Bank 66	HD I/O Bank 86	SYSMON Configuration	GTY Quad 226 X0Y8-X0Y11
HP I/O Bank 65	HD I/O Bank 85	Configuration	GTY Quad 225 X0Y4-X0Y7 (RCAL)
HP I/O Bank 64	HD I/O Bank 84	PCIE4 X0Y0 (tandem)	GTY Quad 224 X0Y0-X0Y3

X15539-020817

Figure 1-70: XCKU5P and XQKU5P Banks

HP I/O Bank 67 G	HD I/O Bank 87	CMAC X0Y0	GTY Quad 227 X0Y12-X0Y15 D [R]
HP I/O Bank 66 D	HD I/O Bank 86	SYSMON Configuration	GTY Quad 226 X0Y8-X0Y11 C [R]
HP I/O Bank 65 C	HD I/O Bank 85 R	Configuration	GTY Quad 225 X0Y4-X0Y7 B [R] (RCAL)
HP I/O Bank 64 E	HD I/O Bank 84 R	PCIE4 X0Y0 (tandem)	GTY Quad 224 X0Y0-X0Y3 A [R]

X15588-020817

Figure 1-71: XCKU5P Banks in FFVA676 Package

HP I/O Bank 67 E	HD I/O Bank 87 G	CMAC X0Y0	GTY Quad 227 X0Y12-X0Y15 D [R]
HP I/O Bank 66 D	HD I/O Bank 86 F	SYSMON Configuration	GTY Quad 226 X0Y8-X0Y11 C [R]
HP I/O Bank 65 C	HD I/O Bank 85	Configuration	GTY Quad 225 X0Y4-X0Y7 B [R] (RCAL)
HP I/O Bank 64 B	HD I/O Bank 84 A	PCIE4 X0Y0 (tandem)	GTY Quad 224 X0Y0-X0Y3 A [R]

X15586-020817

Figure 1-72: XCKU5P Banks in FFVB676 Package and XQKU5P Banks in FFRB676 Package

HP I/O Bank 67 E	HD I/O Bank 87 F	CMAC X0Y0	GTY Quad 227 X0Y12-X0Y15 D [R]
HP I/O Bank 66 D	HD I/O Bank 86 G	SYSMON Configuration	GTY Quad 226 X0Y8-X0Y11 C [R]
HP I/O Bank 65 C	HD I/O Bank 85 I	Configuration	GTY Quad 225 X0Y4-X0Y7 B [R] (RCAL)
HP I/O Bank 64 B	HD I/O Bank 84 H	PCIE4 X0Y0 (tandem)	GTY Quad 224 X0Y0-X0Y3 A [R]

X15587-020817

Figure 1-73: XCKU5P Banks in SFVB784 Package and XQKU5P Banks in SFRB784 Package

HP I/O Bank 67 F	HD I/O Bank 87 K	CMAC X0Y0	GTY Quad 227 X0Y12-X0Y15 D [R]
HP I/O Bank 66 D	HD I/O Bank 86 L	SYSMON Configuration	GTY Quad 226 X0Y8-X0Y11 C [R]
HP I/O Bank 65 C	HD I/O Bank 85 J	Configuration	GTY Quad 225 X0Y4-X0Y7 B [R] (RCAL)
HP I/O Bank 64 E	HD I/O Bank 84 I	PCIE4 X0Y0 (tandem)	GTY Quad 224 X0Y0-X0Y3 A [R]

X15589-020817

Figure 1-74: XCKU5P Banks in FFVD900 Package

XCKU9P Bank Diagrams

GTH Quad 130 X0Y12-X0Y15	HD I/O Bank 50	GTH Quad 230 X1Y12-X1Y15
GTH Quad 129 X0Y8-X0Y11	HD I/O Bank 49	GTH Quad 229 X1Y8-X1Y11
GTH Quad 128 X0Y4-X0Y7 (RCAL)	HD I/O Bank 48	GTH Quad 228 X1Y4-X1Y7 (RCAL)
GTH Quad 127 X0Y0-X0Y3	HD I/O Bank 47	HP I/O Bank 67
	SYSMON Configuration	HP I/O Bank 66
	Configuration	HP I/O Bank 65
	HD I/O Bank 44	HP I/O Bank 64

X15591-062217

Figure 1-75: XCKU9P Banks

GTH Quad 130 X0Y12-X0Y15 G [L]	HD I/O Bank 50	GTH Quad 230 X1Y12-X1Y15 C [R]
GTH Quad 129 X0Y8-X0Y11 F [L]	HD I/O Bank 49 O	GTH Quad 229 X1Y8-X1Y11 B [R]
GTH Quad 128 X0Y4-X0Y7 E [L] (RCAL)	HD I/O Bank 48 N	GTH Quad 228 X1Y4-X1Y7 A [R] (RCAL)
GTH Quad 127 X0Y0-X0Y3 D [L]	HD I/O Bank 47 G	HP I/O Bank 67 E
	SYSMON Configuration	HP I/O Bank 66 D
	Configuration	HP I/O Bank 65 C
	HD I/O Bank 44 F	HP I/O Bank 64 B

X15592-062217

Figure 1-76: XCKU9P Banks in FFVE900 Package

XCKU11P Bank Diagrams

GTY Quad 131 X0Y16-X0Y19	PCIE4 X0Y3	HP I/O Bank 71	HD I/O Bank 91	GTH Quad 231 X0Y28-X0Y31
GTY Quad 130 X0Y12-X0Y15	CMAC X0Y1	HP I/O Bank 70	HD I/O Bank 90	GTH Quad 230 X0Y24-X0Y27
GTY Quad 129 X0Y8-X0Y11 (RCAL)	ILKN X0Y0	HP I/O Bank 69	HD I/O Bank 89	GTH Quad 229 X0Y20-X0Y23
GTY Quad 128 X0Y4-X0Y7	PCIE4 X0Y2	HP I/O Bank 68	HD I/O Bank 88	GTH Quad 228 X0Y16-X0Y19
GTY Quad 127 X0Y0-X0Y3	CMAC X0Y0	HP I/O Bank 67	PCIE4 X1Y1	GTH Quad 227 X0Y12-X0Y15
		HP I/O Bank 66	SYSMON Configuration	GTH Quad 226 X0Y8-X0Y11 (RCAL)
		HP I/O Bank 65	Configuration	GTH Quad 225 X0Y4-X0Y7
		HP I/O Bank 64	PCIE4 X1Y0 (tandem)	GTH Quad 224 X0Y0-X0Y3

X15593-020817

Figure 1-77: XCKU11P Banks

GTY Quad 131 X0Y16-X0Y19	PCIE4 X0Y3	HP I/O Bank 71	HD I/O Bank 91 K	GTH Quad 231 X0Y28-X0Y31
GTY Quad 130 X0Y12-X0Y15	CMAC X0Y1	HP I/O Bank 70 H	HD I/O Bank 90 L	GTH Quad 230 X0Y24-X0Y27
GTY Quad 129 X0Y8-X0Y11 (RCAL)	ILKN X0Y0	HP I/O Bank 69 G	HD I/O Bank 89 J	GTH Quad 229 X0Y20-X0Y23
GTY Quad 128 X0Y4-X0Y7	PCIE4 X0Y2	HP I/O Bank 68 F	HD I/O Bank 88 I	GTH Quad 228 X0Y16-X0Y19
GTY Quad 127 X0Y0-X0Y3	CMAC X0Y0	HP I/O Bank 67 E	PCIE4 X1Y1	GTH Quad 227 X0Y12-X0Y15 D [R]
		HP I/O Bank 66 D	SYSMON Configuration	GTH Quad 226 X0Y8-X0Y11 C [R] (RCAL)
		HP I/O Bank 65 C	Configuration	GTH Quad 225 X0Y4-X0Y7 B [R]
		HP I/O Bank 64	PCIE4 X1Y0 (tandem)	GTH Quad 224 X0Y0-X0Y3 A [R]

X15594-020817

Figure 1-78: XCKU11P Banks in FFVD900 Package

GTU Quad 131 X0Y16-X0Y19	PCIE4 X0Y3	HP I/O Bank 71 F	HD I/O Bank 91	GTH Quad 231 X0Y28-X0Y31
GTU Quad 130 X0Y12-X0Y15 G[L]	CMAC X0Y1	HP I/O Bank 70 E	HD I/O Bank 90	GTH Quad 230 X0Y24-X0Y27
GTU Quad 129 X0Y8-X0Y11 F [L] (RCAL)	ILKN X0Y0	HP I/O Bank 69 K	HD I/O Bank 89 R	GTH Quad 229 X0Y20-X0Y23
GTU Quad 128 X0Y4-X0Y7	PCIE4 X0Y2	HP I/O Bank 68 J	HD I/O Bank 88 R	GTH Quad 228 X0Y16-X0Y19 E [R]
GTU Quad 127 X0Y0-X0Y3	CMAC X0Y0	HP I/O Bank 67 G	PCIE4 X1Y1	GTH Quad 227 X0Y12-X0Y15 D [R]
		HP I/O Bank 66 D	SYSMON Configuration	GTH Quad 226 X0Y8-X0Y11 C [R] (RCAL)
		HP I/O Bank 65 C	Configuration	GTH Quad 225 X0Y4-X0Y7 B [R]
		HP I/O Bank 64 H	PCIE4 X1Y0 (tandem)	GTH Quad 224 X0Y0-X0Y3 A [R]

X15595-062217

Figure 1-79: XCKU11P Banks in FFVA1156 Package

GTY Quad 131 X0Y16-X0Y19 M [L]	PCIE4 X0Y3	HP I/O Bank 71 R	HD I/O Bank 91 N	GTH Quad 231 X0Y28-X0Y31 H [RN]
GTY Quad 130 X0Y12-X0Y15 L [L]	CMAC X0Y1	HP I/O Bank 70 S	HD I/O Bank 90 O	GTH Quad 230 X0Y24-X0Y27 G [RN]
GTY Quad 129 X0Y8-X0Y11 K [L] (RCAL)	ILKN X0Y0	HP I/O Bank 69 T	HD I/O Bank 89 P	GTH Quad 229 X0Y20-X0Y23 F [RN]
GTY Quad 128 X0Y4-X0Y7 J [L]	PCIE4 X0Y2	HP I/O Bank 68 G	HD I/O Bank 88 Q	GTH Quad 228 X0Y16-X0Y19 E [RN]
GTY Quad 127 X0Y0-X0Y3 I [L]	CMAC X0Y0	HP I/O Bank 67 F	PCIE4 X1Y1	GTH Quad 227 X0Y12-X0Y15 D [RS]
		HP I/O Bank 66 E	SYSMON Configuration	GTH Quad 226 X0Y8-X0Y11 C [RS] (RCAL)
		HP I/O Bank 65 C	Configuration	GTH Quad 225 X0Y4-X0Y7 B [RS]
		HP I/O Bank 64 D	PCIE4 X1Y0 (tandem)	GTH Quad 224 X0Y0-X0Y3 A [RS]

X15597-020817

Figure 1-80: XCKU11P Banks in FFVE1517 Package

XCKU13P Bank Diagrams

GTH Quad 130 X0Y12-X0Y15	HD I/O Bank 50	GTH Quad 230 X1Y12-X1Y15
GTH Quad 129 X0Y8-X0Y11	HD I/O Bank 49	GTH Quad 229 X1Y8-X1Y11
GTH Quad 128 X0Y4-X0Y7 (RCAL)	HD I/O Bank 48	GTH Quad 228 X1Y4-X1Y7 (RCAL)
GTH Quad 127 X0Y0-X0Y3	HD I/O Bank 47	HP I/O Bank 67
	SYSMON Configuration	HP I/O Bank 66
	Configuration	HP I/O Bank 65
	HD I/O Bank 44	HP I/O Bank 64

X15598-062217

Figure 1-81: XCKU13P Banks

GTH Quad 130 X0Y12-X0Y15 G [L]	HD I/O Bank 50	GTH Quad 230 X1Y12-X1Y15 C [R]
GTH Quad 129 X0Y8-X0Y11 F [L]	HD I/O Bank 49 O	GTH Quad 229 X1Y8-X1Y11 B [R]
GTH Quad 128 X0Y4-X0Y7 E [L] (RCAL)	HD I/O Bank 48 N	GTH Quad 228 X1Y4-X1Y7 A [R] (RCAL)
GTH Quad 127 X0Y0-X0Y3 D [L]	HD I/O Bank 47 G	HP I/O Bank 67 E
	SYSMON Configuration	HP I/O Bank 66 D
	Configuration	HP I/O Bank 65 C
	HD I/O Bank 44 F	HP I/O Bank 64 B

X15599-062217

Figure 1-82: XCKU13P Banks in FFVE900 Package

XCKU15P and XQKU15P Bank Diagrams

GTY Quad 134 X0Y28-X0Y31	CMAC X0Y3	HP I/O Bank 74	HD I/O Bank 94	GTH Quad 234 X0Y40-X0Y43
GTY Quad 133 X0Y24-X0Y27	ILKN X0Y2	HP I/O Bank 73	HD I/O Bank 93	GTH Quad 233 X0Y36-X0Y39
GTY Quad 132 X0Y20-X0Y23	CMAC X0Y2	HP I/O Bank 72	ILKN X1Y1	GTH Quad 232 X0Y32-X0Y35
GTY Quad 131 X0Y16-X0Y19	PCIE4 X0Y3	HP I/O Bank 71	HD I/O Bank 91	GTH Quad 231 X0Y28-X0Y31
GTY Quad 130 X0Y12-X0Y15	CMAC X0Y1	HP I/O Bank 70	HD I/O Bank 90	GTH Quad 230 X0Y24-X0Y27
GTY Quad 129 X0Y8-X0Y11 (RCAL)	ILKN X0Y0	HP I/O Bank 69	ILKN X1Y0	GTH Quad 229 X0Y20-X0Y23
GTY Quad 128 X0Y4-X0Y7	PCIE4 X0Y2	HP I/O Bank 68	PCIE4 X1Y2	GTH Quad 228 X0Y16-X0Y19
GTY Quad 127 X0Y0-X0Y3	CMAC X0Y0	HP I/O Bank 67	PCIE4 X1Y1	GTH Quad 227 X0Y12-X0Y15
		HP I/O Bank 66	SYSMON Configuration	GTH Quad 226 X0Y8-X0Y11 (RCAL)
		HP I/O Bank 65	Configuration	GTH Quad 225 X0Y4-X0Y7
		HP I/O Bank 64	PCIE4 X1Y0 (tandem)	GTH Quad 224 X0Y0-X0Y3

X15600-062217

Figure 1-83: XCKU15P and XQKU15P Banks

GTU Quad 134 X0Y28-X0Y31	CMAC X0Y3	HP I/O Bank 74	HD I/O Bank 94	GTH Quad 234 X0Y40-X0Y43
GTU Quad 133 X0Y24-X0Y27	ILKN X0Y2	HP I/O Bank 73	HD I/O Bank 93	GTH Quad 233 X0Y36-X0Y39
GTU Quad 132 X0Y20-X0Y23	CMAC X0Y2	HP I/O Bank 72 F	ILKN X1Y1	GTH Quad 232 X0Y32-X0Y35
GTU Quad 131 X0Y16-X0Y19	PCIE4 X0Y3	HP I/O Bank 71 E	HD I/O Bank 91 R	GTH Quad 231 X0Y28-X0Y31
GTU Quad 130 X0Y12-X0Y15 G[L]	CMAC X0Y1	HP I/O Bank 70 K	HD I/O Bank 90 R	GTH Quad 230 X0Y24-X0Y27
GTU Quad 129 X0Y8-X0Y11 F[L] (RCAL)	ILKN X0Y0	HP I/O Bank 69 J	ILKN X1Y0	GTH Quad 229 X0Y20-X0Y23
GTU Quad 128 X0Y4-X0Y7	PCIE4 X0Y2	HP I/O Bank 68 I	PCIE4 X1Y2	GTH Quad 228 X0Y16-X0Y19 E [R]
GTU Quad 127 X0Y0-X0Y3	CMAC X0Y0	HP I/O Bank 67 G	PCIE4 X1Y1	GTH Quad 227 X0Y12-X0Y15 D [R]
		HP I/O Bank 66 D	SYSMON Configuration	GTH Quad 226 X0Y8-X0Y11 C [R] (RCAL)
		HP I/O Bank 65 C	Configuration	GTH Quad 225 X0Y4-X0Y7 B [R]
		HP I/O Bank 64 H	PCIE4 X1Y0 (tandem)	GTH Quad 224 X0Y0-X0Y3 A [R]

X15601-062217

Figure 1-84: XCKU15P Banks in FFVA1156 Package and XQKU15P in FFRA1156 Package

GTY Quad 134 X0Y28-X0Y31	CMAC X0Y3	HP I/O Bank 74	HD I/O Bank 94 N	GTH Quad 234 X0Y40-X0Y43
GTY Quad 133 X0Y24-X0Y27	ILKN X0Y2	HP I/O Bank 73	HD I/O Bank 93 O	GTH Quad 233 X0Y36-X0Y39
GTY Quad 132 X0Y20-X0Y23 N [L]	CMAC X0Y2	HP I/O Bank 72	ILKN X1Y1	GTH Quad 232 X0Y32-X0Y35
GTY Quad 131 X0Y16-X0Y19 M [L]	PCIE4 X0Y3	HP I/O Bank 71 R	HD I/O Bank 91 P	GTH Quad 231 X0Y28-X0Y31 H [RN]
GTY Quad 130 X0Y12-X0Y15 L [L]	CMAC X0Y1	HP I/O Bank 70 S	HD I/O Bank 90 Q	GTH Quad 230 X0Y24-X0Y27 G [RN]
GTY Quad 129 X0Y8-X0Y11 K [L] (RCAL)	ILKN X0Y0	HP I/O Bank 69 T	ILKN X1Y0	GTH Quad 229 X0Y20-X0Y23 F [RN]
GTY Quad 128 X0Y4-X0Y7 J [L]	PCIE4 X0Y2	HP I/O Bank 68 G	PCIE4 X1Y2	GTH Quad 228 X0Y16-X0Y19 E [RN]
GTY Quad 127 X0Y0-X0Y3 I [L]	CMAC X0Y0	HP I/O Bank 67 F	PCIE4 X1Y1	GTH Quad 227 X0Y12-X0Y15 D [RS]
		HP I/O Bank 66 E	SYSMON Configuration	GTH Quad 226 X0Y8-X0Y11 C [RS] (RCAL)
		HP I/O Bank 65 C	Configuration	GTH Quad 225 X0Y4-X0Y7 B [RS]
		HP I/O Bank 64 D	PCIE4 X1Y0 (tandem)	GTH Quad 224 X0Y0-X0Y3 A [RS]

X15602-062217

Figure 1-85: XCKU15P Banks in FFVE1517 Package and XQKU15P Banks in FFRE1517 Package

GTU Quad 134 X0Y28-X0Y31 S [LN]	CMAC X0Y3	HP I/O Bank 74	HD I/O Bank 94 N	GTH Quad 234 X0Y40-X0Y43 K [RN]
GTU Quad 133 X0Y24-X0Y27 R [LN]	ILKN X0Y2	HP I/O Bank 73	HD I/O Bank 93 O	GTH Quad 233 X0Y36-X0Y39 J [RN]
GTU Quad 132 X0Y20-X0Y23 Q [LN]	CMAC X0Y2	HP I/O Bank 72 R	ILKN X1Y1	GTH Quad 232 X0Y32-X0Y35 I [RN]
GTU Quad 131 X0Y16-X0Y19 P [LN]	PCIE4 X0Y3	HP I/O Bank 71 S	HD I/O Bank 91 P	GTH Quad 231 X0Y28-X0Y31 H [RN]
GTU Quad 130 X0Y12-X0Y15 O [LS]	CMAC X0Y1	HP I/O Bank 70 T	HD I/O Bank 90 Q	GTH Quad 230 X0Y24-X0Y27 G [RN]
GTU Quad 129 X0Y8-X0Y11 N [LS] (RCAL)	ILKN X0Y0	HP I/O Bank 69	ILKN X1Y0	GTH Quad 229 X0Y20-X0Y23 F [RS]
GTU Quad 128 X0Y4-X0Y7 M [LS]	PCIE4 X0Y2	HP I/O Bank 68 G	PCIE4 X1Y2	GTH Quad 228 X0Y16-X0Y19 E [RS]
GTU Quad 127 X0Y0-X0Y3 L [LS]	CMAC X0Y0	HP I/O Bank 67 F	PCIE4 X1Y1	GTH Quad 227 X0Y12-X0Y15 D [RS]
		HP I/O Bank 66 E	SYSMON Configuration	GTH Quad 226 X0Y8-X0Y11 C [RS] (RCAL)
		HP I/O Bank 65 C	Configuration	GTH Quad 225 X0Y4-X0Y7 B [RS]
		HP I/O Bank 64 D	PCIE4 X1Y0 (tandem)	GTH Quad 224 X0Y0-X0Y3 A [RS]

X15604-062217

Figure 1-86: XCKU15P Banks in FFVA1760 Package

GTY Quad 134 X0Y28-X0Y31	CMAC X0Y3	HP I/O Bank 74 R	HD I/O Bank 94 N	GTH Quad 234 X0Y40-X0Y43
GTY Quad 133 X0Y24-X0Y27	ILKN X0Y2	HP I/O Bank 73 S	HD I/O Bank 93 O	GTH Quad 233 X0Y36-X0Y39
GTY Quad 132 X0Y20-X0Y23 N [L]	CMAC X0Y2	HP I/O Bank 72 T	ILKN X1Y1	GTH Quad 232 X0Y32-X0Y35
GTY Quad 131 X0Y16-X0Y19 M [L]	PCIE4 X0Y3	HP I/O Bank 71 U	HD I/O Bank 91 P	GTH Quad 231 X0Y28-X0Y31 H [RN]
GTY Quad 130 X0Y12-X0Y15 L [L]	CMAC X0Y1	HP I/O Bank 70 V	HD I/O Bank 90 Q	GTH Quad 230 X0Y24-X0Y27 G [RN]
GTY Quad 129 X0Y8-X0Y11 K [L] (RCAL)	ILKN X0Y0	HP I/O Bank 69 H	ILKN X1Y0	GTH Quad 229 X0Y20-X0Y23 F [RN]
GTY Quad 128 X0Y4-X0Y7 J [L]	PCIE4 X0Y2	HP I/O Bank 68 G	PCIE4 X1Y2	GTH Quad 228 X0Y16-X0Y19 E [RN]
GTY Quad 127 X0Y0-X0Y3 I [L]	CMAC X0Y0	HP I/O Bank 67 F	PCIE4 X1Y1	GTH Quad 227 X0Y12-X0Y15 D [RS]
		HP I/O Bank 66 E	SYSMON Configuration	GTH Quad 226 X0Y8-X0Y11 C [RS] (RCAL)
		HP I/O Bank 65 C	Configuration	GTH Quad 225 X0Y4-X0Y7 B [RS]
		HP I/O Bank 64 D	PCIE4 X1Y0 (tandem)	GTH Quad 224 X0Y0-X0Y3 A [RS]

X15603-062217

Figure 1-87: XCKU15P Banks in FFVE1760 Package

XCVU3P and XQVU3P Bank Diagrams

GTY Quad 128 X0Y16-X0Y19	CMAC X0Y2	HP I/O Bank 48	HP I/O Bank 68	ILKN X1Y2	GTY Quad 228 X1Y16-X1Y19
GTY Quad 127 X0Y12-X0Y15	PCIE4 X0Y1	HP I/O Bank 47	HP I/O Bank 67	ILKN X1Y1	GTY Quad 227 X1Y12-X1Y15
GTY Quad 126 X0Y8-X0Y11 (RCAL)	CMAC X0Y1	HP I/O Bank 46	HP I/O Bank 66	SYSMON Configuration	GTY Quad 226 X1Y8-X1Y11 (RCAL)
GTY Quad 125 X0Y4-X0Y7	ILKN X0Y0	HP I/O Bank 45	HP I/O Bank 65	Configuration	GTY Quad 225 X1Y4-X1Y7
GTY Quad 124 X0Y0-X0Y3	CMAC X0Y0	HP I/O Bank 44	HP I/O Bank 64	PCIE4 X1Y0 (tandem)	GTY Quad 224 X1Y0-X1Y3

X15605-020817

Figure 1-88: XCVU3P and XQVU3P Banks

GTY Quad 128 X0Y16-X0Y19 J [L]	CMAC X0Y2	HP I/O Bank 48 K	HP I/O Bank 68 F	ILKN X1Y2	GTY Quad 228 X1Y16-X1Y19 E [R]
GTY Quad 127 X0Y12-X0Y15 I [L]	PCIE4 X0Y1	HP I/O Bank 47 J	HP I/O Bank 67 E	ILKN X1Y1	GTY Quad 227 X1Y12-X1Y15 D [R]
GTY Quad 126 X0Y8-X0Y11 H [L] (RCAL)	CMAC X0Y1	HP I/O Bank 46 I	HP I/O Bank 66 D	SYSMON Configuration	GTY Quad 226 X1Y8-X1Y11 C [R] (RCAL)
GTY Quad 125 X0Y4-X0Y7 G [L]	ILKN X0Y0	HP I/O Bank 45 H	HP I/O Bank 65 C	Configuration	GTY Quad 225 X1Y4-X1Y7 B [R]
GTY Quad 124 X0Y0-X0Y3 F [L]	CMAC X0Y0	HP I/O Bank 44 G	HP I/O Bank 64 B	PCIE4 X1Y0 (tandem)	GTY Quad 224 X1Y0-X1Y3 A [R]

X15606-020817

Figure 1-89: XCVU3P Banks in FFVC1517 Package and XQVU3P Banks in FFRC1517 Package

XCVU5P Bank Diagrams

GTY Quad 133 X0Y36-X0Y39	CMAC X0Y5	HP I/O Bank 53	HP I/O Bank 73	ILKN X1Y5	GTY Quad 233 X1Y36-X1Y39
GTY Quad 132 X0Y32-X0Y35	PCIE4 X0Y3	HP I/O Bank 52	HP I/O Bank 72	ILKN X1Y4	GTY Quad 232 X1Y32-X1Y35
GTY Quad 131 X0Y28-X0Y31 (RCAL)	CMAC X0Y4	HP I/O Bank 51	HP I/O Bank 71	SYSMON Configuration	GTY Quad 231 X1Y28-X1Y31 (RCAL)
GTY Quad 130 X0Y24-X0Y27	ILKN X0Y3	HP I/O Bank 50	HP I/O Bank 70	Configuration	GTY Quad 230 X1Y24-X1Y27
GTY Quad 129 X0Y20-X0Y23	CMAC X0Y3	HP I/O Bank 49	HP I/O Bank 69	PCIE4 X1Y2	GTY Quad 229 X1Y20-X1Y23
SLR Crossing					
GTY Quad 128 X0Y16-X0Y19	CMAC X0Y2	HP I/O Bank 48	HP I/O Bank 68	ILKN X1Y2	GTY Quad 228 X1Y16-X1Y19
GTY Quad 127 X0Y12-X0Y15	PCIE4 X0Y1	HP I/O Bank 47	HP I/O Bank 67	ILKN X1Y1	GTY Quad 227 X1Y12-X1Y15
GTY Quad 126 X0Y8-X0Y11 (RCAL)	CMAC X0Y1	HP I/O Bank 46	HP I/O Bank 66	SYSMON Configuration	GTY Quad 226 X1Y8-X1Y11 (RCAL)
GTY Quad 125 X0Y4-X0Y7	ILKN X0Y0	HP I/O Bank 45	HP I/O Bank 65	Configuration	GTY Quad 225 X1Y4-X1Y7
GTY Quad 124 X0Y0-X0Y3	CMAC X0Y0	HP I/O Bank 44	HP I/O Bank 64	PCIE4 X1Y0 (tandem)	GTY Quad 224 X1Y0-X1Y3

X18708-020817

Figure 1-90: XCVU5P Banks

GTY Quad 133 X0Y36-X0Y39	CMAC X0Y5	HP I/O Bank 53 M	HP I/O Bank 73 Q	ILKN X1Y5	GTY Quad 233 X1Y36-X1Y39 G [RN]
GTY Quad 132 X0Y32-X0Y35 M [LN]	PCIE4 X0Y3	HP I/O Bank 52 L	HP I/O Bank 72 P	ILKN X1Y4	GTY Quad 232 X1Y32-X1Y35 F [RN]
GTY Quad 131 X0Y28-X0Y31 L [LN] (RCAL)	CMAC X0Y4	HP I/O Bank 51 K	HP I/O Bank 71 O	SYSMON Configuration	GTY Quad 231 X1Y28-X1Y31 E [RN] (RCAL)
GTY Quad 130 X0Y24-X0Y27 K [LN]	ILKN X0Y3	HP I/O Bank 50 J	HP I/O Bank 70 N	Configuration	GTY Quad 230 X1Y24-X1Y27
GTY Quad 129 X0Y20-X0Y23	CMAC X0Y3	HP I/O Bank 49	HP I/O Bank 69	PCIE4 X1Y2	GTY Quad 229 X1Y20-X1Y23
SLR Crossing					
GTY Quad 128 X0Y16-X0Y19	CMAC X0Y2	HP I/O Bank 48	HP I/O Bank 68	ILKN X1Y2	GTY Quad 228 X1Y16-X1Y19
GTY Quad 127 X0Y12-X0Y15 J [LS]	PCIE4 X0Y1	HP I/O Bank 47 I	HP I/O Bank 67 E	ILKN X1Y1	GTY Quad 227 X1Y12-X1Y15 D [RS]
GTY Quad 126 X0Y8-X0Y11 I [LS] (RCAL)	CMAC X0Y1	HP I/O Bank 46 H	HP I/O Bank 66 D	SYSMON Configuration	GTY Quad 226 X1Y8-X1Y11 C [RS] (RCAL)
GTY Quad 125 X0Y4-X0Y7 H [LS]	ILKN X0Y0	HP I/O Bank 45 G	HP I/O Bank 65 C	Configuration	GTY Quad 225 X1Y4-X1Y7 B [RS]
GTY Quad 124 X0Y0-X0Y3	CMAC X0Y0	HP I/O Bank 44 F	HP I/O Bank 64 B	PCIE4 X1Y0 (tandem)	GTY Quad 224 X1Y0-X1Y3 A [RS]

X18709-020817

Figure 1-91: XCVU5P Banks in FLVA2104 Package

GTY Quad 133 X0Y36-X0Y39 S [LN]	CMAC X0Y5	HP I/O Bank 53	HP I/O Bank 73	ILKN X1Y5	GTY Quad 233 X1Y36-X1Y39 J [RN]
GTY Quad 132 X0Y32-X0Y35 R [LN]	PCIE4 X0Y3	HP I/O Bank 52 L	HP I/O Bank 72 O	ILKN X1Y4	GTY Quad 232 X1Y32-X1Y35 I [RN]
GTY Quad 131 X0Y28-X0Y31 Q [LN] (RCAL)	CMAC X0Y4	HP I/O Bank 51 K	HP I/O Bank 71 N	SYSMON Configuration	GTY Quad 231 X1Y28-X1Y31 H [RN] (RCAL)
GTY Quad 130 X0Y24-X0Y27 P [LN]	ILKN X0Y3	HP I/O Bank 50 J	HP I/O Bank 70 M	Configuration	GTY Quad 230 X1Y24-X1Y27 G [RN]
GTY Quad 129 X0Y20-X0Y23 O [LN]	CMAC X0Y3	HP I/O Bank 49	HP I/O Bank 69	PCIE4 X1Y2	GTY Quad 229 X1Y20-X1Y23 F [RN]
SLR Crossing					
GTY Quad 128 X0Y16-X0Y19 N [LS]	CMAC X0Y2	HP I/O Bank 48	HP I/O Bank 68 F (Partial)	ILKN X1Y2	GTY Quad 228 X1Y16-X1Y19 E [RS]
GTY Quad 127 X0Y12-X0Y15 M [LS]	PCIE4 X0Y1	HP I/O Bank 47	HP I/O Bank 67 E	ILKN X1Y1	GTY Quad 227 X1Y12-X1Y15 D [RS]
GTY Quad 126 X0Y8-X0Y11 L [LS] (RCAL)	CMAC X0Y1	HP I/O Bank 46 I	HP I/O Bank 66 D	SYSMON Configuration	GTY Quad 226 X1Y8-X1Y11 C [RS] (RCAL)
GTY Quad 125 X0Y4-X0Y7 K [LS]	ILKN X0Y0	HP I/O Bank 45 H	HP I/O Bank 65 C	Configuration	GTY Quad 225 X1Y4-X1Y7 B [RS]
GTY Quad 124 X0Y0-X0Y3	CMAC X0Y0	HP I/O Bank 44 G	HP I/O Bank 64 B	PCIE4 X1Y0 (tandem)	GTY Quad 224 X1Y0-X1Y3 A [RS]

X16504-020817

Figure 1-92: XCVU5P Banks in FLVB2104 Package

GTY Quad 133 X0Y36-X0Y39 W [LN]	CMAC X0Y5	HP I/O Bank 53	HP I/O Bank 73	ILKN X1Y5	GTY Quad 233 X1Y36-X1Y39 J [RN]
GTY Quad 132 X0Y32-X0Y35 V [LN]	PCIE4 X0Y3	HP I/O Bank 52	HP I/O Bank 72 I	ILKN X1Y4	GTY Quad 232 X1Y32-X1Y35 I [RN]
GTY Quad 131 X0Y28-X0Y31 U [LN] (RCAL)	CMAC X0Y4	HP I/O Bank 51	HP I/O Bank 71 H	SYSMON Configuration	GTY Quad 231 X1Y28-X1Y31 H [RN] (RCAL)
GTY Quad 130 X0Y24-X0Y27 T [LN]	ILKN X0Y3	HP I/O Bank 50	HP I/O Bank 70 G	Configuration	GTY Quad 230 X1Y24-X1Y27 G [RN]
GTY Quad 129 X0Y20-X0Y23 S [LN]	CMAC X0Y3	HP I/O Bank 49	HP I/O Bank 69	PCIE4 X1Y2	GTY Quad 229 X1Y20-X1Y23 F [RN]
SLR Crossing					
GTY Quad 128 X0Y16-X0Y19 R [LC]	CMAC X0Y2	HP I/O Bank 48	HP I/O Bank 68 F	ILKN X1Y2	GTY Quad 228 X1Y16-X1Y19 E [RC]
GTY Quad 127 X0Y12-X0Y15 Q [LC]	PCIE4 X0Y1	HP I/O Bank 47	HP I/O Bank 67 E	ILKN X1Y1	GTY Quad 227 X1Y12-X1Y15 D [RC]
GTY Quad 126 X0Y8-X0Y11 P [LC] (RCAL)	CMAC X0Y1	HP I/O Bank 46	HP I/O Bank 66 D	SYSMON Configuration	GTY Quad 226 X1Y8-X1Y11 C [RC] (RCAL)
GTY Quad 125 X0Y4-X0Y7 O [LC]	ILKN X0Y0	HP I/O Bank 45	HP I/O Bank 65 C	Configuration	GTY Quad 225 X1Y4-X1Y7 B [RC]
GTY Quad 124 X0Y0-X0Y3 N [LC]	CMAC X0Y0	HP I/O Bank 44	HP I/O Bank 64 B	PCIE4 X1Y0 (tandem)	GTY Quad 224 X1Y0-X1Y3 A [RC]

X16505-020817

Figure 1-93: XCVU5P Banks in FLVC2104 Package

XCVU7P and XQVU7P Bank Diagrams

GTY Quad 133 X0Y36-X0Y39	CMAC X0Y5	HP I/O Bank 53	HP I/O Bank 73	ILKN X1Y5	GTY Quad 233 X1Y36-X1Y39
GTY Quad 132 X0Y32-X0Y35	PCIE4 X0Y3	HP I/O Bank 52	HP I/O Bank 72	ILKN X1Y4	GTY Quad 232 X1Y32-X1Y35
GTY Quad 131 X0Y28-X0Y31 (RCAL)	CMAC X0Y4	HP I/O Bank 51	HP I/O Bank 71	SYSMON Configuration	GTY Quad 231 X1Y28-X1Y31 (RCAL)
GTY Quad 130 X0Y24-X0Y27	ILKN X0Y3	HP I/O Bank 50	HP I/O Bank 70	Configuration	GTY Quad 230 X1Y24-X1Y27
GTY Quad 129 X0Y20-X0Y23	CMAC X0Y3	HP I/O Bank 49	HP I/O Bank 69	PCIE4 X1Y2	GTY Quad 229 X1Y20-X1Y23
SLR Crossing					
GTY Quad 128 X0Y16-X0Y19	CMAC X0Y2	HP I/O Bank 48	HP I/O Bank 68	ILKN X1Y2	GTY Quad 228 X1Y16-X1Y19
GTY Quad 127 X0Y12-X0Y15	PCIE4 X0Y1	HP I/O Bank 47	HP I/O Bank 67	ILKN X1Y1	GTY Quad 227 X1Y12-X1Y15
GTY Quad 126 X0Y8-X0Y11 (RCAL)	CMAC X0Y1	HP I/O Bank 46	HP I/O Bank 66	SYSMON Configuration	GTY Quad 226 X1Y8-X1Y11 (RCAL)
GTY Quad 125 X0Y4-X0Y7	ILKN X0Y0	HP I/O Bank 45	HP I/O Bank 65	Configuration	GTY Quad 225 X1Y4-X1Y7
GTY Quad 124 X0Y0-X0Y3	CMAC X0Y0	HP I/O Bank 44	HP I/O Bank 64	PCIE4 X1Y0 (tandem)	GTY Quad 224 X1Y0-X1Y3

X15607-020817

Figure 1-94: XCVU7P and XQVU7P Banks

GTY Quad 133 X0Y36-X0Y39	CMAC X0Y5	HP I/O Bank 53 M	HP I/O Bank 73 Q	ILKN X1Y5	GTY Quad 233 X1Y36-X1Y39 G [RN]
GTY Quad 132 X0Y32-X0Y35 M [LN]	PCIE4 X0Y3	HP I/O Bank 52 L	HP I/O Bank 72 P	ILKN X1Y4	GTY Quad 232 X1Y32-X1Y35 F [RN]
GTY Quad 131 X0Y28-X0Y31 L [LN] (RCAL)	CMAC X0Y4	HP I/O Bank 51 K	HP I/O Bank 71 O	SYSMON Configuration	GTY Quad 231 X1Y28-X1Y31 E [RN] (RCAL)
GTY Quad 130 X0Y24-X0Y27 K [LN]	ILKN X0Y3	HP I/O Bank 50 J	HP I/O Bank 70 N	Configuration	GTY Quad 230 X1Y24-X1Y27
GTY Quad 129 X0Y20-X0Y23	CMAC X0Y3	HP I/O Bank 49	HP I/O Bank 69	PCIE4 X1Y2	GTY Quad 229 X1Y20-X1Y23
SLR Crossing					
GTY Quad 128 X0Y16-X0Y19	CMAC X0Y2	HP I/O Bank 48	HP I/O Bank 68	ILKN X1Y2	GTY Quad 228 X1Y16-X1Y19
GTY Quad 127 X0Y12-X0Y15 J [LS]	PCIE4 X0Y1	HP I/O Bank 47 I	HP I/O Bank 67 E	ILKN X1Y1	GTY Quad 227 X1Y12-X1Y15 D [RS]
GTY Quad 126 X0Y8-X0Y11 I [LS] (RCAL)	CMAC X0Y1	HP I/O Bank 46 H	HP I/O Bank 66 D	SYSMON Configuration	GTY Quad 226 X1Y8-X1Y11 C [RS] (RCAL)
GTY Quad 125 X0Y4-X0Y7 H [LS]	ILKN X0Y0	HP I/O Bank 45 G	HP I/O Bank 65 C	Configuration	GTY Quad 225 X1Y4-X1Y7 B [RS]
GTY Quad 124 X0Y0-X0Y3	CMAC X0Y0	HP I/O Bank 44 F	HP I/O Bank 64 B	PCIE4 X1Y0 (tandem)	GTY Quad 224 X1Y0-X1Y3 A [RS]

X15608-020817

Figure 1-95: XCVU7P Banks in FLVA2104 Package and XQVU7P in FLRA2104 Package

GTY Quad 133 X0Y36-X0Y39 S [LN]	CMAC X0Y5	HP I/O Bank 53	HP I/O Bank 73	ILKN X1Y5	GTY Quad 233 X1Y36-X1Y39 J [RN]
GTY Quad 132 X0Y32-X0Y35 R [LN]	PCIE4 X0Y3	HP I/O Bank 52 L	HP I/O Bank 72 O	ILKN X1Y4	GTY Quad 232 X1Y32-X1Y35 I [RN]
GTY Quad 131 X0Y28-X0Y31 Q [LN] (RCAL)	CMAC X0Y4	HP I/O Bank 51 K	HP I/O Bank 71 N	SYSMON Configuration	GTY Quad 231 X1Y28-X1Y31 H [RN] (RCAL)
GTY Quad 130 X0Y24-X0Y27 P [LN]	ILKN X0Y3	HP I/O Bank 50 J	HP I/O Bank 70 M	Configuration	GTY Quad 230 X1Y24-X1Y27 G [RN]
GTY Quad 129 X0Y20-X0Y23 O [LN]	CMAC X0Y3	HP I/O Bank 49	HP I/O Bank 69	PCIE4 X1Y2	GTY Quad 229 X1Y20-X1Y23 F [RN]
SLR Crossing					
GTY Quad 128 X0Y16-X0Y19 N [LS]	CMAC X0Y2	HP I/O Bank 48	HP I/O Bank 68 F (Partial)	ILKN X1Y2	GTY Quad 228 X1Y16-X1Y19 E [RS]
GTY Quad 127 X0Y12-X0Y15 M [LS]	PCIE4 X0Y1	HP I/O Bank 47	HP I/O Bank 67 E	ILKN X1Y1	GTY Quad 227 X1Y12-X1Y15 D [RS]
GTY Quad 126 X0Y08-X0Y11 L [LS] (RCAL)	CMAC X0Y1	HP I/O Bank 46 I	HP I/O Bank 66 D	SYSMON Configuration	GTY Quad 226 X1Y8-X1Y11 C [RS] (RCAL)
GTY Quad 125 X0Y4-X0Y7 K [LS]	ILKN X0Y0	HP I/O Bank 45 H	HP I/O Bank 65 C	Configuration	GTY Quad 225 X1Y4-X1Y7 B [RS]
GTY Quad 124 X0Y0-X0Y3	CMAC X0Y0	HP I/O Bank 44 G	HP I/O Bank 64 B	PCIE4 X1Y0 (tandem)	GTY Quad 224 X1Y0-X1Y3 A [RS]

X15609-020817

Figure 1-96: XCVU7P Banks in FLVB2104 Package and XQVU7P in FLRB2104 Package

GTY Quad 133 X0Y36-X0Y39 W [LN]	CMAC X0Y5	HP I/O Bank 53	HP I/O Bank 73	ILKN X1Y5	GTY Quad 233 X1Y36-X1Y39 J [RN]
GTY Quad 132 X0Y32-X0Y35 V [LN]	PCIE4 X0Y3	HP I/O Bank 52	HP I/O Bank 72 I	ILKN X1Y4	GTY Quad 232 X1Y32-X1Y35 I [RN]
GTY Quad 131 X0Y28-X0Y31 U [LN] (RCAL)	CMAC X0Y4	HP I/O Bank 51	HP I/O Bank 71 H	SYSMON Configuration	GTY Quad 231 X1Y28-X1Y31 H [RN] (RCAL)
GTY Quad 130 X0Y24-X0Y27 T [LN]	ILKN X0Y3	HP I/O Bank 50	HP I/O Bank 70 G	Configuration	GTY Quad 230 X1Y24-X1Y27 G [RN]
GTY Quad 129 X0Y20-X0Y23 S [LN]	CMAC X0Y3	HP I/O Bank 49	HP I/O Bank 69	PCIE4 X1Y2	GTY Quad 229 X1Y20-X1Y23 F [RN]
SLR Crossing					
GTY Quad 128 X0Y16-X0Y19 R [LC]	CMAC X0Y2	HP I/O Bank 48	HP I/O Bank 68 F	ILKN X1Y2	GTY Quad 228 X1Y16-X1Y19 E [RC]
GTY Quad 127 X0Y12-X0Y15 Q [LC]	PCIE4 X0Y1	HP I/O Bank 47	HP I/O Bank 67 E	ILKN X1Y1	GTY Quad 227 X1Y12-X1Y15 D [RC]
GTY Quad 126 X0Y8-X0Y11 P [LC] (RCAL)	CMAC X0Y1	HP I/O Bank 46	HP I/O Bank 66 D	SYSMON Configuration	GTY Quad 226 X1Y8-X1Y11 C [RC] (RCAL)
GTY Quad 125 X0Y4-X0Y7 O [LC]	ILKN X0Y0	HP I/O Bank 45	HP I/O Bank 65 C	Configuration	GTY Quad 225 X1Y4-X1Y7 B [RC]
GTY Quad 124 X0Y0-X0Y3 N [LC]	CMAC X0Y0	HP I/O Bank 44	HP I/O Bank 64 B	PCIE4 X1Y0 (tandem)	GTY Quad 224 X1Y0-X1Y3 A [RC]

X15610-020817

Figure 1-97: XCVU7P Banks in FLVC2104 Package

XCVU9P Bank Diagrams

GTY Quad 133 X0Y56-X0Y59	CMAC X0Y8	HP I/O Bank 53	HP I/O Bank 73	ILKN X1Y8	GTY Quad 233 X1Y56-X1Y59
GTY Quad 132 X0Y52-X0Y55	PCIE4 X0Y5	HP I/O Bank 52	HP I/O Bank 72	ILKN X1Y7	GTY Quad 232 X1Y52-X1Y55
GTY Quad 131 X0Y48-X0Y51 (RCAL)	CMAC X0Y7	HP I/O Bank 51	HP I/O Bank 71	SYSMON Configuration	GTY Quad 231 X1Y48-X1Y51 (RCAL)
GTY Quad 130 X0Y44-X0Y47	ILKN X0Y6	HP I/O Bank 50	HP I/O Bank 70	Configuration	GTY Quad 230 X1Y44-X1Y47
GTY Quad 129 X0Y40-X0Y43	CMAC X0Y6	HP I/O Bank 49	HP I/O Bank 69	PCIE4 X1Y4	GTY Quad 229 X1Y40-X1Y43
SLR Crossing					
GTY Quad 128 X0Y36-X0Y39	CMAC X0Y5	HP I/O Bank 48	HP I/O Bank 68	ILKN X1Y5	GTY Quad 228 X1Y36-X1Y39
GTY Quad 127 X0Y32-X0Y35	PCIE4 X0Y3	HP I/O Bank 47	HP I/O Bank 67	ILKN X1Y4	GTY Quad 227 X1Y32-X1Y35
GTY Quad 126 X0Y28-X0Y31 (RCAL)	CMAC X0Y4	HP I/O Bank 46	HP I/O Bank 66	SYSMON Configuration	GTY Quad 226 X1Y28-X1Y31 (RCAL)
GTY Quad 125 X0Y24-X0Y27	ILKN X0Y3	HP I/O Bank 45	HP I/O Bank 65	Configuration	GTY Quad 225 X1Y24-X1Y27
GTY Quad 124 X0Y20-X0Y23	CMAC X0Y3	HP I/O Bank 44	HP I/O Bank 64	PCIE4 X1Y2 (tandem)	GTY Quad 224 X1Y20-X1Y23
SLR Crossing					
GTY Quad 123 X0Y16-X0Y19	CMAC X0Y2	HP I/O Bank 43	HP I/O Bank 63	ILKN X1Y2	GTY Quad 223 X1Y16-X1Y19
GTY Quad 122 X0Y12-X0Y15	PCIE4 X0Y1	HP I/O Bank 42	HP I/O Bank 62	ILKN X1Y1	GTY Quad 222 X1Y12-X1Y15
GTY Quad 121 X0Y8-X0Y11 (RCAL)	CMAC X0Y1	HP I/O Bank 41	HP I/O Bank 61	SYSMON Configuration	GTY Quad 221 X1Y8-X1Y11 (RCAL)
GTY Quad 120 X0Y4-X0Y7	ILKN X0Y0	HP I/O Bank 40	HP I/O Bank 60	Configuration	GTY Quad 220 X1Y4-X1Y7
GTY Quad 119 X0Y0-X0Y3	CMAC X0Y0	HP I/O Bank 39	HP I/O Bank 59	PCIE4 X1Y0	GTY Quad 219 X1Y0-X1Y3

X15611-020817

Figure 1-98: XCVU9P Banks

GTY Quad 133 X0Y56-X0Y59	CMAC X0Y8	HP I/O Bank 53	HP I/O Bank 73 Q	ILKN X1Y8	GTY Quad 233 X1Y56-X1Y59 G [RN]
GTY Quad 132 X0Y52-X0Y55	PCIE4 X0Y5	HP I/O Bank 52	HP I/O Bank 72 P	ILKN X1Y7	GTY Quad 232 X1Y52-X1Y55 F [RN]
GTY Quad 131 X0Y48-X0Y51 (RCAL)	CMAC X0Y7	HP I/O Bank 51	HP I/O Bank 71 O	SYSMON Configuration	GTY Quad 231 X1Y48-X1Y51 E [RN] (RCAL)
GTY Quad 130 X0Y44-X0Y47	ILKN X0Y6	HP I/O Bank 50	HP I/O Bank 70 N	Configuration	GTY Quad 230 X1Y44-X1Y47
GTY Quad 129 X0Y40-X0Y43	CMAC X0Y6	HP I/O Bank 49	HP I/O Bank 69	PCIE4 X1Y4	GTY Quad 229 X1Y40-X1Y43
SLR Crossing					
GTY Quad 128 X0Y36-X0Y39	CMAC X0Y5	HP I/O Bank 48 M	HP I/O Bank 68	ILKN X1Y5	GTY Quad 228 X1Y36-X1Y39
GTY Quad 127 X0Y32-X0Y35 M [LN]	PCIE4 X0Y3	HP I/O Bank 47 L	HP I/O Bank 67 E	ILKN X1Y4	GTY Quad 227 X1Y32-X1Y35 D [RS]
GTY Quad 126 X0Y28-X0Y31 L [LN] (RCAL)	CMAC X0Y4	HP I/O Bank 46 K	HP I/O Bank 66 D	SYSMON Configuration	GTY Quad 226 X1Y28-X1Y31 C [RS] (RCAL)
GTY Quad 125 X0Y24-X0Y27 K [LN]	ILKN X0Y3	HP I/O Bank 45 J	HP I/O Bank 65 C	Configuration	GTY Quad 225 X1Y24-X1Y27 B [RS]
GTY Quad 124 X0Y20-X0Y23	CMAC X0Y3	HP I/O Bank 44	HP I/O Bank 64 B	PCIE4 X1Y2 (tandem)	GTY Quad 224 X1Y20-X1Y23 A [RS]
SLR Crossing					
GTY Quad 123 X0Y16-X0Y19	CMAC X0Y2	HP I/O Bank 43 I	HP I/O Bank 63	ILKN X1Y2	GTY Quad 223 X1Y16-X1Y19
GTY Quad 122 X0Y12-X0Y15 J [LS]	PCIE4 X0Y1	HP I/O Bank 42 H	HP I/O Bank 62	ILKN X1Y1	GTY Quad 222 X1Y12-X1Y15
GTY Quad 121 X0Y8-X0Y11 I [LS] (RCAL)	CMAC X0Y1	HP I/O Bank 41 G	HP I/O Bank 61	SYSMON Configuration	GTY Quad 221 X1Y8-X1Y11 (RCAL)
GTY Quad 120 X0Y4-X0Y7 H [LS]	ILKN X0Y0	HP I/O Bank 40 F	HP I/O Bank 60	Configuration	GTY Quad 220 X1Y4-X1Y7
GTY Quad 119 X0Y0-X0Y3	CMAC X0Y0	HP I/O Bank 39	HP I/O Bank 59	PCIE4 X1Y0	GTY Quad 219 X1Y0-X1Y3

X15612-020817

Figure 1-99: XCVU9P Banks in FLGA2104 Package

GTY Quad 133 X0Y56-X0Y59	CMAC X0Y8	HP I/O Bank 53	HP I/O Bank 73	ILKN X1Y8	GTY Quad 233 X1Y56-X1Y59 J [RN]
GTY Quad 132 X0Y52-X0Y55	PCIE4 X0Y5	HP I/O Bank 52	HP I/O Bank 72 O	ILKN X1Y7	GTY Quad 232 X1Y52-X1Y55 I [RN]
GTY Quad 131 X0Y48-X0Y51 (RCAL)	CMAC X0Y7	HP I/O Bank 51	HP I/O Bank 71 N	SYSMON Configuration	GTY Quad 231 X1Y48-X1Y51 H [RN] (RCAL)
GTY Quad 130 X0Y44-X0Y47	ILKN X0Y6	HP I/O Bank 50	HP I/O Bank 70 M	Configuration	GTY Quad 230 X1Y44-X1Y47 G [RN]
GTY Quad 129 X0Y40-X0Y43	CMAC X0Y6	HP I/O Bank 49	HP I/O Bank 69	PCIE4 X1Y4	GTY Quad 229 X1Y40-X1Y43 F [RN]
SLR Crossing					
GTY Quad 128 X0Y36-X0Y39 S [LN]	CMAC X0Y5	HP I/O Bank 48 L	HP I/O Bank 68 F (Partial)	ILKN X1Y5	GTY Quad 228 X1Y36-X1Y39 E [RS]
GTY Quad 127 X0Y32-X0Y35 R [LN]	PCIE4 X0Y3	HP I/O Bank 47 K	HP I/O Bank 67 E	ILKN X1Y4	GTY Quad 227 X1Y32-X1Y35 D [RS]
GTY Quad 126 X0Y28-X0Y31 Q [LN] (RCAL)	CMAC X0Y4	HP I/O Bank 46 J	HP I/O Bank 66 D	SYSMON Configuration	GTY Quad 226 X1Y28-X1Y31 C [RS] (RCAL)
GTY Quad 125 X0Y24-X0Y27 P [LN]	ILKN X0Y3	HP I/O Bank 45	HP I/O Bank 65 C	Configuration	GTY Quad 225 X1Y24-X1Y27 B [RS]
GTY Quad 124 X0Y20-X0Y23 O [LN]	CMAC X0Y3	HP I/O Bank 44	HP I/O Bank 64 B	PCIE4 X1Y2 (tandem)	GTY Quad 224 X1Y20-X1Y23 A [RS]
SLR Crossing					
GTY Quad 123 X0Y16-X0Y19 N [LS]	CMAC X0Y2	HP I/O Bank 43	HP I/O Bank 63	ILKN X1Y2	GTY Quad 223 X1Y16-X1Y19
GTY Quad 122 X0Y12-X0Y15 M [LS]	PCIE4 X0Y1	HP I/O Bank 42 I	HP I/O Bank 62	ILKN X1Y1	GTY Quad 222 X1Y12-X1Y15
GTY Quad 121 X0Y8-X0Y11 L [LS] (RCAL)	CMAC X0Y1	HP I/O Bank 41 H	HP I/O Bank 61	SYSMON Configuration	GTY Quad 221 X1Y8-X1Y11 (RCAL)
GTY Quad 120 X0Y4-X0Y7 K [LS]	ILKN X0Y0	HP I/O Bank 40 G	HP I/O Bank 60	Configuration	GTY Quad 220 X1Y4-X1Y7
GTY Quad 119 X0Y0-X0Y3	CMAC X0Y0	HP I/O Bank 39	HP I/O Bank 59	PCIE4 X1Y0	GTY Quad 219 X1Y0-X1Y3

X15613-020817

Figure 1-100: XCVU9P Banks in FLGB2104 Package

GTY Quad 133 X0Y56-X0Y59 W [LN]	CMAC X0Y8	HP I/O Bank 53	HP I/O Bank 73	ILKN X1Y8	GTY Quad 233 X1Y56-X1Y59 J [RN]
GTY Quad 132 X0Y52-X0Y55 V [LN]	PCIE4 X0Y5	HP I/O Bank 52	HP I/O Bank 72 I	ILKN X1Y7	GTY Quad 232 X1Y52-X1Y55 I [RN]
GTY Quad 131 X0Y48-X0Y51 U [LN] (RCAL)	CMAC X0Y7	HP I/O Bank 51	HP I/O Bank 71 H	SYSMON Configuration	GTY Quad 231 X1Y48-X1Y51 H [RN] (RCAL)
GTY Quad 130 X0Y44-X0Y47 T [LN]	ILKN X0Y6	HP I/O Bank 50	HP I/O Bank 70 G	Configuration	GTY Quad 230 X1Y44-X1Y47 G [RN]
GTY Quad 129 X0Y40-X0Y43 S [LN]	CMAC X0Y6	HP I/O Bank 49	HP I/O Bank 69	PCIE4 X1Y4	GTY Quad 229 X1Y40-X1Y43 F [RN]
SLR Crossing					
GTY Quad 128 X0Y36-X0Y39 R [LC]	CMAC X0Y5	HP I/O Bank 48	HP I/O Bank 68 F	ILKN X1Y5	GTY Quad 228 X1Y36-X1Y39 E [RC]
GTY Quad 127 X0Y32-X0Y35 Q [LC]	PCIE4 X0Y3	HP I/O Bank 47	HP I/O Bank 67 E	ILKN X1Y4	GTY Quad 227 X1Y32-X1Y35 D [RC]
GTY Quad 126 X0Y28-X0Y31 P [LC] (RCAL)	CMAC X0Y4	HP I/O Bank 46	HP I/O Bank 66 D	SYSMON Configuration	GTY Quad 226 X1Y28-X1Y31 C [RC] (RCAL)
GTY Quad 125 X0Y24-X0Y27 O [LC]	ILKN X0Y3	HP I/O Bank 45	HP I/O Bank 65 C	Configuration	GTY Quad 225 X1Y24-X1Y27 B [RC]
GTY Quad 124 X0Y20-X0Y23 N [LC]	CMAC X0Y3	HP I/O Bank 44	HP I/O Bank 64 B	PCIE4 X1Y2 (tandem)	GTY Quad 224 X1Y20-X1Y23 A [RC]
SLR Crossing					
GTY Quad 123 X0Y16-X0Y19	CMAC X0Y2	HP I/O Bank 43	HP I/O Bank 63	ILKN X1Y2	GTY Quad 223 X1Y16-X1Y19
GTY Quad 122 X0Y12-X0Y15 Z [LS]	PCIE4 X0Y1	HP I/O Bank 42	HP I/O Bank 62	ILKN X1Y1	GTY Quad 222 X1Y12-X1Y15 M [RS]
GTY Quad 121 X0Y8-X0Y11 Y [LS] (RCAL)	CMAC X0Y1	HP I/O Bank 41	HP I/O Bank 61	SYSMON Configuration	GTY Quad 221 X1Y8-X1Y11 L [RS] (RCAL)
GTY Quad 120 X0Y4-X0Y7 X [LS]	ILKN X0Y0	HP I/O Bank 40	HP I/O Bank 60	Configuration	GTY Quad 220 X1Y4-X1Y7 K [RS]
GTY Quad 119 X0Y0-X0Y3	CMAC X0Y0	HP I/O Bank 39	HP I/O Bank 59	PCIE4 X1Y0	GTY Quad 219 X1Y0-X1Y3

X15614-020817

Figure 1-101: XCVU9P Banks in FLGC2104 Package

GTY Quad 133 X0Y56-X0Y59	CMAC X0Y8	HP I/O Bank 53	HP I/O Bank 73	ILKN X1Y8	GTY Quad 233 X1Y56-X1Y59 J [RN]
GTY Quad 132 X0Y52-X0Y55	PCIE4 X0Y5	HP I/O Bank 52	HP I/O Bank 72 O	ILKN X1Y7	GTY Quad 232 X1Y52-X1Y55 I [RN]
GTY Quad 131 X0Y48-X0Y51 S [LN] (RCAL)	CMAC X0Y7	HP I/O Bank 51	HP I/O Bank 71 N	SYSMON Configuration	GTY Quad 231 X1Y48-X1Y51 H [RN] (RCAL)
GTY Quad 130 X0Y44-X0Y47	ILKN X0Y6	HP I/O Bank 50	HP I/O Bank 70 M	Configuration	GTY Quad 230 X1Y44-X1Y47 G [RN]
GTY Quad 129 X0Y40-X0Y43	CMAC X0Y6	HP I/O Bank 49	HP I/O Bank 69	PCIE4 X1Y4	GTY Quad 229 X1Y40-X1Y43 F [RN]
SLR Crossing					
GTY Quad 128 X0Y36-X0Y39	CMAC X0Y5	HP I/O Bank 48 L	HP I/O Bank 68	ILKN X1Y5	GTY Quad 228 X1Y36-X1Y39 E [RS]
GTY Quad 127 X0Y32-X0Y35 R [LN]	PCIE4 X0Y3	HP I/O Bank 47 K	HP I/O Bank 67 E	ILKN X1Y4	GTY Quad 227 X1Y32-X1Y35 D [RS]
GTY Quad 126 X0Y28-X0Y31 Q [LN] (RCAL)	CMAC X0Y4	HP I/O Bank 46 J	HP I/O Bank 66 D	SYSMON Configuration	GTY Quad 226 X1Y28-X1Y31 C [RS] (RCAL)
GTY Quad 125 X0Y24-X0Y27 P [LN]	ILKN X0Y3	HP I/O Bank 45	HP I/O Bank 65 C	Configuration	GTY Quad 225 X1Y24-X1Y27 B [RS]
GTY Quad 124 X0Y20-X0Y23 O [LN]	CMAC X0Y3	HP I/O Bank 44	HP I/O Bank 64 B	PCIE4 X1Y2 (tandem)	GTY Quad 224 X1Y20-X1Y23 A [RS]
SLR Crossing					
GTY Quad 123 X0Y16-X0Y19 N [LS]	CMAC X0Y2	HP I/O Bank 43	HP I/O Bank 63	ILKN X1Y2	GTY Quad 223 X1Y16-X1Y19
GTY Quad 122 X0Y12-X0Y15 M [LS]	PCIE4 X0Y1	HP I/O Bank 42 H	HP I/O Bank 62	ILKN X1Y1	GTY Quad 222 X1Y12-X1Y15
GTY Quad 121 X0Y8-X0Y11 L [LS](RCAL)	CMAC X0Y1	HP I/O Bank 41 G	HP I/O Bank 61	SYSMON Configuration	GTY Quad 221 X1Y8-X1Y11
GTY Quad 120 X0Y4-X0Y7 K [LS]	ILKN X0Y0	HP I/O Bank 40 F	HP I/O Bank 60	Configuration	GTY Quad 220 X1Y4-X1Y7
GTY Quad 119 X0Y0-X0Y3	CMAC X0Y0	HP I/O Bank 39	HP I/O Bank 59	PCIE4 X1Y0	GTY Quad 219 X1Y0-X1Y3

X18713-020817

Figure 1-102: XCVU9P Banks in FSGD2104 Package

GTU Quad 133 X0Y56-X0Y59 Z [LN]	CMAC X0Y8	HP I/O Bank 53	HP I/O Bank 73	ILKN X1Y8	GTU Quad 233 X1Y56-X1Y59 J [RN]
GTU Quad 132 X0Y52-X0Y55 Y [LN]	PCIE4 X0Y5	HP I/O Bank 52	HP I/O Bank 72 K	ILKN X1Y7	GTU Quad 232 X1Y52-X1Y55 I [RN]
GTU Quad 131 X0Y48-X0Y51 X [LN] (RCAL)	CMAC X0Y7	HP I/O Bank 51	HP I/O Bank 71 J	SYSMON Configuration	GTU Quad 231 X1Y48-X1Y51 H [RN] (RCAL)
GTU Quad 130 X0Y44-X0Y47 W [LUC]	ILKN X0Y6	HP I/O Bank 50	HP I/O Bank 70 I	Configuration	GTU Quad 230 X1Y44-X1Y47 G [RUC]
GTU Quad 129 X0Y40-X0Y43 V [LUC]	CMAC X0Y6	HP I/O Bank 49	HP I/O Bank 69	PCIE4 X1Y4	GTU Quad 229 X1Y40-X1Y43 F [RUC]
SLR Crossing					
GTU Quad 128 X0Y36-X0Y39 U [LUC]	CMAC X0Y5	HP I/O Bank 48	HP I/O Bank 68 H (Partial)	ILKN X1Y5	GTU Quad 228 X1Y36-X1Y39 E [RUC]
GTU Quad 127 X0Y32-X0Y35 T [LUC]	PCIE4 X0Y3	HP I/O Bank 47	HP I/O Bank 67 G	ILKN X1Y4	GTU Quad 227 X1Y32-X1Y35 D [RUC]
GTU Quad 126 X0Y28-X0Y31 S [LLC] (RCAL)	CMAC X0Y4	HP I/O Bank 46	HP I/O Bank 66 B (Partial)	SYSMON Configuration	GTU Quad 226 X1Y28-X1Y31 C [RLC] (RCAL)
GTU Quad 125 X0Y24-X0Y27 R [LLC]	ILKN X0Y3	HP I/O Bank 45	HP I/O Bank 65 C	Configuration	GTU Quad 225 X1Y24-X1Y27 B [RLC]
GTU Quad 124 X0Y20-X0Y23 Q [LLC]	CMAC X0Y3	HP I/O Bank 44	HP I/O Bank 64	PCIE4 X1Y2 (tandem)	GTU Quad 224 X1Y20-X1Y23 A [RLC]
SLR Crossing					
GTU Quad 123 X0Y16-X0Y19 AF [LLC]	CMAC X0Y2	HP I/O Bank 43	HP I/O Bank 63 F	ILKN X1Y2	GTU Quad 223 X1Y16-X1Y19 P [RLC]
GTU Quad 122 X0Y12-X0Y15 AE [LS]	PCIE4 X0Y1	HP I/O Bank 42	HP I/O Bank 62 E	ILKN X1Y1	GTU Quad 222 X1Y12-X1Y15 O [RS]
GTU Quad 121 X0Y8-X0Y11 AD [LS] (RCAL)	CMAC X0Y1	HP I/O Bank 41	HP I/O Bank 61 D	SYSMON Configuration	GTU Quad 221 X1Y8-X1Y11 N [RS] (RCAL)
GTU Quad 120 X0Y4-X0Y7 AC [LS]	ILKN X0Y0	HP I/O Bank 40	HP I/O Bank 60	Configuration	GTU Quad 220 X1Y4-X1Y7 M [RS]
GTU Quad 119 X0Y0-X0Y3 AB [LS]	CMAC X0Y0	HP I/O Bank 39	HP I/O Bank 59	PCIE4 X1Y0	GTU Quad 219 X1Y0-X1Y3 L [RS]

X15615-020817

Figure 1-103: XCVU9P Banks in FLGA2577 Package

XCVU11P and XQVU11P Bank Diagrams

GTU Quad 135 X0Y44-X0Y47	CMAC X0Y8	HP I/O Bank 75	ILKN X1Y5	GTU Quad 235 X1Y44-X1Y47
GTU Quad 134 X0Y40-X0Y43	CMAC X0Y7	HP I/O Bank 74	SYSMON Configuration	GTU Quad 234 X1Y40-X1Y43
GTU Quad 133 X0Y36-X0Y39 (RCAL)	ILKN X0Y4	HP I/O Bank 73	Configuration	GTU Quad 233 X1Y36-X1Y39 (RCAL)
GTU Quad 132 X0Y32-X0Y35	CMAC X0Y6	HP I/O Bank 72	PCIE4 X0Y2	GTU Quad 232 X1Y32-X1Y35
SLR Crossing				
GTU Quad 131 X0Y28-X0Y31	CMAC X0Y5	HP I/O Bank 71	ILKN X1Y3	GTU Quad 231 X1Y28-X1Y31
GTU Quad 130 X0Y24-X0Y27	CMAC X0Y4	HP I/O Bank 70	SYSMON Configuration	GTU Quad 230 X1Y24-X1Y27
GTU Quad 129 X0Y20-X0Y23 (RCAL)	ILKN X0Y2	HP I/O Bank 69	Configuration	GTU Quad 229 X1Y20-X1Y23 (RCAL)
GTU Quad 128 X0Y16-X0Y19	CMAC X0Y3	HP I/O Bank 68	PCIE4 X0Y1	GTU Quad 228 X1Y16-X1Y19
SLR Crossing				
GTU Quad 127 X0Y12-X0Y15	CMAC X0Y2	HP I/O Bank 67	ILKN X1Y1	GTU Quad 227 X1Y12-X1Y15
GTU Quad 126 X0Y8-X0Y11	CMAC X0Y1	HP I/O Bank 66	SYSMON Configuration	GTU Quad 226 X1Y8-X1Y11
GTU Quad 125 X0Y4-X0Y7 (RCAL)	ILKN X0Y0	HP I/O Bank 65	Configuration	GTU Quad 225 X1Y4-X1Y7 (RCAL)
GTU Quad 124 X0Y0-X0Y3	CMAC X0Y0	HP I/O Bank 64	PCIE4 X0Y0 (tandem)	GTU Quad 224 X1Y0-X1Y3

X15616-020817

Figure 1-104: XCVU11P and XQVU11P Banks

GTY Quad 135 X0Y44-X0Y47	CMAC X0Y8	HP I/O Bank 75 P	ILKN X1Y5	GTY Quad 235 X1Y44-X1Y47
GTY Quad 134 X0Y40-X0Y43	CMAC X0Y7	HP I/O Bank 74 O	SYSMON Configuration	GTY Quad 234 X1Y40-X1Y43
GTY Quad 133 X0Y36-X0Y39 (RCAL)	ILKN X0Y4	HP I/O Bank 73 N	Configuration	GTY Quad 233 X1Y36-X1Y39 J [RN] (RCAL)
GTY Quad 132 X0Y32-X0Y35	CMAC X0Y6	HP I/O Bank 72 M	PCIE4 X0Y2	GTY Quad 232 X1Y32-X1Y35 I [RN]
SLR Crossing				
GTY Quad 131 X0Y28-X0Y31 P [LN]	CMAC X0Y5	HP I/O Bank 71 L	ILKN X1Y3	GTY Quad 231 X1Y28-X1Y31 H [RN]
GTY Quad 130 X0Y24-X0Y27 Q [LN]	CMAC X0Y4	HP I/O Bank 70 K	SYSMON Configuration	GTY Quad 230 X1Y24-X1Y27 G [RN]
GTY Quad 129 X0Y20-X0Y23 N [LN] (RCAL)	ILKN X0Y2	HP I/O Bank 69 J	Configuration	GTY Quad 229 X1Y20-X1Y23 F [RN] (RCAL)
GTY Quad 128 X0Y16-X0Y19	CMAC X0Y3	HP I/O Bank 68 F	PCIE4 X0Y1	GTY Quad 228 X1Y16-X1Y19 E [RS]
SLR Crossing				
GTY Quad 127 X0Y12-X0Y15 M [LS]	CMAC X0Y2	HP I/O Bank 67 E	ILKN X1Y1	GTY Quad 227 X1Y12-X1Y15 D [RS]
GTY Quad 126 X0Y8-X0Y11 L [LS]	CMAC X0Y1	HP I/O Bank 66 D	SYSMON Configuration	GTY Quad 226 X1Y8-X1Y11 C [RS]
GTY Quad 125 X0Y4-X0Y7 K [LS] (RCAL)	ILKN X0Y0	HP I/O Bank 65 C	Configuration	GTY Quad 225 X1Y4-X1Y7 B [RS] (RCAL)
GTY Quad 124 X0Y0-X0Y3	CMAC X0Y0	HP I/O Bank 64 G	PCIE4 X0Y0 (tandem)	GTY Quad 224 X1Y0-X1Y3 A [RS]

X15620-020817

Figure 1-105: XCVU11P Banks in FLGF1924 Package

GTY Quad 135 X0Y44-X0Y47	CMAC X0Y8	HP I/O Bank 75	ILKN X1Y5	GTY Quad 235 X1Y44-X1Y47
GTY Quad 134 X0Y40-X0Y43	CMAC X0Y7	HP I/O Bank 74 O	SYSMON Configuration	GTY Quad 234 X1Y40-X1Y43
GTY Quad 133 X0Y36-X0Y39 S [LN] (RCAL)	ILKN X0Y4	HP I/O Bank 73 N	Configuration	GTY Quad 233 X1Y36-X1Y39 J [RN] (RCAL)
GTY Quad 132 X0Y32-X0Y35	CMAC X0Y6	HP I/O Bank 72 M	PCIE4 X0Y2	GTY Quad 232 X1Y32-X1Y35 I [RN]
SLR Crossing				
GTY Quad 131 X0Y28-X0Y31 R [LN]	CMAC X0Y5	HP I/O Bank 71 L	ILKN X1Y3	GTY Quad 231 X1Y28-X1Y31 H [RN]
GTY Quad 130 X0Y24-X0Y27 Q [LN]	CMAC X0Y4	HP I/O Bank 70 K	SYSMON Configuration	GTY Quad 230 X1Y24-X1Y27 G [RN]
GTY Quad 129 X0Y20-X0Y23 P [LN] (RCAL)	ILKN X0Y2	HP I/O Bank 69 J	Configuration	GTY Quad 229 X1Y20-X1Y23 F [RN] (RCAL)
GTY Quad 128 X0Y16-X0Y19 O [LN]	CMAC X0Y3	HP I/O Bank 68 G	PCIE4 X0Y1	GTY Quad 228 X1Y16-X1Y19 E [RS]
SLR Crossing				
GTY Quad 127 X0Y12-X0Y15 N [LS]	CMAC X0Y2	HP I/O Bank 67 E	ILKN X1Y1	GTY Quad 227 X1Y12-X1Y15 D [RS]
GTY Quad 126 X0Y8-X0Y11 M [LS]	CMAC X0Y1	HP I/O Bank 66 D	SYSMON Configuration	GTY Quad 226 X1Y8-X1Y11 C [RS]
GTY Quad 125 X0Y4-X0Y7 L [LS] (RCAL)	ILKN X0Y0	HP I/O Bank 65 C	Configuration	GTY Quad 225 X1Y4-X1Y7 B [RS] (RCAL)
GTY Quad 124 X0Y0-X0Y3 K [LS]	CMAC X0Y0	HP I/O Bank 64 B	PCIE4 X0Y0 (tandem)	GTY Quad 224 X1Y0-X1Y3 A [RS]

X15617-020817

Figure 1-106: XCVU11P Banks in FLGB2104 Package

GTY Quad 135 X0Y44-X0Y47 W [LN]	CMAC X0Y8	HP I/O Bank 75	ILKN X1Y5	GTY Quad 235 X1Y44-X1Y47 J [RN]
GTY Quad 134 X0Y40-X0Y43 V [LN]	CMAC X0Y7	HP I/O Bank 74	SYSMON Configuration	GTY Quad 234 X1Y40-X1Y43 I [RN]
GTY Quad 133 X0Y36-X0Y39 U [LN] (RCAL)	ILKN X0Y4	HP I/O Bank 73	Configuration	GTY Quad 233 X1Y36-X1Y39 H [RN] (RCAL)
GTY Quad 132 X0Y32-X0Y35 T [LN]	CMAC X0Y6	HP I/O Bank 72	PCIE4 X0Y2	GTY Quad 232 X1Y32-X1Y35 G [RN]
SLR Crossing				
GTY Quad 131 X0Y28-X0Y31 S [LN]	CMAC X0Y5	HP I/O Bank 71 I	ILKN X1Y3	GTY Quad 231 X1Y28-X1Y31 F [RN]
GTY Quad 130 X0Y24-X0Y27 R [LC]	CMAC X0Y4	HP I/O Bank 70 H	SYSMON Configuration	GTY Quad 230 X1Y24-X1Y27 E [RC]
GTY Quad 129 X0Y20-X0Y23 Q [LC] (RCAL)	ILKN X0Y2	HP I/O Bank 69 G	Configuration	GTY Quad 229 X1Y20-X1Y23 D [RC] (RCAL)
GTY Quad 128 X0Y16-X0Y19 P [LC]	CMAC X0Y3	HP I/O Bank 68 F	PCIE4 X0Y1	GTY Quad 228 X1Y16-X1Y19 C [RC]
SLR Crossing				
GTY Quad 127 X0Y12-X0Y15 O [LC]	CMAC X0Y2	HP I/O Bank 67 E	ILKN X1Y1	GTY Quad 227 X1Y12-X1Y15 B [RC]
GTY Quad 126 X0Y8-X0Y11 N [LC]	CMAC X0Y1	HP I/O Bank 66 D	SYSMON Configuration	GTY Quad 226 X1Y8-X1Y11 A [RC]
GTY Quad 125 X0Y4-X0Y7 Z [LS] (RCAL)	ILKN X0Y0	HP I/O Bank 65 C	Configuration	GTY Quad 225 X1Y4-X1Y7 M [RS] (RCAL)
GTY Quad 124 X0Y0-X0Y3 Y [LS]	CMAC X0Y0	HP I/O Bank 64 B	PCIE4 X0Y0 (tandem)	GTY Quad 224 X1Y0-X1Y3 L [RS]

X15618-020817

Figure 1-107: XCVU11P Banks in FLGC2104 Package and XQVU11P Banks in FLRC2104 Package

GTY Quad 135 X0Y44-X0Y47	CMAC X0Y8	HP I/O Bank 75	ILKN X1Y5	GTY Quad 235 X1Y44-X1Y47
GTY Quad 134 X0Y40-X0Y43	CMAC X0Y7	HP I/O Bank 74 O	SYSMON Configuration	GTY Quad 234 X1Y40-X1Y43
GTY Quad 133 X0Y36-X0Y39 S [LN] (RCAL)	ILKN X0Y4	HP I/O Bank 73 N	Configuration	GTY Quad 233 X1Y36-X1Y39 J [RN] (RCAL)
GTY Quad 132 X0Y32-X0Y35	CMAC X0Y6	HP I/O Bank 72 M	PCIE4 X0Y2	GTY Quad 232 X1Y32-X1Y35 I [RN]
SLR Crossing				
GTY Quad 131 X0Y28-X0Y31 R [LN]	CMAC X0Y5	HP I/O Bank 71 L	ILKN X1Y3	GTY Quad 231 X1Y28-X1Y31 H [RN]
GTY Quad 130 X0Y24-X0Y27 Q [LN]	CMAC X0Y4	HP I/O Bank 70 K	SYSMON Configuration	GTY Quad 230 X1Y24-X1Y27 G [RN]
GTY Quad 129 X0Y20-X0Y23 P [LN] (RCAL)	ILKN X0Y2	HP I/O Bank 69 J	Configuration	GTY Quad 229 X1Y20-X1Y23 F [RN] (RCAL)
GTY Quad 128 X0Y16-X0Y19 O [LN]	CMAC X0Y3	HP I/O Bank 68 F	PCIE4 X0Y1	GTY Quad 228 X1Y16-X1Y19 E [RS]
SLR Crossing				
GTY Quad 127 X0Y12-X0Y15 N [LS]	CMAC X0Y2	HP I/O Bank 67 E	ILKN X1Y1	GTY Quad 227 X1Y12-X1Y15 D [RS]
GTY Quad 126 X0Y8-X0Y11 M [LS]	CMAC X0Y1	HP I/O Bank 66 D	SYSMON Configuration	GTY Quad 226 X1Y8-X1Y11 C [RS]
GTY Quad 125 X0Y4-X0Y7 L [LS] (RCAL)	ILKN X0Y0	HP I/O Bank 65 C	Configuration	GTY Quad 225 X1Y4-X1Y7 B [RS] (RCAL)
GTY Quad 124 X0Y0-X0Y3 K [LS]	CMAC X0Y0	HP I/O Bank 64 B	PCIE4 X0Y0 (tandem)	GTY Quad 224 X1Y0-X1Y3 A [RS]

X18714-020817

Figure 1-108: XCVU11P Banks in FSGD2104 Package

GTY Quad 135 X0Y44-X0Y47 AA [LN]	CMAC X0Y8	HP I/O Bank 75 K	ILKN X1Y5	GTY Quad 235 X1Y44-X1Y47 K [RN]
GTY Quad 134 X0Y40-X0Y43 Z [LN]	CMAC X0Y7	HP I/O Bank 74 J	SYSMON Configuration	GTY Quad 234 X1Y40-X1Y43 J [RN]
GTY Quad 133 X0Y36-X0Y39 Y [LN] (RCAL)	ILKN X0Y4	HP I/O Bank 73 I	Configuration	GTY Quad 233 X1Y36-X1Y39 I [RN] (RCAL)
GTY Quad 132 X0Y32-X0Y35 X [LN]	CMAC X0Y6	HP I/O Bank 72 H (Partial)	PCIE4 X0Y2	GTY Quad 232 X1Y32-X1Y35 H [RN]
SLR Crossing				
GTY Quad 131 X0Y28-X0Y31 W [LUC]	CMAC X0Y5	HP I/O Bank 71 G	ILKN X1Y3	GTY Quad 231 X1Y28-X1Y31 G [RUC]
GTY Quad 130 X0Y24-X0Y27 V [LUC]	CMAC X0Y4	HP I/O Bank 70 F	SYSMON Configuration	GTY Quad 230 X1Y24-X1Y27 F [RUC]
GTY Quad 129 X0Y20-X0Y23 U [LUC] (RCAL)	ILKN X0Y2	HP I/O Bank 69 E	Configuration	GTY Quad 229 X1Y20-X1Y23 E [RUC] (RCAL)
GTY Quad 128 X0Y16-X0Y19 T [LUC]	CMAC X0Y3	HP I/O Bank 68 D	PCIE4 X0Y1	GTY Quad 228 X1Y16-X1Y19 D [RUC]
SLR Crossing				
GTY Quad 127 X0Y12-X0Y15 S [LLC]	CMAC X0Y2	HP I/O Bank 67 A	ILKN X1Y1	GTY Quad 227 X1Y12-X1Y15 C [RLC]
GTY Quad 126 X0Y8-X0Y11 R [LLC]	CMAC X0Y1	HP I/O Bank 66 B (Partial)	SYSMON Configuration	GTY Quad 226 X1Y8-X1Y11 B [RLC]
GTY Quad 125 X0Y4-X0Y7 Q [LLC] (RCAL)	ILKN X0Y0	HP I/O Bank 65 C	Configuration	GTY Quad 225 X1Y4-X1Y7 A [RLC] (RCAL)
GTY Quad 124 X0Y0-X0Y3 AF [LLC]	CMAC X0Y0	HP I/O Bank 64 P	PCIE4 X0Y0 (tandem)	GTY Quad 224 X1Y0-X1Y3 P [RLC]

X15619-020817

Figure 1-109: XCVU11P Banks in FLGA2577 Package

XCVU13P Bank Diagrams

GTY Quad 135 X0Y60-X0Y63	CMAC X0Y11	HP I/O Bank 75	ILKN X1Y7	GTY Quad 235 X1Y60-X1Y63
GTY Quad 134 X0Y56-X0Y59	CMAC X0Y10	HP I/O Bank 74	SYSMON Configuration	GTY Quad 234 X1Y56-X1Y59
GTY Quad 133 X0Y52-X0Y55 (RCAL)	ILKN X0Y6	HP I/O Bank 73	Configuration	GTY Quad 233 X1Y52-X1Y55 (RCAL)
GTY Quad 132 X0Y48-X0Y51	CMAC X0Y9	HP I/O Bank 72	PCIE4 X0Y3	GTY Quad 232 X1Y48-X1Y51
SLR Crossing				
GTY Quad 131 X0Y44-X0Y47	CMAC X0Y8	HP I/O Bank 71	ILKN X1Y5	GTY Quad 231 X1Y44-X1Y47
GTY Quad 130 X0Y40-X0Y43	CMAC X0Y7	HP I/O Bank 70	SYSMON Configuration	GTY Quad 230 X1Y40-X1Y43
GTY Quad 129 X0Y36-X0Y39 (RCAL)	ILKN X0Y4	HP I/O Bank 69	Configuration	GTY Quad 229 X1Y36-X1Y39 (RCAL)
GTY Quad 128 X0Y32-X0Y35	CMAC X0Y6	HP I/O Bank 68	PCIE4 X0Y2	GTY Quad 228 X1Y32-X1Y35
SLR Crossing				
GTY Quad 127 X0Y28-X0Y31	CMAC X0Y5	HP I/O Bank 67	ILKN X1Y3	GTY Quad 227 X1Y28-X1Y31
GTY Quad 126 X0Y24-X0Y27	CMAC X0Y4	HP I/O Bank 66	SYSMON Configuration	GTY Quad 226 X1Y24-X1Y27
GTY Quad 125 X0Y20-X0Y23 (RCAL)	ILKN X0Y2	HP I/O Bank 65	Configuration	GTY Quad 225 X1Y20-X1Y23 (RCAL)
GTY Quad 124 X0Y16-X0Y19	CMAC X0Y3	HP I/O Bank 64	PCIE4 X0Y1 (tandem)	GTY Quad 224 X1Y16-X1Y19
SLR Crossing				
GTY Quad 123 X0Y12-X0Y15	CMAC X0Y2	HP I/O Bank 63	ILKN X1Y1	GTY Quad 223 X1Y12-X1Y15
GTY Quad 122 X0Y8-X0Y11	CMAC X0Y1	HP I/O Bank 62	SYSMON Configuration	GTY Quad 222 X1Y8-X1Y11
GTY Quad 121 X0Y4-X0Y7 (RCAL)	ILKN X0Y0	HP I/O Bank 61	Configuration	GTY Quad 221 X1Y4-X1Y7 (RCAL)
GTY Quad 120 X0Y0-X0Y3	CMAC X0Y0	HP I/O Bank 60	PCIE4 X0Y0	GTY Quad 220 X1Y0-X1Y3

X15621-020817

Figure 1-110: XCVU13P Banks

GTY Quad 135 X0Y60-X0Y63	CMAC X0Y11	HP I/O Bank 75 Q	ILKN X1Y7	GTY Quad 235 X1Y60-X1Y63
GTY Quad 134 X0Y56-X0Y59	CMAC X0Y10	HP I/O Bank 74 P	SYSMON Configuration	GTY Quad 234 X1Y56-X1Y59
GTY Quad 133 X0Y52-X0Y55 (RCAL)	ILKN X0Y6	HP I/O Bank 73 O	Configuration	GTY Quad 233 X1Y52-X1Y55 (RCAL)
GTY Quad 132 X0Y48-X0Y51	CMAC X0Y9	HP I/O Bank 72 N	PCIE4 X0Y3	GTY Quad 232 X1Y48-X1Y51
SLR Crossing				
GTY Quad 131 X0Y44-X0Y47 M [LN]	CMAC X0Y8	HP I/O Bank 71 M	ILKN X1Y5	GTY Quad 231 X1Y44-X1Y47 G [RN]
GTY Quad 130 X0Y40-X0Y43 L [LN]	CMAC X0Y7	HP I/O Bank 70 L	SYSMON Configuration	GTY Quad 230 X1Y40-X1Y43 F [RN]
GTY Quad 129 X0Y36-X0Y39 K [LN] (RCAL)	ILKN X0Y4	HP I/O Bank 69 K	Configuration	GTY Quad 229 X1Y36-X1Y39 E [RN] (RCAL)
GTY Quad 128 X0Y32-X0Y35	CMAC X0Y6	HP I/O Bank 68 J	PCIE4 X0Y2	GTY Quad 228 X1Y32-X1Y35
SLR Crossing				
GTY Quad 127 X0Y28-X0Y31 J [LS]	CMAC X0Y5	HP I/O Bank 67 E	ILKN X1Y3	GTY Quad 227 X1Y28-X1Y31 D [RS]
GTY Quad 126 X0Y24-X0Y27 I [LS]	CMAC X0Y4	HP I/O Bank 66 D	SYSMON Configuration	GTY Quad 226 X1Y24-X1Y27 C [RS]
GTY Quad 125 X0Y20-X0Y23 H [LS] (RCAL)	ILKN X0Y2	HP I/O Bank 65 C	Configuration	GTY Quad 225 X1Y20-X1Y23 B [RS] (RCAL)
GTY Quad 124 X0Y16-X0Y19	CMAC X0Y3	HP I/O Bank 64 B	PCIE4 X0Y1 (tandem)	GTY Quad 224 X1Y16-X1Y19 A [RS]
SLR Crossing				
GTY Quad 123 X0Y12-X0Y15	CMAC X0Y2	HP I/O Bank 63 I	ILKN X1Y1	GTY Quad 223 X1Y12-X1Y15
GTY Quad 122 X0Y8-X0Y11	CMAC X0Y1	HP I/O Bank 62 H	SYSMON Configuration	GTY Quad 222 X1Y8-X1Y11
GTY Quad 121 X0Y4-X0Y7 (RCAL)	ILKN X0Y0	HP I/O Bank 61 G	Configuration	GTY Quad 221 X1Y4-X1Y7 (RCAL)
GTY Quad 120 X0Y0-X0Y3	CMAC X0Y0	HP I/O Bank 60 F	PCIE4 X0Y0	GTY Quad 220 X1Y0-X1Y3

X15622-020817

Figure 1-111: XCVU13P Banks in FHGA2104 Package

GTY Quad 135 X0Y60-X0Y63	CMAC X0Y11	HP I/O Bank 75	ILKN X1Y7	GTY Quad 235 X1Y60-X1Y63
GTY Quad 134 X0Y56-X0Y59	CMAC X0Y10	HP I/O Bank 74 O	SYSMON Configuration	GTY Quad 234 X1Y56-X1Y59
GTY Quad 133 X0Y52-X0Y55 S [LN] (RCAL)	ILKN X0Y6	HP I/O Bank 73 N	Configuration	GTY Quad 233 X1Y52-X1Y55 J [RN] (RCAL)
GTY Quad 132 X0Y48-X0Y51	CMAC X0Y9	HP I/O Bank 72 M	PCIE4 X0Y3	GTY Quad 232 X1Y48-X1Y51 I [RN]
SLR Crossing				
GTY Quad 131 X0Y44-X0Y47 R [LN]	CMAC X0Y8	HP I/O Bank 71 L	ILKN X1Y5	GTY Quad 231 X1Y44-X1Y47 H [RN]
GTY Quad 130 X0Y40-X0Y43 Q [LN]	CMAC X0Y7	HP I/O Bank 70 K	SYSMON Configuration	GTY Quad 230 X1Y40-X1Y43 G [RN]
GTY Quad 129 X0Y36-X0Y39 P [LN] (RCAL)	ILKN X0Y4	HP I/O Bank 69 J	Configuration	GTY Quad 229 X1Y36-X1Y39 F [RN] (RCAL)
GTY Quad 128 X0Y32-X0Y35 O [LN]	CMAC X0Y6	HP I/O Bank 68 F (Partial)	PCIE4 X0Y2	GTY Quad 228 X1Y32-X1Y35 E [RS]
SLR Crossing				
GTY Quad 127 X0Y28-X0Y31 N [LS]	CMAC X0Y5	HP I/O Bank 67 E	ILKN X1Y3	GTY Quad 227 X1Y28-X1Y31 D [RS]
GTY Quad 126 X0Y24-X0Y27 M [LS]	CMAC X0Y4	HP I/O Bank 66 D	SYSMON Configuration	GTY Quad 226 X1Y24-X1Y27 C [RS]
GTY Quad 125 X0Y20-X0Y23 L [LS] (RCAL)	ILKN X0Y2	HP I/O Bank 65 C	Configuration	GTY Quad 225 X1Y20-X1Y23 B [RS] (RCAL)
GTY Quad 124 X0Y16-X0Y19 K [LS]	CMAC X0Y3	HP I/O Bank 64 B	PCIE4 X0Y1 (tandem)	GTY Quad 224 X1Y16-X1Y19 A [RS]
SLR Crossing				
GTY Quad 123 X0Y12-X0Y15	CMAC X0Y2	HP I/O Bank 63 I	ILKN X1Y1	GTY Quad 223 X1Y12-X1Y15
GTY Quad 122 X0Y8-X0Y11	CMAC X0Y1	HP I/O Bank 62 H	SYSMON Configuration	GTY Quad 222 X1Y8-X1Y11
GTY Quad 121 X0Y4-X0Y7 (RCAL)	ILKN X0Y0	HP I/O Bank 61 G	Configuration	GTY Quad 221 X1Y4-X1Y7 (RCAL)
GTY Quad 120 X0Y0-X0Y3	CMAC X0Y0	HP I/O Bank 60 F	PCIE4 X0Y0	GTY Quad 220 X1Y0-X1Y3

X15623-020817

Figure 1-112: XCVU13P Banks in FHGB2104 Package

GTY Quad 135 X0Y60-X0Y63	CMAC X0Y11	HP I/O Bank 75	ILKN X1Y7	GTY Quad 235 X1Y60-X1Y63
GTY Quad 134 X0Y56-X0Y59	CMAC X0Y10	HP I/O Bank 74	SYSMON Configuration	GTY Quad 234 X1Y56-X1Y59
GTY Quad 133 X0Y52-X0Y55 W [LN] (RCAL)	ILKN X0Y6	HP I/O Bank 73	Configuration	GTY Quad 233 X1Y52-X1Y55 J [RN] (RCAL)
GTY Quad 132 X0Y48-X0Y51 V [LN]	CMAC X0Y9	HP I/O Bank 72	PCIE4 X0Y3	GTY Quad 232 X1Y48-X1Y51 I [RN]
SLR Crossing				
GTY Quad 131 X0Y44-X0Y47 U [LN]	CMAC X0Y8	HP I/O Bank 71 I	ILKN X1Y5	GTY Quad 231 X1Y44-X1Y47 H [RN]
GTY Quad 130 X0Y40-X0Y43 T [LN]	CMAC X0Y7	HP I/O Bank 70 H	SYSMON Configuration	GTY Quad 230 X1Y40-X1Y43 G [RN]
GTY Quad 129 X0Y36-X0Y39 S [LN] (RCAL)	ILKN X0Y4	HP I/O Bank 69 G	Configuration	GTY Quad 229 X1Y36-X1Y39 F [RN] (RCAL)
GTY Quad 128 X0Y32-X0Y35 R [LC]	CMAC X0Y6	HP I/O Bank 68 F	PCIE4 X0Y2	GTY Quad 228 X1Y32-X1Y35 E [RC]
SLR Crossing				
GTY Quad 127 X0Y28-X0Y31 Q [LC]	CMAC X0Y5	HP I/O Bank 67 E	ILKN X1Y3	GTY Quad 227 X1Y28-X1Y31 D [RC]
GTY Quad 126 X0Y24-X0Y27 P [LC]	CMAC X0Y4	HP I/O Bank 66 D	SYSMON Configuration	GTY Quad 226 X1Y24-X1Y27 C [RC]
GTY Quad 125 X0Y20-X0Y23 O [LC] (RCAL)	ILKN X0Y2	HP I/O Bank 65 C	Configuration	GTY Quad 225 X1Y20-X1Y23 B [RC] (RCAL)
GTY Quad 124 X0Y16-X0Y19 N [LC]	CMAC X0Y3	HP I/O Bank 64 B	PCIE4 X0Y1 (tandem)	GTY Quad 224 X1Y16-X1Y19 A [RC]
SLR Crossing				
GTY Quad 123 X0Y12-X0Y15 Z [LS]	CMAC X0Y2	HP I/O Bank 63	ILKN X1Y1	GTY Quad 223 X1Y12-X1Y15 M [RS]
GTY Quad 122 X0Y8-X0Y11 Y [LS]	CMAC X0Y1	HP I/O Bank 62	SYSMON Configuration	GTY Quad 222 X1Y8-X1Y11 L [RS]
GTY Quad 121 X0Y4-X0Y7 X [LS] (RCAL)	ILKN X0Y0	HP I/O Bank 61	Configuration	GTY Quad 221 X1Y4-X1Y7 K [RS] (RCAL)
GTY Quad 120 X0Y0-X0Y3	CMAC X0Y0	HP I/O Bank 60	PCIE4 X0Y0	GTY Quad 220 X1Y0-X1Y3

X15624-020817

Figure 1-113: XCVU13P Banks in FHGC2104 Package

GTY Quad 135 X0Y60-X0Y63	CMAC X0Y11	HP I/O Bank 75	ILKN X1Y7	GTY Quad 235 X1Y60-X1Y63
GTY Quad 134 X0Y56-X0Y59	CMAC X0Y10	HP I/O Bank 74 O	SYSMON Configuration	GTY Quad 234 X1Y56-X1Y59
GTY Quad 133 X0Y52-X0Y55 S [LN] (RCAL)	ILKN X0Y6	HP I/O Bank 73 N	Configuration	GTY Quad 233 X1Y52-X1Y55 J [RN] (RCAL)
GTY Quad 132 X0Y48-X0Y51	CMAC X0Y9	HP I/O Bank 72 M	PCIE4 X0Y3	GTY Quad 232 X1Y48-X1Y51 I [RN]
SLR Crossing				
GTY Quad 131 X0Y44-X0Y47 R [LN]	CMAC X0Y8	HP I/O Bank 71 L	ILKN X1Y5	GTY Quad 231 X1Y44-X1Y47 H [RN]
GTY Quad 130 X0Y40-X0Y43 Q [LN]	CMAC X0Y7	HP I/O Bank 70 K	SYSMON Configuration	GTY Quad 230 X1Y40-X1Y43 G [RN]
GTY Quad 129 X0Y36-X0Y39 P [LN] (RCAL)	ILKN X0Y4	HP I/O Bank 69 J	Configuration	GTY Quad 229 X1Y36-X1Y39 F [RN] (RCAL)
GTY Quad 128 X0Y32-X0Y35 O [LC]	CMAC X0Y6	HP I/O Bank 68	PCIE4 X0Y2	GTY Quad 228 X1Y32-X1Y35 E [RC]
SLR Crossing				
GTY Quad 127 X0Y28-X0Y31	CMAC X0Y5	HP I/O Bank 67 E	ILKN X1Y3	GTY Quad 227 X1Y28-X1Y31 D [RC]
GTY Quad 126 X0Y24-X0Y27	CMAC X0Y4	HP I/O Bank 66 D	SYSMON Configuration	GTY Quad 226 X1Y24-X1Y27 C [RC]
GTY Quad 125 X0Y20-X0Y23 (RCAL)	ILKN X0Y2	HP I/O Bank 65 C	Configuration	GTY Quad 225 X1Y20-X1Y23 B [RC] (RCAL)
GTY Quad 124 X0Y16-X0Y19	CMAC X0Y3	HP I/O Bank 64 B	PCIE4 X0Y1 (tandem)	GTY Quad 224 X1Y16-X1Y19 A [RC]
SLR Crossing				
GTY Quad 123 X0Y12-X0Y15 N [LS]	CMAC X0Y2	HP I/O Bank 63 H	ILKN X1Y1	GTY Quad 223 X1Y12-X1Y15
GTY Quad 122 X0Y8-X0Y11 M [LS]	CMAC X0Y1	HP I/O Bank 62 G	SYSMON Configuration	GTY Quad 222 X1Y8-X1Y11
GTY Quad 121 X0Y4-X0Y7 L [LS] (RCAL)	ILKN X0Y0	HP I/O Bank 61 F	Configuration	GTY Quad 221 X1Y4-X1Y7 (RCAL)
GTY Quad 120 X0Y0-X0Y3 K [LS]	CMAC X0Y0	HP I/O Bank 60	PCIE4 X0Y0	GTY Quad 220 X1Y0-X1Y3

X18715-030517

Figure 1-114: XCVU13P Banks in FIGD2104 Package

GTY Quad 135 X0Y60-X0Y63 AA [LN]	CMAC X0Y11	HP I/O Bank 75 K	ILKN X1Y7	GTY Quad 235 X1Y60-X1Y63 K [RN]
GTY Quad 134 X0Y56-X0Y59 Z [LN]	CMAC X0Y10	HP I/O Bank 74 J	SYSMON Configuration	GTY Quad 234 X1Y56-X1Y59 J [RN]
GTY Quad 133 X0Y52-X0Y55 Y [LN] (RCAL)	ILKN X0Y6	HP I/O Bank 73 I	Configuration	GTY Quad 233 X1Y52-X1Y55 I [RN] (RCAL)
GTY Quad 132 X0Y48-X0Y51 X [LN]	CMAC X0Y9	HP I/O Bank 72	PCIE4 X0Y3	GTY Quad 232 X1Y48-X1Y51 H [RN]
SLR Crossing				
GTY Quad 131 X0Y44-X0Y47 W [LUC]	CMAC X0Y8	HP I/O Bank 71 H (Partial)	ILKN X1Y5	GTY Quad 231 X1Y44-X1Y47 G [RUC]
GTY Quad 130 X0Y40-X0Y43 V [LUC]	CMAC X0Y7	HP I/O Bank 70 G	SYSMON Configuration	GTY Quad 230 X1Y40-X1Y43 F [RUC]
GTY Quad 129 X0Y36-X0Y39 U [LUC] (RCAL)	ILKN X0Y4	HP I/O Bank 69	Configuration	GTY Quad 229 X1Y36-X1Y39 E [RUC] (RCAL)
GTY Quad 128 X0Y32-X0Y35 T [LUC]	CMAC X0Y6	HP I/O Bank 68	PCIE4 X0Y2	GTY Quad 228 X1Y32-X1Y35 D [RUC]
SLR Crossing				
GTY Quad 127 X0Y28-X0Y31 S [LLC]	CMAC X0Y5	HP I/O Bank 67	ILKN X1Y3	GTY Quad 227 X1Y28-X1Y31 C [RLC]
GTY Quad 126 X0Y24-X0Y27 R [LLC]	CMAC X0Y4	HP I/O Bank 66 B (Partial)	SYSMON Configuration	GTY Quad 226 X1Y24-X1Y27 B [RLC]
GTY Quad 125 X0Y20-X0Y23 Q [LLC] (RCAL)	ILKN X0Y2	HP I/O Bank 65 C	Configuration	GTY Quad 225 X1Y20-X1Y23 A [RLC] (RCAL)
GTY Quad 124 X0Y16-X0Y19 AF [LLC]	CMAC X0Y3	HP I/O Bank 64	PCIE4 X0Y1 (tandem)	GTY Quad 224 X1Y16-X1Y19 P [RLC]
SLR Crossing				
GTY Quad 123 X0Y12-X0Y15 AE [LS]	CMAC X0Y2	HP I/O Bank 63 F	ILKN X1Y1	GTY Quad 223 X1Y12-X1Y15 O [RS]
GTY Quad 122 X0Y8-X0Y11 AD [LS]	CMAC X0Y1	HP I/O Bank 62 E	SYSMON Configuration	GTY Quad 222 X1Y8-X1Y11 N [RS]
GTY Quad 121 X0Y4-X0Y7 AC [LS] (RCAL)	ILKN X0Y0	HP I/O Bank 61 D	Configuration	GTY Quad 221 X1Y4-X1Y7 M [RS] (RCAL)
GTY Quad 120 X0Y0-X0Y3 AB [LS]	CMAC X0Y0	HP I/O Bank 60	PCIE4 X0Y0	GTY Quad 220 X1Y0-X1Y3 L [RS]

X15625-020817

Figure 1-115: XCVU13P Banks in FLGA2577 and FSGA2577 Packages

XCVU27P Bank Diagrams

GTM Dual 135 X0Y11	CMAC X0Y11	HP I/O Bank 75	ILKN X1Y7	GTM Dual 235 X1Y11
GTM Dual 134 X0Y10	CMAC X0Y10	HP I/O Bank 74	SYSMON Configuration	GTM Dual 234 X1Y10
GTM Dual 133 X0Y9 (RCAL)	ILKN X0Y6	HP I/O Bank 73	Configuration	GTM Dual 233 X1Y9 (RCAL)
GTM Dual 132 X0Y8	CMAC X0Y9	HP I/O Bank 72	CMAC X0Y9	GTM Dual 232 X1Y8
SLR Crossing				
GTM Dual 131 X0Y7	CMAC X0Y8	HP I/O Bank 71	ILKN X1Y5	GTM Dual 231 X1Y7
GTM Dual 130 X0Y6	CMAC X0Y7	HP I/O Bank 70	SYSMON Configuration	GTM Dual 230 X1Y6
GTM Dual 129 X0Y5 (RCAL)	ILKN X0Y4	HP I/O Bank 69	Configuration	GTM Dual 229 X1Y5 (RCAL)
GTM Dual 128 X0Y4	CMAC X0Y6	HP I/O Bank 68	CMAC X1Y6	GTM Dual 228 X1Y4
SLR Crossing				
GTU Quad 127 X0Y12-X0Y15	CMAC X0Y5	HP I/O Bank 67	ILKN X1Y3	GTU Quad 227 X1Y12-X1Y15
GTU Quad 126 X0Y8-X0Y11	CMAC X0Y4	HP I/O Bank 66	SYSMON Configuration	GTU Quad 226 X1Y8-X1Y11
GTU Quad 125 X0Y4-X0Y7 (RCAL)	ILKN X0Y2	HP I/O Bank 65	Configuration	GTU Quad 225 X1Y4-X1Y7 (RCAL)
GTU Quad 124 X0Y0-X0Y3	CMAC X0Y3	HP I/O Bank 64	PCIE4 X0Y1 (tandem)	GTU Quad 224 X1Y0-X1Y3
SLR Crossing				
GTM Dual 123 X0Y3	CMAC X0Y2	HP I/O Bank 63	ILKN X1Y1	GTM Dual 223 X1Y3
GTM Dual 122 X0Y2	CMAC X0Y1	HP I/O Bank 62	SYSMON Configuration	GTM Dual 222 X1Y2
GTM Dual 121 X0Y1 (RCAL)	ILKN X0Y0	HP I/O Bank 61	Configuration	GTM Dual 221 X1Y1 (RCAL)
GTM Dual 120 X0Y0	CMAC X0Y0	HP I/O Bank 60	CMAC X1Y0	GTM Dual 220 X1Y0

X20507-031518

Figure 1-116: XCVU27P Banks

GTM Dual 135 X0Y11	CMAC X0Y11	HP I/O Bank 75	ILKN X1Y7	GTM Dual 235 X1Y11
GTM Dual 134 X0Y10	CMAC X0Y10	HP I/O Bank 74 O	SYSMON Configuration	GTM Dual 234 X1Y10
GTM Dual 133 X0Y9 S [LN] (RCAL)	ILKN X0Y6	HP I/O Bank 73 N	Configuration	GTM Dual 233 X1Y9 J [RN] (RCAL)
GTM Dual 132 X0Y8	CMAC X0Y9	HP I/O Bank 72 M	CMAC X0Y9	GTM Dual 232 X1Y8 I [RN]
SLR Crossing				
GTM Dual 131 X0Y7 R [LN]	CMAC X0Y8	HP I/O Bank 71 L	ILKN X1Y5	GTM Dual 231 X1Y7 H [RN]
GTM Dual 130 X0Y6 Q [LN]	CMAC X0Y7	HP I/O Bank 70 K	SYSMON Configuration	GTM Dual 230 X1Y6 G [RN]
GTM Dual 129 X0Y5 P [LN] (RCAL)	ILKN X0Y4	HP I/O Bank 69 J	Configuration	GTM Dual 229 X1Y5 F [RN] (RCAL)
GTM Dual 128 X0Y4 O [LC]	CMAC X0Y6	HP I/O Bank 68	CMAC X1Y6	GTM Dual 228 X1Y4 E [RS]
SLR Crossing				
GTU Quad 127 X0Y12-X0Y15	CMAC X0Y5	HP I/O Bank 67 E	ILKN X1Y3	GTU Quad 227 X1Y12-X1Y15 D [RS]
GTU Quad 126 X0Y8-X0Y11	CMAC X0Y4	HP I/O Bank 66 D	SYSMON Configuration	GTU Quad 226 X1Y8-X1Y11 C [RS]
GTU Quad 125 X0Y4-X0Y7 (RCAL)	ILKN X0Y2	HP I/O Bank 65 C	Configuration	GTU Quad 225 X1Y4-X1Y7 B [RS] (RCAL)
GTU Quad 124 X0Y0-X0Y3	CMAC X0Y3	HP I/O Bank 64 B	PCIE4 X0Y1 (tandem)	GTU Quad 224 X1Y0-X1Y3 A [RS]
SLR Crossing				
GTM Dual 123 X0Y3 N [LS]	CMAC X0Y2	HP I/O Bank 63 H	ILKN X1Y1	GTM Dual 223 X1Y3
GTM Dual 122 X0Y2 M [LS]	CMAC X0Y1	HP I/O Bank 62 G	SYSMON Configuration	GTM Dual 222 X1Y2
GTM Dual 121 X0Y1 L [LS] (RCAL)	ILKN X0Y0	HP I/O Bank 61 F	Configuration	GTM Dual 221 X1Y1 (RCAL)
GTM Dual 120 X0Y0 K [LS]	CMAC X0Y0	HP I/O Bank 60	CMAC X1Y0	GTM Dual 220 X1Y0

X20508-031518

Figure 1-117: XCVU27P Banks in FIGD2104 Package

GTM Dual 135 X0Y11 AA [LN]	CMAC X0Y11	HP I/O Bank 75 K	ILKN X1Y7	GTM Dual 235 X1Y11 K [RN]
GTM Dual 134 X0Y10 Z [LN]	CMAC X0Y10	HP I/O Bank 74 J	SYSMON Configuration	GTM Dual 234 X1Y10 J [RN]
GTM Dual 133 X0Y9 Y [LN] (RCAL)	ILKN X0Y6	HP I/O Bank 73 I	Configuration	GTM Dual 233 X1Y9 I [RN] (RCAL)
GTM Dual 132 X0Y8 X [LN]	CMAC X0Y9	HP I/O Bank 72	CMAC X0Y9	GTM Dual 232 X1Y8 H [RN]
SLR Crossing				
GTM Dual 131 X0Y7 W [LUC]	CMAC X0Y8	HP I/O Bank 71 H (Partial)	ILKN X1Y5	GTM Dual 231 X1Y7 G [RUC]
GTM Dual 130 X0Y6 V [LUC]	CMAC X0Y7	HP I/O Bank 70 G	SYSMON Configuration	GTM Dual 230 X1Y6 F [RUC]
GTM Dual 129 X0Y5 U [LUC] (RCAL)	ILKN X0Y4	HP I/O Bank 69	Configuration	GTM Dual 229 X1Y5 E [RUC] (RCAL)
GTM Dual 128 X0Y4 T [LUC]	CMAC X0Y6	HP I/O Bank 68	CMAC X1Y6	GTM Dual 228 X1Y4 D [RUC]
SLR Crossing				
GTU Quad 127 X0Y12-X0Y15 S [LLC]	CMAC X0Y5	HP I/O Bank 67	ILKN X1Y3	GTU Quad 227 X1Y12-X1Y15 C [RLC]
GTU Quad 126 X0Y8-X0Y11 R [LLC]	CMAC X0Y4	HP I/O Bank 66 B (Partial)	SYSMON Configuration	GTU Quad 226 X1Y8-X1Y11 B [RLC]
GTU Quad 125 X0Y4-X0Y7 Q [LLC] (RCAL)	ILKN X0Y2	HP I/O Bank 65 C	Configuration	GTU Quad 225 X1Y4-X1Y7 A [RLC] (RCAL)
GTU Quad 124 X0Y0-X0Y3 AF [LLC]	CMAC X0Y3	HP I/O Bank 64	PCIE4 X0Y1 (tandem)	GTU Quad 224 X1Y0-X1Y3 P [RLC]
SLR Crossing				
GTM Dual 123 X0Y3 AE [LS]	CMAC X0Y2	HP I/O Bank 63 F	ILKN X1Y1	GTM Dual 223 X1Y3 O [RS]
GTM Dual 122 X0Y2 AD [LS]	CMAC X0Y1	HP I/O Bank 62 E	SYSMON Configuration	GTM Dual 222 X1Y2 N [RS]
GTM Dual 121 X0Y1 AC [LS] (RCAL)	ILKN X0Y0	HP I/O Bank 61 D	Configuration	GTM Dual 221 X1Y1 M [RS] (RCAL)
GTM Dual 120 X0Y0 AB [LS]	CMAC X0Y0	HP I/O Bank 60	CMAC X1Y0	GTM Dual 220 X1Y0 L [RS]

X20509-031518

Figure 1-118: XCVU27P Banks in FSGA2577 Package

XCVU29P Bank Diagrams

GTM Dual 135 X0Y11	CMAC X0Y11	HP I/O Bank 75	ILKN X1Y7	GTM Dual 235 X1Y11
GTM Dual 134 X0Y10	CMAC X0Y10	HP I/O Bank 74	SYSMON Configuration	GTM Dual 234 X1Y10
GTM Dual 133 X0Y9 (RCAL)	ILKN X0Y6	HP I/O Bank 73	Configuration	GTM Dual 233 X1Y9 (RCAL)
GTM Dual 132 X0Y8	CMAC X0Y9	HP I/O Bank 72	CMAC X0Y9	GTM Dual 232 X1Y8
SLR Crossing				
GTM Dual 131 X0Y7	CMAC X0Y8	HP I/O Bank 71	ILKN X1Y5	GTM Dual 231 X1Y7
GTM Dual 130 X0Y6	CMAC X0Y7	HP I/O Bank 70	SYSMON Configuration	GTM Dual 230 X1Y6
GTM Dual 129 X0Y5 (RCAL)	ILKN X0Y4	HP I/O Bank 69	Configuration	GTM Dual 229 X1Y5 (RCAL)
GTM Dual 128 X0Y4	CMAC X0Y6	HP I/O Bank 68	CMAC X1Y6	GTM Dual 228 X1Y4
SLR Crossing				
GTU Quad 127 X0Y12-X0Y15	CMAC X0Y5	HP I/O Bank 67	ILKN X1Y3	GTU Quad 227 X1Y12-X1Y15
GTU Quad 126 X0Y8-X0Y11	CMAC X0Y4	HP I/O Bank 66	SYSMON Configuration	GTU Quad 226 X1Y8-X1Y11
GTU Quad 125 X0Y4-X0Y7 (RCAL)	ILKN X0Y2	HP I/O Bank 65	Configuration	GTU Quad 225 X1Y4-X1Y7 (RCAL)
GTU Quad 124 X0Y0-X0Y3	CMAC X0Y3	HP I/O Bank 64	PCIE4 X0Y1 (tandem)	GTU Quad 224 X1Y0-X1Y3
SLR Crossing				
GTM Dual 123 X0Y3	CMAC X0Y2	HP I/O Bank 63	ILKN X1Y1	GTM Dual 223 X1Y3
GTM Dual 122 X0Y2	CMAC X0Y1	HP I/O Bank 62	SYSMON Configuration	GTM Dual 222 X1Y2
GTM Dual 121 X0Y1 (RCAL)	ILKN X0Y0	HP I/O Bank 61	Configuration	GTM Dual 221 X1Y1 (RCAL)
GTM Dual 120 X0Y0	CMAC X0Y0	HP I/O Bank 60	CMAC X1Y0	GTM Dual 220 X1Y0

X20507-031518

Figure 1-119: XCVU29P Banks

GTM Dual 135 X0Y11	CMAC X0Y11	HP I/O Bank 75	ILKN X1Y7	GTM Dual 235 X1Y11
GTM Dual 134 X0Y10	CMAC X0Y10	HP I/O Bank 74 O	SYSMON Configuration	GTM Dual 234 X1Y10
GTM Dual 133 X0Y9 S [LN] (RCAL)	ILKN X0Y6	HP I/O Bank 73 N	Configuration	GTM Dual 233 X1Y9 J [RN] (RCAL)
GTM Dual 132 X0Y8	CMAC X0Y9	HP I/O Bank 72 M	CMAC X0Y9	GTM Dual 232 X1Y8 I [RN]
SLR Crossing				
GTM Dual 131 X0Y7 R [LN]	CMAC X0Y8	HP I/O Bank 71 L	ILKN X1Y5	GTM Dual 231 X1Y7 H [RN]
GTM Dual 130 X0Y6 Q [LN]	CMAC X0Y7	HP I/O Bank 70 K	SYSMON Configuration	GTM Dual 230 X1Y6 G [RN]
GTM Dual 129 X0Y5 P [LN] (RCAL)	ILKN X0Y4	HP I/O Bank 69 J	Configuration	GTM Dual 229 X1Y5 F [RN] (RCAL)
GTM Dual 128 X0Y4 O [LC]	CMAC X0Y6	HP I/O Bank 68	CMAC X1Y6	GTM Dual 228 X1Y4 E [RS]
SLR Crossing				
GTU Quad 127 X0Y12-X0Y15	CMAC X0Y5	HP I/O Bank 67 E	ILKN X1Y3	GTU Quad 227 X1Y12-X1Y15 D [RS]
GTU Quad 126 X0Y8-X0Y11	CMAC X0Y4	HP I/O Bank 66 D	SYSMON Configuration	GTU Quad 226 X1Y8-X1Y11 C [RS]
GTU Quad 125 X0Y4-X0Y7 (RCAL)	ILKN X0Y2	HP I/O Bank 65 C	Configuration	GTU Quad 225 X1Y4-X1Y7 B [RS] (RCAL)
GTU Quad 124 X0Y0-X0Y3	CMAC X0Y3	HP I/O Bank 64 B	PCIE4 X0Y1 (tandem)	GTU Quad 224 X1Y0-X1Y3 A [RS]
SLR Crossing				
GTM Dual 123 X0Y3 N [LS]	CMAC X0Y2	HP I/O Bank 63 H	ILKN X1Y1	GTM Dual 223 X1Y3
GTM Dual 122 X0Y2 M [LS]	CMAC X0Y1	HP I/O Bank 62 G	SYSMON Configuration	GTM Dual 222 X1Y2
GTM Dual 121 X0Y1 L [LS] (RCAL)	ILKN X0Y0	HP I/O Bank 61 F	Configuration	GTM Dual 221 X1Y1 (RCAL)
GTM Dual 120 X0Y0 K [LS]	CMAC X0Y0	HP I/O Bank 60	CMAC X1Y0	GTM Dual 220 X1Y0

X20508-031518

Figure 1-120: XCVU29P Banks in FIGD2104 Package

GTM Dual 135 X0Y11 AA [LN]	CMAC X0Y11	HP I/O Bank 75 K	ILKN X1Y7	GTM Dual 235 X1Y11 K [RN]
GTM Dual 134 X0Y10 Z [LN]	CMAC X0Y10	HP I/O Bank 74 J	SYSMON Configuration	GTM Dual 234 X1Y10 J [RN]
GTM Dual 133 X0Y9 Y [LN] (RCAL)	ILKN X0Y6	HP I/O Bank 73 I	Configuration	GTM Dual 233 X1Y9 I [RN] (RCAL)
GTM Dual 132 X0Y8 X [LN]	CMAC X0Y9	HP I/O Bank 72	CMAC X0Y9	GTM Dual 232 X1Y8 H [RN]
SLR Crossing				
GTM Dual 131 X0Y7 W [LUC]	CMAC X0Y8	HP I/O Bank 71 H (Partial)	ILKN X1Y5	GTM Dual 231 X1Y7 G [RUC]
GTM Dual 130 X0Y6 V [LUC]	CMAC X0Y7	HP I/O Bank 70 G	SYSMON Configuration	GTM Dual 230 X1Y6 F [RUC]
GTM Dual 129 X0Y5 U [LUC] (RCAL)	ILKN X0Y4	HP I/O Bank 69	Configuration	GTM Dual 229 X1Y5 E [RUC] (RCAL)
GTM Dual 128 X0Y4 T [LUC]	CMAC X0Y6	HP I/O Bank 68	CMAC X1Y6	GTM Dual 228 X1Y4 D [RUC]
SLR Crossing				
GTU Quad 127 X0Y12-X0Y15 S [LLC]	CMAC X0Y5	HP I/O Bank 67	ILKN X1Y3	GTU Quad 227 X1Y12-X1Y15 C [RLC]
GTU Quad 126 X0Y8-X0Y11 R [LLC]	CMAC X0Y4	HP I/O Bank 66 B (Partial)	SYSMON Configuration	GTU Quad 226 X1Y8-X1Y11 B [RLC]
GTU Quad 125 X0Y4-X0Y7 Q [LLC] (RCAL)	ILKN X0Y2	HP I/O Bank 65 C	Configuration	GTU Quad 225 X1Y4-X1Y7 A [RLC] (RCAL)
GTU Quad 124 X0Y0-X0Y3 AF [LLC]	CMAC X0Y3	HP I/O Bank 64	PCIE4 X0Y1 (tandem)	GTU Quad 224 X1Y0-X1Y3 P [RLC]
SLR Crossing				
GTM Dual 123 X0Y3 AE [LS]	CMAC X0Y2	HP I/O Bank 63 F	ILKN X1Y1	GTM Dual 223 X1Y3 O [RS]
GTM Dual 122 X0Y2 AD [LS]	CMAC X0Y1	HP I/O Bank 62 E	SYSMON Configuration	GTM Dual 222 X1Y2 N [RS]
GTM Dual 121 X0Y1 AC [LS] (RCAL)	ILKN X0Y0	HP I/O Bank 61 D	Configuration	GTM Dual 221 X1Y1 M [RS] (RCAL)
GTM Dual 120 X0Y0 AB [LS]	CMAC X0Y0	HP I/O Bank 60	CMAC X1Y0	GTM Dual 220 X1Y0 L [RS]

X20509-031518

Figure 1-121: XCVU29P Banks in FSGA2577 Package

XCVU31P Bank Diagrams

GTY Quad 127 X0Y12-X0Y15	PCIE4C X0Y1	HP I/O Bank 67	PCIE4C X1Y1	GTY Quad 227 X1Y12-X1Y15
GTY Quad 126 X0Y8-X0Y11	CMAC X0Y1	HP I/O Bank 66	SYSMON Configuration	GTY Quad 226 X1Y8-X1Y11
GTY Quad 125 X0Y4-X0Y7 (RCAL)	CMAC X0Y0	HP I/O Bank 65	Configuration	GTY Quad 225 X1Y4-X1Y7 (RCAL)
GTY Quad 124 X0Y0-X0Y3	PCIE4C X0Y0	HP I/O Bank 64	PCIE4C X1Y0	GTY Quad 224 X1Y0-X1Y3
			HBM Bank 83	

X19796-010619

Figure 1-122: XCVU31P Banks

GTY Quad 127 X0Y12-X0Y15 H [L]	PCIE4C X0Y1	HP I/O Bank 67 E	PCIE4C X1Y1	GTY Quad 227 X1Y12-X1Y15 D [R]
GTY Quad 126 X0Y8-X0Y11 G [L]	CMAC X0Y1	HP I/O Bank 66 D	SYSMON Configuration	GTY Quad 226 X1Y8-X1Y11 C [R]
GTY Quad 125 X0Y4-X0Y7 F [L] (RCAL)	CMAC X0Y0	HP I/O Bank 65 C	Configuration	GTY Quad 225 X1Y4-X1Y7 B [R] (RCAL)
GTY Quad 124 X0Y0-X0Y3 E [L]	PCIE4C X0Y0	HP I/O Bank 64 B	PCIE4C X1Y0	GTY Quad 224 X1Y0-X1Y3 A [R]
			HBM Bank 83	

X19797-010619

Figure 1-123: XCVU31P Banks in FSVH1924 Package

XCVU33P Bank Diagrams

GTY Quad 127 X0Y12-X0Y15	PCIE4C X0Y1	HP I/O Bank 67	PCIE4C X1Y1	GTY Quad 227 X1Y12-X1Y15
GTY Quad 126 X0Y8-X0Y11	CMAC X0Y1	HP I/O Bank 66	SYSMON Configuration	GTY Quad 226 X1Y8-X1Y11
GTY Quad 125 X0Y4-X0Y7 (RCAL)	CMAC X0Y0	HP I/O Bank 65	Configuration	GTY Quad 225 X1Y4-X1Y7 (RCAL)
GTY Quad 124 X0Y0-X0Y3	PCIE4C X0Y0	HP I/O Bank 64	PCIE4C X1Y0	GTY Quad 224 X1Y0-X1Y3
	HBM Bank 43		HBM Bank 83	

X19798-010619

Figure 1-124: XCVU33P Banks

GTY Quad 127 X0Y12-X0Y15 L [LS]	PCIE4C X0Y1	HP I/O Bank 67 G	PCIE4C X1Y1	GTY Quad 227 X1Y12-X1Y15 D [RS]
GTY Quad 126 X0Y8-X0Y11 K [LS]	CMAC X0Y1	HP I/O Bank 66 D	SYSMON Configuration	GTY Quad 226 X1Y8-X1Y11 C [RS]
GTY Quad 125 X0Y4-X0Y7 J [LS] (RCAL)	CMAC X0Y0	HP I/O Bank 65 C	Configuration	GTY Quad 225 X1Y4-X1Y7 B [RS] (RCAL)
GTY Quad 124 X0Y0-X0Y3 I [LS]	PCIE4C X0Y0	HP I/O Bank 64 B	PCIE4C X1Y0	GTY Quad 224 X1Y0-X1Y3 A [RS]
	HBM Bank 43		HBM Bank 83	

X19799-010619

Figure 1-125: XCVU33P Banks in FSVH2104 Package

XCVU35P Bank Diagrams

GTY Quad 131 X0Y28-X0Y31	CMAC X0Y4	HP I/O Bank 71	ILKN X1Y1	GTY Quad 231 X1Y28-X1Y31
GTY Quad 130 X0Y24-X0Y27	CMAC X0Y3	HP I/O Bank 70	SYSMON Configuration	GTY Quad 230 X1Y24-X1Y27
GTY Quad 129 X0Y20-X0Y23 (RCAL)	ILKN X0Y0	HP I/O Bank 69	Configuration	GTY Quad 229 X1Y20-X1Y23 (RCAL)
GTY Quad 128 X0Y16-X0Y19	CMAC X0Y2	HP I/O Bank 68	PCIE4 X0Y0	GTY Quad 228 X1Y16-X1Y19
SLR Crossing				
GTY Quad 127 X0Y12-X0Y15	PCIE4C X0Y1	HP I/O Bank 67	PCIE4C X1Y1	GTY Quad 227 X1Y12-X1Y15
GTY Quad 126 X0Y8-X0Y11	CMAC X0Y1	HP I/O Bank 66	SYSMON Configuration	GTY Quad 226 X1Y8-X1Y11
GTY Quad 125 X0Y4-X0Y7 (RCAL)	CMAC X0Y0	HP I/O Bank 65	Configuration	GTY Quad 225 X1Y4-X1Y7 (RCAL)
GTY Quad 124 X0Y0-X0Y3	PCIE4C X0Y0	HP I/O Bank 64	PCIE4C X1Y0	GTY Quad 224 X1Y0-X1Y3
	HBM Bank 43		HBM Bank 83	

X19800-010619

Figure 1-126: XCVU35P Banks

GTY Quad 131 X0Y28-X0Y31 P [LN]	CMAC X0Y4	HP I/O Bank 71 K	ILKN X1Y1	GTY Quad 231 X1Y28-X1Y31 H [RN]
GTY Quad 130 X0Y24-X0Y27 O [LN]	CMAC X0Y3	HP I/O Bank 70 J	SYSMON Configuration	GTY Quad 230 X1Y24-X1Y27 G [RN]
GTY Quad 129 X0Y20-X0Y23 N [LN] (RCAL)	ILKN X0Y0	HP I/O Bank 69 I	Configuration	GTY Quad 229 X1Y20-X1Y23 F [RN] (RCAL)
GTY Quad 128 X0Y16-X0Y19 M [LN]	CMAC X0Y2	HP I/O Bank 68 H	PCIE4 X0Y0	GTY Quad 228 X1Y16-X1Y19 E [RN]
SLR Crossing				
GTY Quad 127 X0Y12-X0Y15 L [LS]	PCIE4C X0Y1	HP I/O Bank 67 G	PCIE4C X1Y1	GTY Quad 227 X1Y12-X1Y15 D [RS]
GTY Quad 126 X0Y8-X0Y11 K [LS]	CMAC X0Y1	HP I/O Bank 66 D	SYSMON Configuration	GTY Quad 226 X1Y8-X1Y11 C [RS]
GTY Quad 125 X0Y4-X0Y7 J [LS] (RCAL)	CMAC X0Y0	HP I/O Bank 65 C	Configuration	GTY Quad 225 X1Y4-X1Y7 B [RS] (RCAL)
GTY Quad 124 X0Y0-X0Y3 I [LS]	PCIE4C X0Y0	HP I/O Bank 64 B	PCIE4C X1Y0	GTY Quad 224 X1Y0-X1Y3 A [RS]
	HBM Bank 43		HBM Bank 83	

X19801-010619

Figure 1-127: XCVU35P Banks in FSVH2104 Package

GTY Quad 131 X0Y28-X0Y31 T [LC]	CMAC X0Y4	HP I/O Bank 71 J	ILKN X1Y1	GTY Quad 231 X1Y28-X1Y31 H [RC]
GTY Quad 130 X0Y24-X0Y27 S [LC]	CMAC X0Y3	HP I/O Bank 70 I	SYSMON Configuration	GTY Quad 230 X1Y24-X1Y27 G [RC]
GTY Quad 129 X0Y20-X0Y23 R [LC] (RCAL)	ILKN X0Y0	HP I/O Bank 69 G	Configuration	GTY Quad 229 X1Y20-X1Y23 F [RC] (RCAL)
GTY Quad 128 X0Y16-X0Y19 Q [LC]	CMAC X0Y2	HP I/O Bank 68 F	PCIE4 X0Y0	GTY Quad 228 X1Y16-X1Y19 E [RC]
SLR Crossing				
GTY Quad 127 X0Y12-X0Y15 P [LS]	PCIE4C X0Y1	HP I/O Bank 67 E	PCIE4C X1Y1	GTY Quad 227 X1Y12-X1Y15 D [RS]
GTY Quad 126 X0Y8-X0Y11 O [LS]	CMAC X0Y1	HP I/O Bank 66 D	SYSMON Configuration	GTY Quad 226 X1Y8-X1Y11 C [RS]
GTY Quad 125 X0Y4-X0Y7 N [LS] (RCAL)	CMAC X0Y0	HP I/O Bank 65 C	Configuration	GTY Quad 225 X1Y4-X1Y7 B [RS] (RCAL)
GTY Quad 124 X0Y0-X0Y3 M [LS]	PCIE4C X0Y0	HP I/O Bank 64 B	PCIE4C X1Y0	GTY Quad 224 X1Y0-X1Y3 A [RS]
	HBM Bank 43		HBM Bank 83	

X19802-010619

Figure 1-128: XCVU35P Banks in FSVH2892 Package

XCVU37P Bank Diagrams

GTY Quad 135 X0Y44-X0Y47	CMAC X0Y7	HP I/O Bank 75	ILKN X1Y3	GTY Quad 235 X1Y44-X1Y47
GTY Quad 134 X0Y40-X0Y43	CMAC X0Y6	HP I/O Bank 74	SYSMON Configuration	GTY Quad 234 X1Y40-X1Y43
GTY Quad 133 X0Y36-X0Y39 (RCAL)	ILKN X0Y2	HP I/O Bank 73	Configuration	GTY Quad 233 X1Y36-X1Y39 (RCAL)
GTY Quad 132 X0Y32-X0Y35	CMAC X0Y5	HP I/O Bank 72	PCIE4 X0Y1	GTY Quad 232 X1Y32-X1Y35
SLR Crossing				
GTY Quad 131 X0Y28-X0Y31	CMAC X0Y4	HP I/O Bank 71	ILKN X1Y1	GTY Quad 231 X1Y28-X1Y31
GTY Quad 130 X0Y24-X0Y27	CMAC X0Y3	HP I/O Bank 70	SYSMON Configuration	GTY Quad 230 X1Y24-X1Y27
GTY Quad 129 X0Y20-X0Y23 (RCAL)	ILKN X0Y0	HP I/O Bank 69	Configuration	GTY Quad 229 X1Y20-X1Y23 (RCAL)
GTY Quad 128 X0Y16-X0Y19	CMAC X0Y2	HP I/O Bank 68	PCIE4 X0Y0	GTY Quad 228 X1Y16-X1Y19
SLR Crossing				
GTY Quad 127 X0Y12-X0Y15	PCIE4C X0Y1	HP I/O Bank 67	PCIE4C X1Y1	GTY Quad 227 X1Y12-X1Y15
GTY Quad 126 X0Y8-X0Y11	CMAC X0Y1	HP I/O Bank 66	SYSMON Configuration	GTY Quad 226 X1Y8-X1Y11
GTY Quad 125 X0Y4-X0Y7 (RCAL)	CMAC X0Y0	HP I/O Bank 65	Configuration	GTY Quad 225 X1Y4-X1Y7 (RCAL)
GTY Quad 124 X0Y0-X0Y3	PCIE4C X0Y0	HP I/O Bank 64	PCIE4C X1Y0	GTY Quad 224 X1Y0-X1Y3
	HBM Bank 43		HBM Bank 83	

X19803-010619

Figure 1-129: XCVU37P Banks

GTY Quad 135 X0Y44-X0Y47 X [LN]	CMAC X0Y7	HP I/O Bank 75 N	ILKN X1Y3	GTY Quad 235 X1Y44-X1Y47 L [RN]
GTY Quad 134 X0Y40-X0Y43 W [LN]	CMAC X0Y6	HP I/O Bank 74 M	SYSMON Configuration	GTY Quad 234 X1Y40-X1Y43 K [RN]
GTY Quad 133 X0Y36-X0Y39 V [LN] (RCAL)	ILKN X0Y2	HP I/O Bank 73 L	Configuration	GTY Quad 233 X1Y36-X1Y39 J [RN] (RCAL)
GTY Quad 132 X0Y32-X0Y35 U [LN]	CMAC X0Y5	HP I/O Bank 72 K	PCIE4 X0Y1	GTY Quad 232 X1Y32-X1Y35 I [RN]
SLR Crossing				
GTY Quad 131 X0Y28-X0Y31 T [LC]	CMAC X0Y4	HP I/O Bank 71 J	ILKN X1Y1	GTY Quad 231 X1Y28-X1Y31 H [RC]
GTY Quad 130 X0Y24-X0Y27 S [LC]	CMAC X0Y3	HP I/O Bank 70 I	SYSMON Configuration	GTY Quad 230 X1Y24-X1Y27 G [RC]
GTY Quad 129 X0Y20-X0Y23 R [LC] (RCAL)	ILKN X0Y0	HP I/O Bank 69 G	Configuration	GTY Quad 229 X1Y20-X1Y23 F [RC] (RCAL)
GTY Quad 128 X0Y16-X0Y19 Q [LC]	CMAC X0Y2	HP I/O Bank 68 F	PCIE4 X0Y0	GTY Quad 228 X1Y16-X1Y19 E [RC]
SLR Crossing				
GTY Quad 127 X0Y12-X0Y15 P [LS]	PCIE4C X0Y1	HP I/O Bank 67 E	PCIE4C X1Y1	GTY Quad 227 X1Y12-X1Y15 D [RS]
GTY Quad 126 X0Y8-X0Y11 O [LS]	CMAC X0Y1	HP I/O Bank 66 D	SYSMON Configuration	GTY Quad 226 X1Y8-X1Y11 C [RS]
GTY Quad 125 X0Y4-X0Y7 N [LS] (RCAL)	CMAC X0Y0	HP I/O Bank 65 C	Configuration	GTY Quad 225 X1Y4-X1Y7 B [RS] (RCAL)
GTY Quad 124 X0Y0-X0Y3 M [LS]	PCIE4C X0Y0	HP I/O Bank 64 B	PCIE4C X1Y0	GTY Quad 224 X1Y0-X1Y3 A [RS]
	HBM Bank 43		HBM Bank 83	

X19804-010619

Figure 1-130: XCVU37P Banks in FSVH2892 Package

Package Files

About ASCII Package Files

The ASCII package files for each package include a comma-separated-values (CSV) version and a text version optimized for a browser or text editor in fixed-width fonts. The information in each of the files includes:

- Device/Package name (*family-device-package*), with date and time of creation
- Seven columns containing data for each pin:
 - Pin—Pin location on the package.
 - Pin Name—The name of the assigned pin.
 - Memory Byte Group—Memory byte group between 0 and 3 split into upper (U) and lower (L) halves. For more information on the memory byte group, see the *UltraScale Architecture FPGAs Memory IP Product Guide* (PG150) [Ref 13].
 - Bank—Bank number.
 - I/O Type—CONFIG, HD, HR, HP, or GT (GTH, GTY, or GTM) depending on the I/O type. For more information on the I/O type, see the *UltraScale Architecture SelectIO Resources User Guide* (UG571) [Ref 5].
 - Super Logic Region—Number corresponding to the super logic region (SLR) in the devices implemented with stacked silicon interconnect (SSI) technology.
 - No-Connect—This list of devices is used for migration between devices that have the same package size and are not connected at that specific pin.
- Total number of pins in the package.

Package Specifications Designations

Package specifications are designated as evaluation only, engineering sample, or production. Each designation is defined as follows.

Evaluation Only

These package specifications are based on initial device specifications, package routability analysis and mechanical package construction. Package specifications with this designation are not stable and package pinouts are likely to change and these specifications should only be used for initial system level design feasibility.

Engineering Sample

These package specifications are based on a released package design and validated with ES engineering sample (ES) devices. Package specifications with this designation are considered stable, however some pinout and mechanical specifications might change prior to the production release of the particular device. Package pinouts with this designation are to be used for PCB and Vivado designs using ES devices.

Production

These package specifications are released coincident with production release of a particular device. Customers receive formal notification of any subsequent changes.

ASCII Pinout Files

Links to the ASCII pinout information by device/package are listed in [Table 2-1](#). The pinouts of XQ devices are identical to the pinouts of their equivalent XC devices in footprint compatible package. Links in this table to XQ devices open the XC version of the pinout file. For example, the link to RBA676-XQKU040 opens the FBVA676-XCKU040 pinout file.

Download all available Kintex UltraScale, Kintex UltraScale+, Virtex UltraScale, and Virtex UltraScale+ FPGA package/device/pinout files at:

www.xilinx.com/support/package-pinout-files/ultrascale-pkgs.html

Note: All package files are ASCII files in TXT and CSV file format. Only the available files listed in [Table 2-1](#) are linked and consolidated in this ZIP file.

www.xilinx.com/support/packagefiles/usapackages/usaall.zip



IMPORTANT: All packages are available with eutectic BGA balls. To order these packages, the device type starts with an XQ vs. XC, and the third digit in the package name is Q (for example: FFQA1156).

Table 2-1: Package/Device Pinout Files

Package	Device		
FBVA676	XCKU035 Production	XCKU040 Production	
FFVA676	XCKU3P Production	XCKU5P Production	
FFVB676	XCKU3P Production	XCKU5P Production	
FFRB676	XQKU5P Production		
RBA676	XQKU040 Production		
SFVA784	XCKU035 Production	XCKU040 Production	
SFVB784	XCKU3P Production	XCKU5P Production	
SFRB784	XQKU5P Production		
FBVA900	XCKU035 Production	XCKU040 Production	
FFVD900	XCKU3P Production	XCKU5P Production	XCKU11P Production

Table 2-1: Package/Device Pinout Files (Cont'd)

Package	Device						
FFVE900	XCKU9P Production	XCKU13P Production					
FFVA1156	XCKU025 Production	XCKU035 Production	XCKU040 Production	XCKU060 Production	XCKU095 Production	XCKU11P Production	XCKU15P Production
FFRA1156	XQKU15P Production						
RFA1156	XQKU040 Production	XQKU060 Production	XQKU095 Production				
FFVA1517	XCKU060 Production						
FLVA1517	XCKU085 Production	XCKU115 Production					
FFVC1517	XCKU095 Production	XCVU065 Production	XCVU080 Production	XCVU095 Production	XCVU3P Production		
FFRC1517	XQVU3P Production						
FFVD1517	XCVU080 Production	XCVU095 Production					
FLVD1517	XCKU115 Production	XCVU125 Production					
FFVE1517	XCKU11P Production	XCKU15P Production					
FFRE1517	XQKU15P Production						
RLD1517	XQKU115 Production						
FFVA1760	XCKU15P Production						
FFVB1760	XCKU095 Production	XCVU080 Production	XCVU095 Production				
FLVB1760	XCKU085 Production	XCKU115 Production	XCVU125 Production				
FFVE1760	XCKU15P Production						
FLVD1924	XCKU115 Production						

Table 2-1: Package/Device Pinout Files (Cont'd)

Package	Device				
FLVF1924	XCKU085 Production	XCKU115 Production			
FLGF1924	XCVU11P Production				
RLF1924	XQKU115 Production				
FSVH1924	XCVU31P Production				
FFVA2104	XCVU080 Production	XCVU095 Production			
FLVA2104	XCKU115 Production	XCVU125 Production	XCVU5P Production	XCVU7P Production	
FLRA2104	XQVU7P Production				
FLGA2104	XCVU9P Production				
FHGA2104	XCVU13P Production				
FFVB2104	XCKU095 Production	XCVU080 Production	XCVU095 Production		
FLVB2104	XCKU115 Production	XCVU125 Production	XCVU5P Production	XCVU7P Production	
FLRB2104	XQVU7P Production				
FLGB2104	XCVU160 Production	XCVU190 Production	XCVU9P Production	XCVU11P Production	
FHGB2104	XCVU13P Production				
FFVC2104	XCVU095 Production				
FLVC2104	XCVU125 Production	XCVU5P Production	XCVU7P Production		
FLGC2104	XCVU160 Production	XCVU190 Production	XCVU9P Production	XCVU11P Production	
FLRC2104	XQVU11P Production				

Table 2-1: Package/Device Pinout Files (Cont'd)

Package	Device						
FHGC2104	XCVU13P Production						
FIGD2104	XCVU13P Production	XCVU27P Engineering Sample	XCVU29P Engineering Sample				
FSGD2104	XCVU9P Production	XCVU11P Production					
FSVH2104	XCVU33P Production	XCVU35P Production					
FLGB2377	XCVU440 Production						
FLGA2577	XCVU190 Production	XCVU9P Production	XCVU11P Production	XCVU13P Production			
FSGA2577	XCVU13P Production	XCVU27P Engineering Sample	XCVU27P Engineering Sample				
FLGA2892	XCVU440 Production						
FSVH2892	XCVU35P Production	XCVU37P Production					

Device Diagrams

Summary

The diagrams in this chapter show a top-view perspective of the package pinout of each UltraScale and UltraScale+ device/package combination. [Table 3-1](#) through [Table 3-4](#) contain cross references to the device diagrams. The I/O-bank diagram shows the location of each user I/O and GTH/GTY transceiver and the respective bank or GT quad. The configuration-power diagram shows the location of every power pin and dedicated as well as multi-function configuration pin in the package. See [Package Specifications Designations in Chapter 2](#) for definitions of [Evaluation Only](#), [Engineering Sample](#), and [Production](#) device diagrams.



IMPORTANT: All packages are available with eutectic BGA balls. To order these packages, the device type starts with an XQ vs. XC, and the third digit in the package name is Q (for example: FFQA1156).

Table 3-1: Cross-Reference to Kintex UltraScale and XQ Kintex UltraScale Device Diagrams by Package

Package	Footprint Compatible Devices					Package Status
FBVA676	XCKU035 page 183	XCKU040 page 183				Production
RBA676	XQKU040 page 183					Production
SFVA784	XCKU035 page 185	XCKU040 page 185				Production
FBVA900	XCKU035 page 187	XCKU040 page 187				Production
FFVA1156	XCKU025 page 189	XCKU035 page 191	XCKU040 page 193	XCKU060 page 195	XCKU095 page 197	Production
RFA1156	XQKU040 page 193	XQKU060 page 195	XQKU095 page 197			Production
FFVA1517	XCKU060 page 199					Production

Table 3-1: Cross-Reference to Kintex UltraScale and XQ Kintex UltraScale Device Diagrams by Package (Cont'd)

Package	Footprint Compatible Devices			Package Status
FLVA1517	XCKU085 page 201	XCKU115 page 201		Production
FFVC1517	XCKU095 page 203			Production
FLVD1517	XCKU115 page 205			Production
RLD1517	XQKU115 page 205			Production
FFVB1760	XCKU095 page 207			Production
FLVB1760	XCKU085 page 209	XCKU115 page 211		Production
FLVD1924	XCKU115 page 213			Production
FLVF1924	XCKU085 page 215	XCKU115 page 217		Production
RLF1924	XQKU115 page 217			Production
FLVA2104	XCKU115 page 219			Production
FFVB2104	XCKU095 page 221			Production
FLVB2104	XCKU115 page 223			Production

Table 3-2: Cross-Reference to Virtex UltraScale Device Diagrams by Package

Package	Footprint Compatible Devices			Package Status
FFVC1517	XCVU065 page 225	XCVU080 page 227	XCVU095 page 227	Production
FFVD1517	XCVU080 page 229	XCVU095 page 229		Production
FLVD1517	XCVU125 page 231			Production
FFVB1760	XCVU080 page 233	XCVU095 page 233		Production
FLVB1760	XCVU125 page 235			Production
FFVA2104	XCVU080 page 237	XCVU095 page 237		Production
FLVA2104	XCVU125 page 239			Production
FFVB2104	XCVU080 page 241	XCVU095 page 241		Production
FLVB2104	XCVU125 page 243			Production
FLGB2104	XCVU160 page 245	XCVU190 page 245		Production
FFVC2104	XCVU095 page 247			Production
FLVC2104	XCVU125 page 249			Production
FLGC2104	XCVU160 page 251	XCVU190 page 251		Production
FLGB2377	XCVU440 page 253			Production
FLGA2577	XCVU190 page 255			Production
FLGA2892	XCVU440 page 257			Production

Table 3-3: Cross-Reference to Kintex UltraScale+ and XQ Kintex UltraScale+ Device Diagrams by Package

Package	Footprint Compatible Devices			Package Status
FFVA676	XCKU3P page 259	XCKU5P page 259		Production
FFVB676	XCKU3P page 261	XCKU5P page 261		Production
FFRB676	XQKU5P page 261			Production
SFVB784	XCKU3P page 263	XCKU5P page 263		Production
SFRB784	XQKU5P page 263			Production
FFVD900	XCKU3P page 265	XCKU5P page 265	XCKU11P page 267	Production
FFVE900	XCKU9P page 269	XCKU13P page 271		Production
FFVA1156	XCKU11P page 273	XCKU15P page 275		Production
FFRA1156	XQKU15P page 275			Production
FFVE1517	XCKU11P page 277	XCKU15P page 279		Production
FFRE1517	XQKU15P page 279			Production
FFVA1760	XCKU15P page 281			Production
FFVE1760	XCKU15P page 283			Production

Table 3-4: Cross-Reference to Virtex UltraScale+ and XQ Virtex UltraScale+ Device Diagrams by Package

Package	Footprint Compatible Devices		Package Status
FFVC1517	XCVU3P page 285		Production
FFRC1517	XQVU3P page 285		Production
FLGF1924	XCVU11P page 287		Production
FVSH1924	XCVU31P page 289		Production
FLVA2104	XCVU5P page 291	XCVU7P page 291	Production
FFRA2104	XQVU7P page 291		Production
FLGA2104	XCVU9P page 293		Production
FHGA2104	XCVU13P page 295		Production
FLVB2104	XCVU5P page 297	XCVU7P page 297	Production
FLRB2104	XQVU7P page 297		Production
FLGB2104	XCVU9P page 299	XCVU11P page 301	Production
FHGB2104	XCVU13P page 303		Production
FLVC2104	XCVU5P page 305	XCVU7P page 305	Production
FLGC2104	XCVU9P page 307	XCVU11P page 309	Production
FLRC2104	XQVU11P page 309		Production
FHGC2104	XCVU13P page 311		Production
FSGD2104	XCVU9P page 313	XCVU11P page 315	Production

Table 3-4: Cross-Reference to Virtex UltraScale+ and XQ Virtex UltraScale+ Device Diagrams by Package (Cont'd)

Package	Footprint Compatible Devices			Package Status
FIGD2104	XCVU13P page 317			Production
FIGD2104	XCVU27P page 319	XCVU29P page 321		Engineering Sample
FSVH2104	XCVU33P page 323	XCVU35P page 325		Production
FLGA2577	XCVU9P page 327	XCVU11P page 329	XCVU13P page 331	Production
FSGA2577	XCVU13P page 331			Production
FSGA2577	XCVU27P page 333	XCVU29P page 335		Engineering Sample
FSVH2892	XCVU35P page 337	XCVU37P page 339		Production

FBVA676 Package—XCKU035 and XCKU040 and RBA676 Package—XQKU040

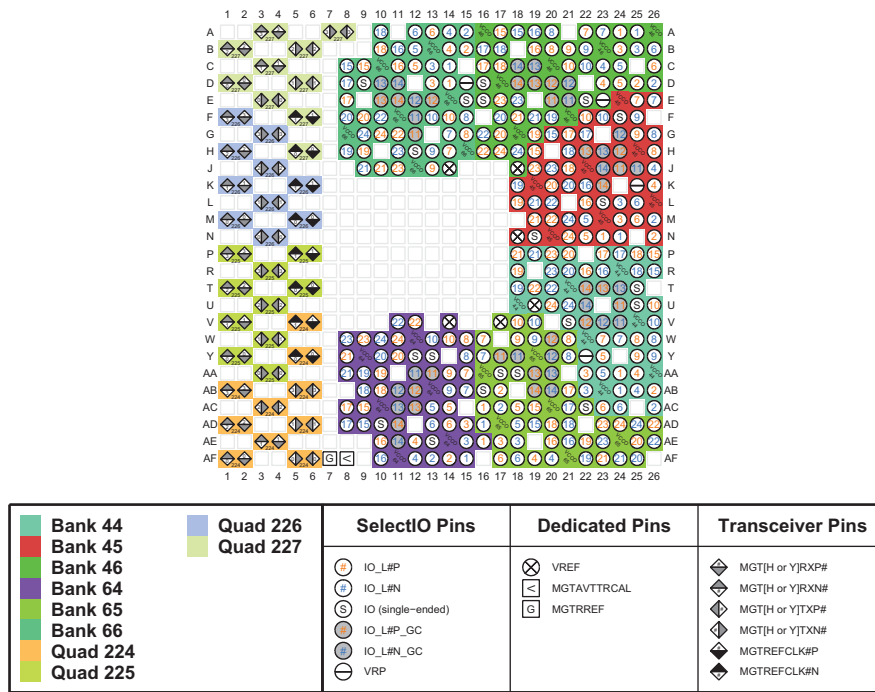

ug575_c3_01_071314

Figure 3-1: FBVA676 Package—XCKU035 and XCKU040 and RBA676 Package—XQKU040 I/O Bank Diagram

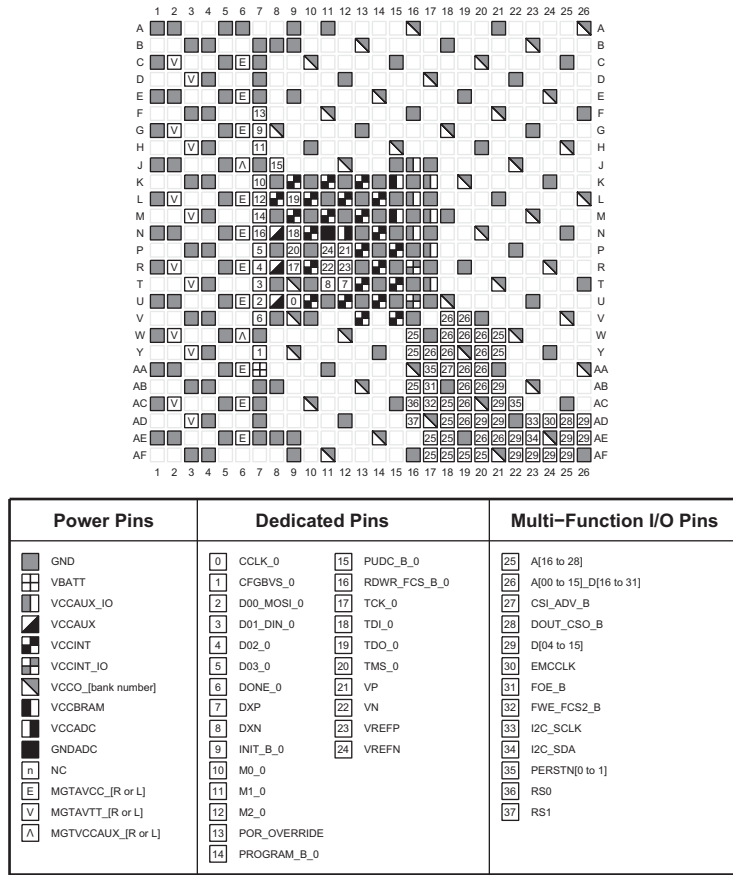

ug575_c3_02_071314

Figure 3-2: FBVA676 Package—XCKU035 and XCKU040 and RBA676 Package—XQKU040 Configuration/Power Diagram

SFVA784 (XCKU035 and XCKU040)

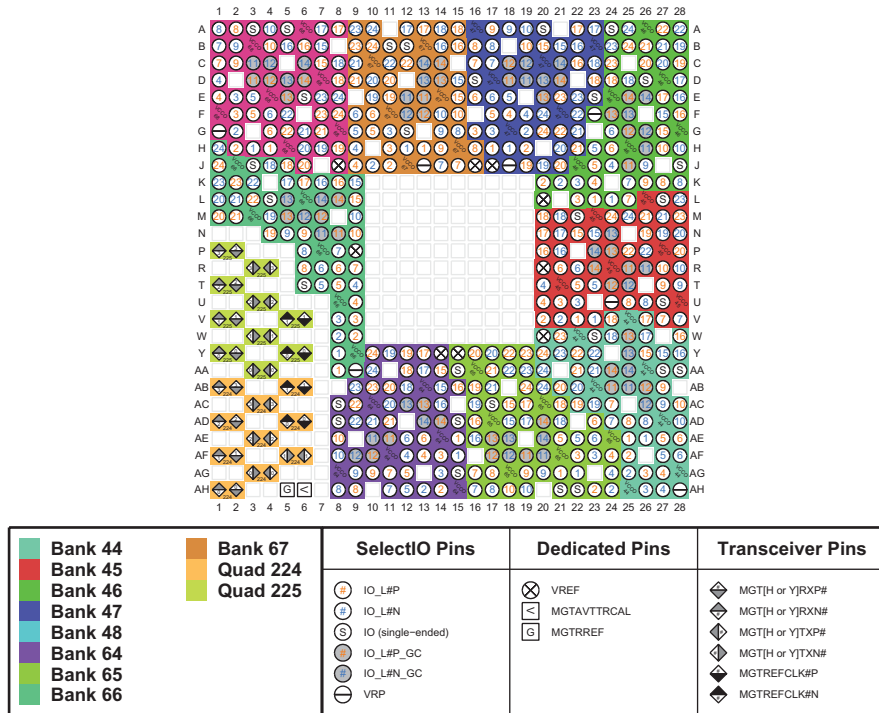

ug575_c3_03_070615

Figure 3-3: SFVA784 Package—XCKU035 and XCKU040 I/O Bank Diagram

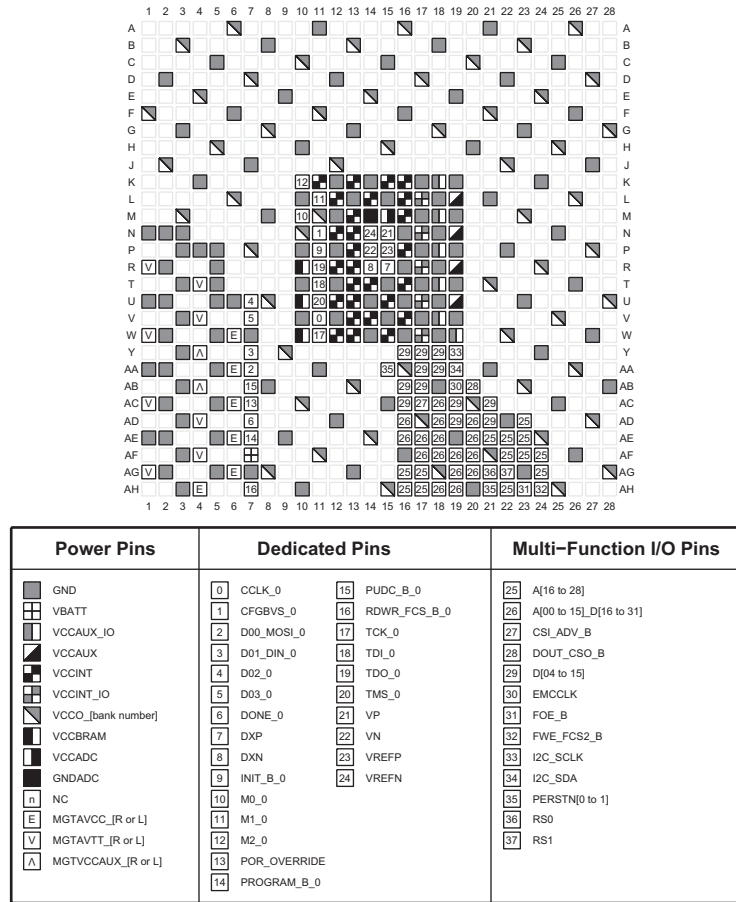

ug575_c3_04_070615

Figure 3-4: SFVA784 Package—XCKU035 and XCKU040 Configuration/Power Diagram

FBVA900 (XCKU035 and XCKU040)

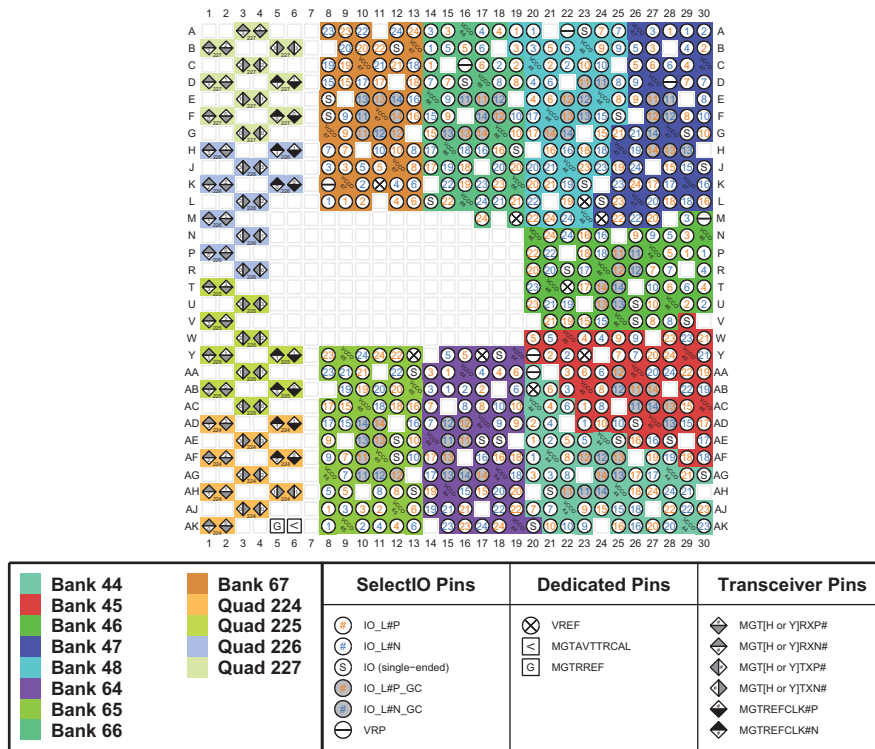

ug575_c3_05_100715

Figure 3-5: FBVA900 Package—XCKU035 and XCKU040 I/O Bank Diagram

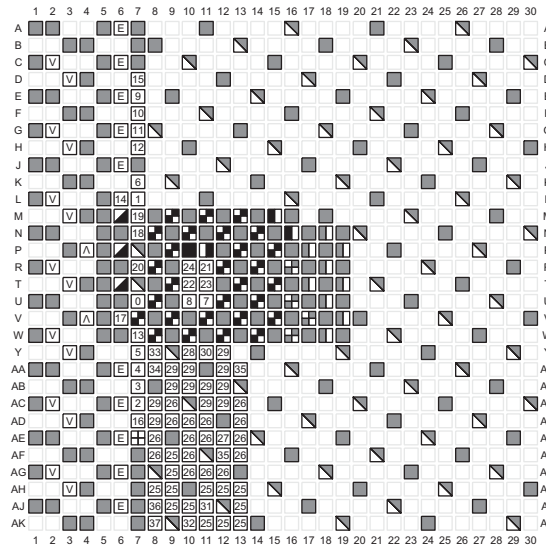

Power Pins	Dedicated Pins	Multi-Function I/O Pins
GND	0 CCLK_0	25 A[16 to 28]
VBATT	1 CFGBVS_0	26 A[00 to 15]_D[16 to 31]
VCCAUX_IO	2 D00_MOSI_0	27 CSI_ADV_B
VCCAUX	3 D01_DIN_0	28 DOUT_CSO_B
VCCINT	4 D02_0	29 D[04 to 15]
VCCINT_IO	5 D03_0	30 EMCCLK
VCCO_[bank number]	6 DONE_0	31 FOE_B
VCCBRAM	7 DXP	32 FWE_FCS2_B
VCCADC	8 DXN	33 I2C_SCLK
GNDADC	9 INIT_B_0	34 I2C_SDA
n NC	10 M0_0	35 PERSTN[0 to 1]
E MGTAVCC_[R or L]	11 M1_0	36 RS0
V MGTAVTT_[R or L]	12 M2_0	37 RS1
A MGTVCCAUX_[R or L]	13 POR_OVERRIDE	
	14 PROGRAM_B_0	
	15 PUDC_B_0	
	16 RDWR_FCS_B_0	
	17 TCK_0	
	18 TDI_0	
	19 TDO_0	
	20 TMS_0	
	21 VP	
	22 VN	
	23 VREFP	
	24 VREFN	

ug575_c3_06_100715

Figure 3-6: FBVA900 Package—XCKU035 and XCKU040 Configuration/Power Diagram

FFVA1156 (XCKU025)

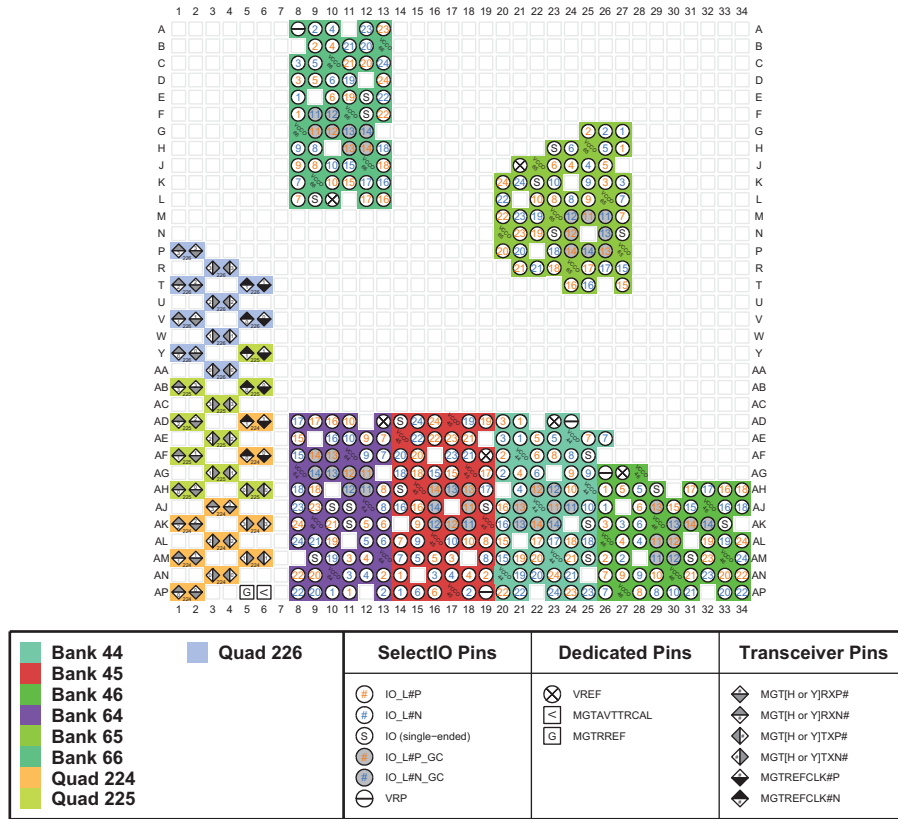

ug575_c3_07_032416

Figure 3-7: FFVA1156 Package—XCKU025 I/O Bank Diagram

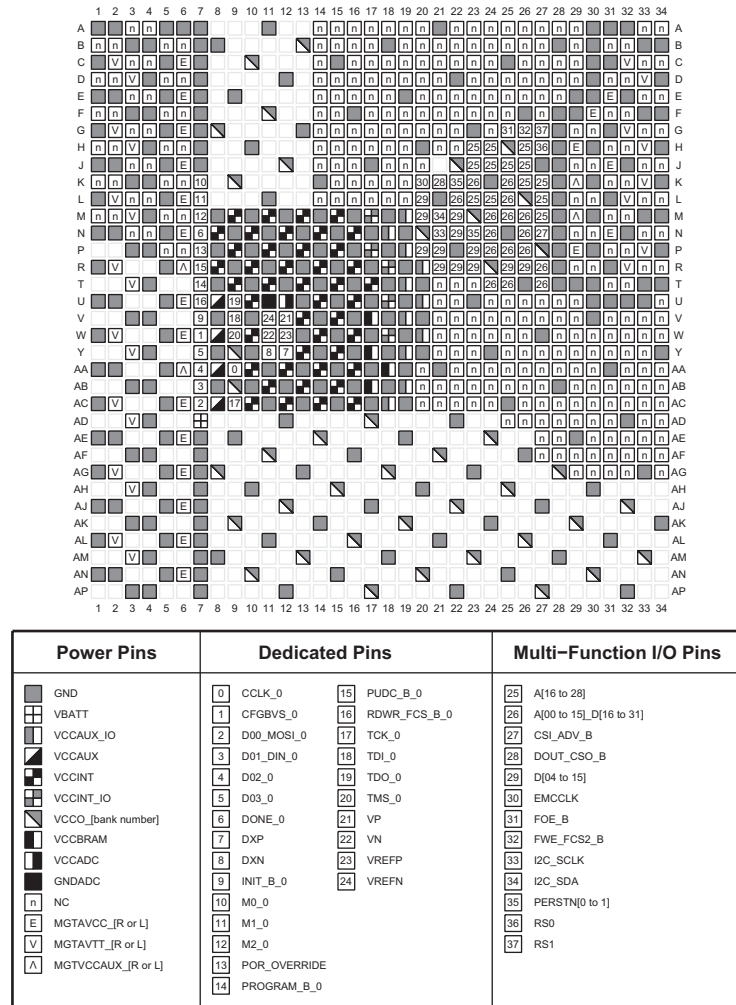

ug575_c3_08_032416

Figure 3-8: FFVA1156 Package—XCKU025 Configuration/Power Diagram

FFVA1156 (XCKU035)

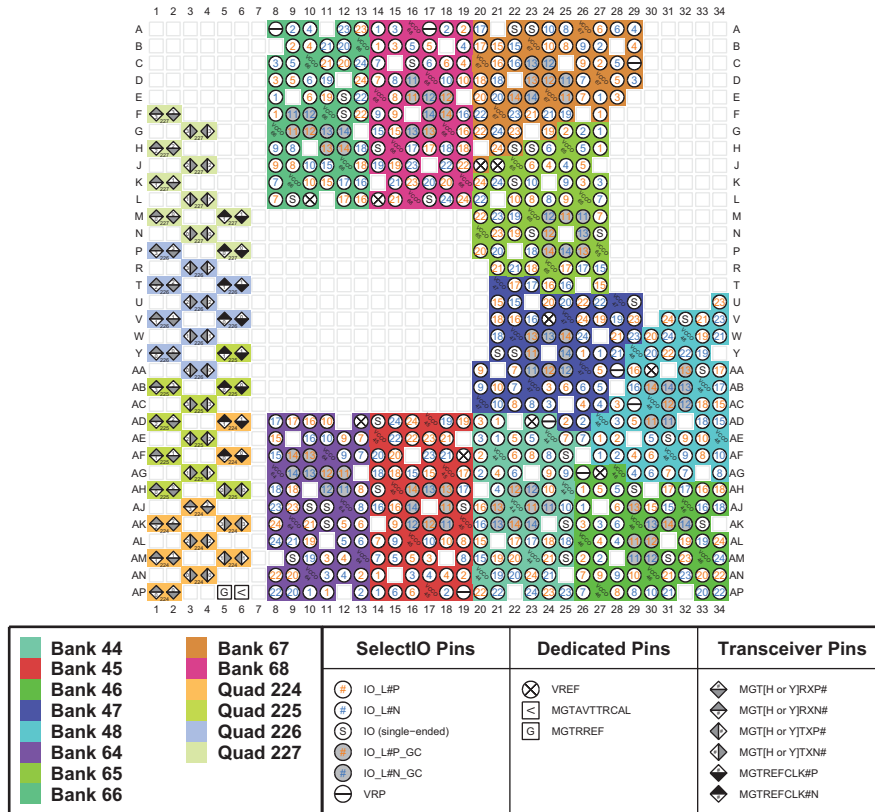

ug575_c3_09_100715

Figure 3-9: FFVA1156 Package—XCKU035 I/O Bank Diagram

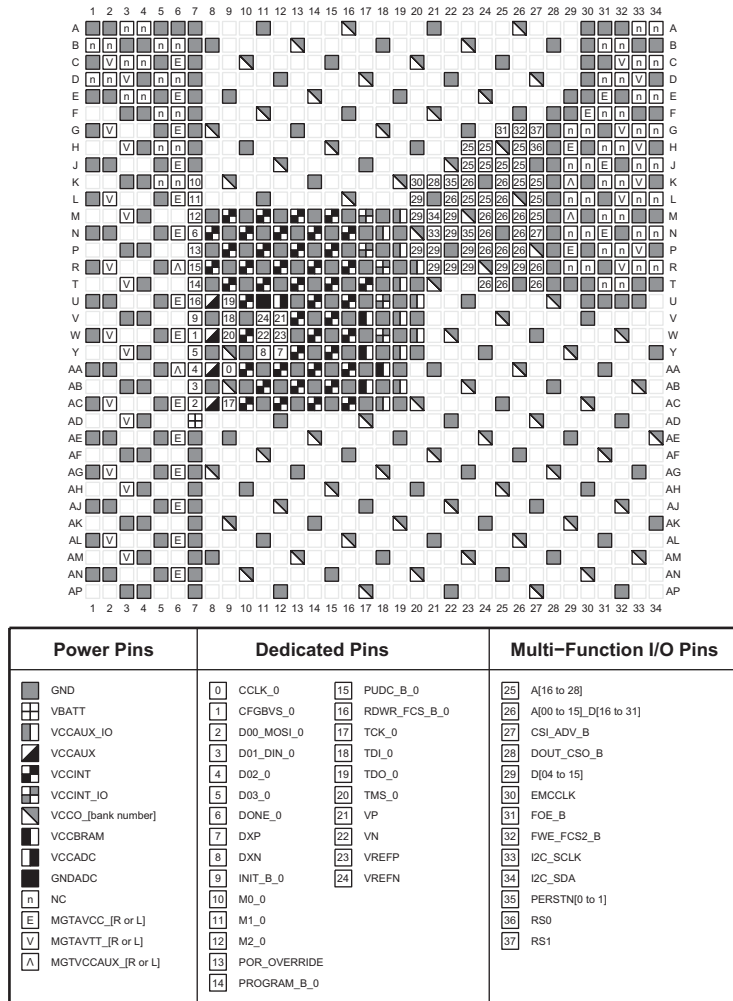

ug575_c3_10_100715

Figure 3-10: FFVA1156 Package—XCKU035 Configuration/Power Diagram

FFVA1156 (XCKU040) and RFA1156 (XQKU040)

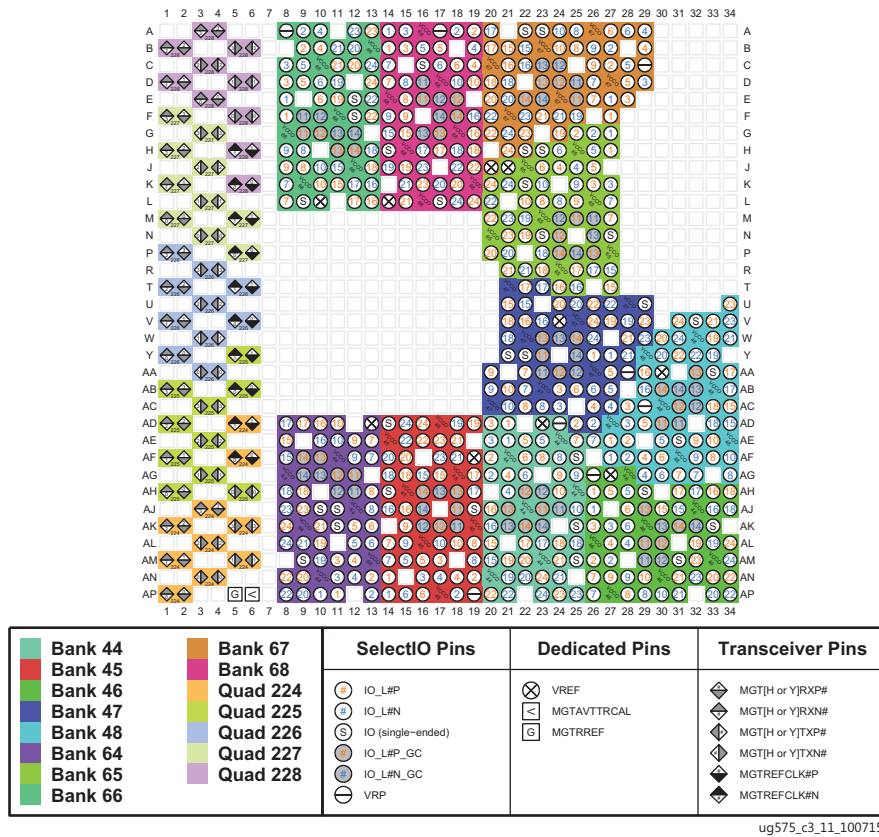
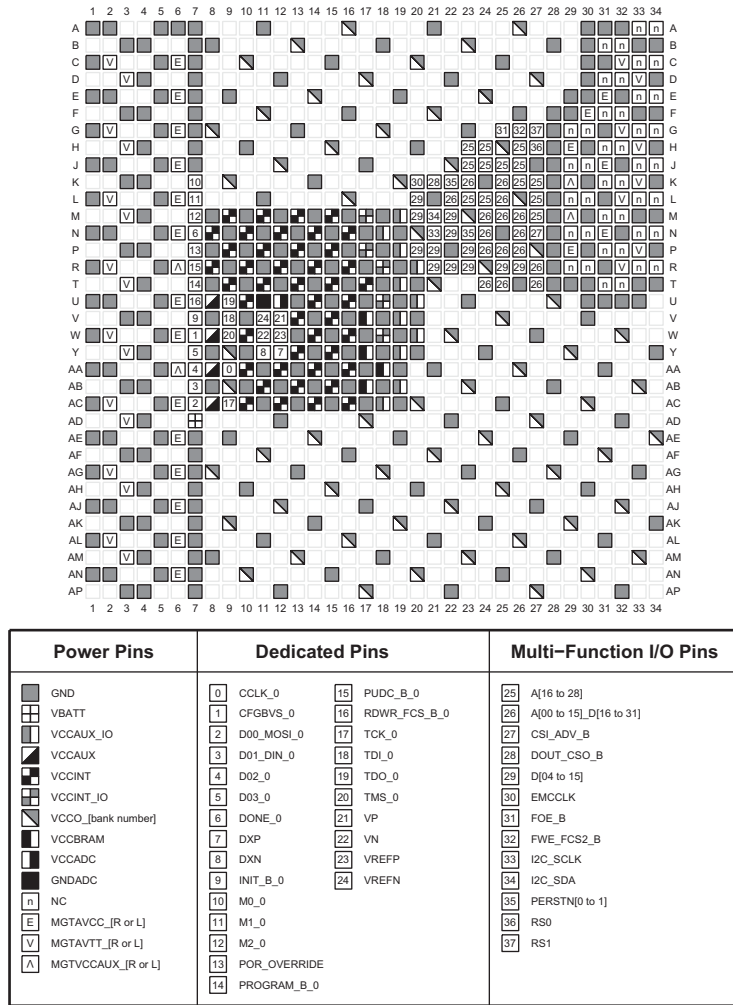

Figure 3-11: FFVA1156 Package—XCKU040 and RFA1156 Package—XQKU040 I/O Bank Diagram



ug575_c3_12_100715

Figure 3-12: FFVA1156 Package—XCKU040 and RFA1156 Package—XQKU040 Configuration/Power Diagram

FFVA1156 (XCKU060) and RFA1156 (XQKU060)

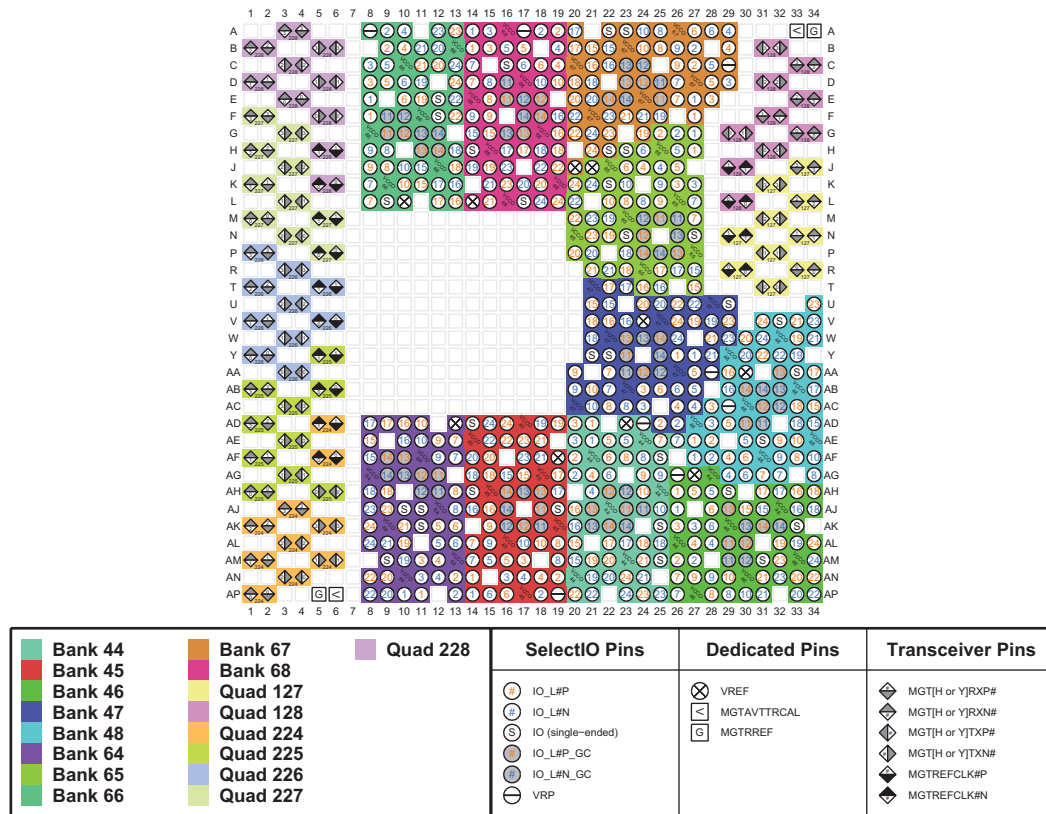

ug575_c3_13_100715

Figure 3-13: FFVA1156 Package—XCKU060 and RFA1156 Package—XQKU060 I/O Bank Diagram

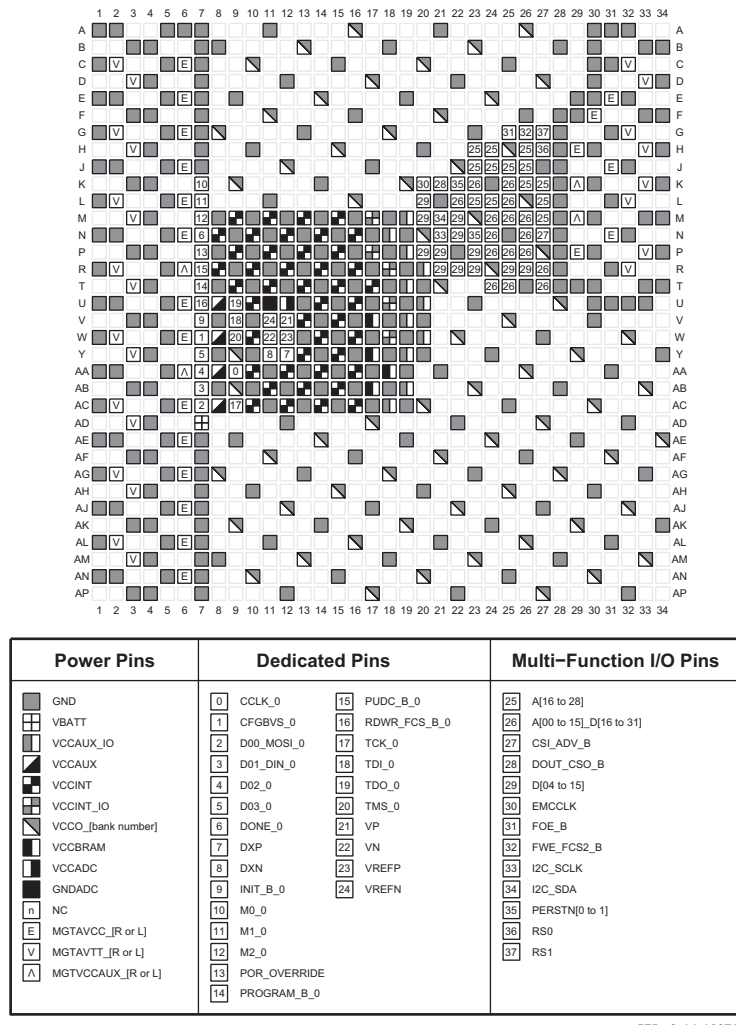

ug575_c3_14_100715

Figure 3-14: FFVA1156 Package—XCKU060 and RFA1156 Package—XQKU060 Configuration/Power Diagram

FFVA1156 (XCKU095) and RFA1156 (XQKU095)

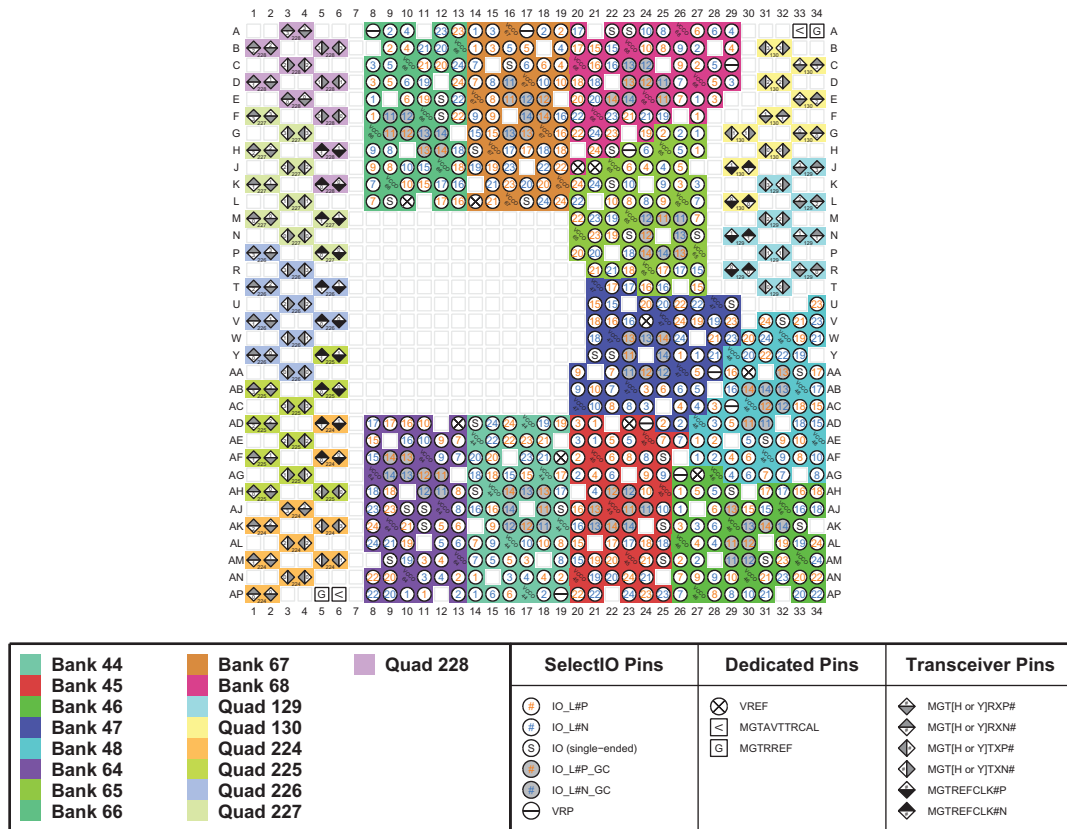

ug575_c3_15_100715

Figure 3-15: FFVA1156 Package—XCKU095 and RFA1156 Package—XQKU095 I/O Bank Diagram

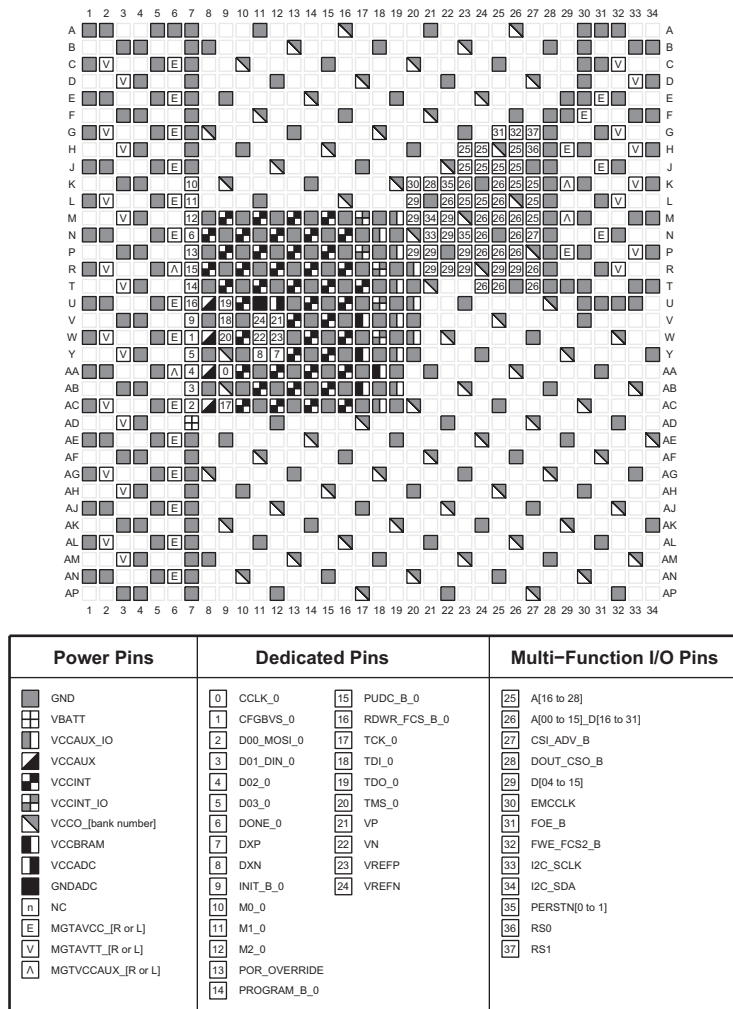

ug575_c3_16_100715

Figure 3-16: FFVA1156 Package—XCKU095 and RFA1156 Package—XQKU095 Configuration/Power Diagram

FFVA1517 (XCKU060)

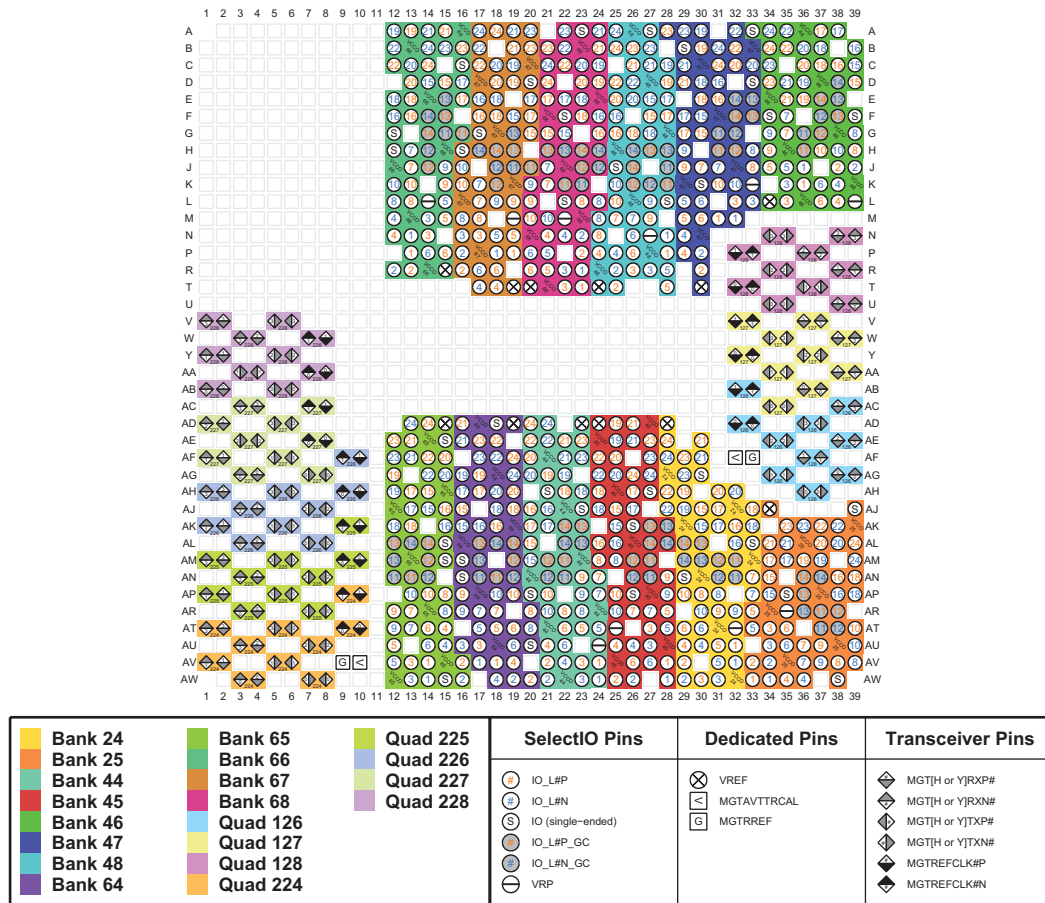

ug575_c3_17_100715

Figure 3-17: FFVA1517 Package—XCKU060 I/O Bank Diagram

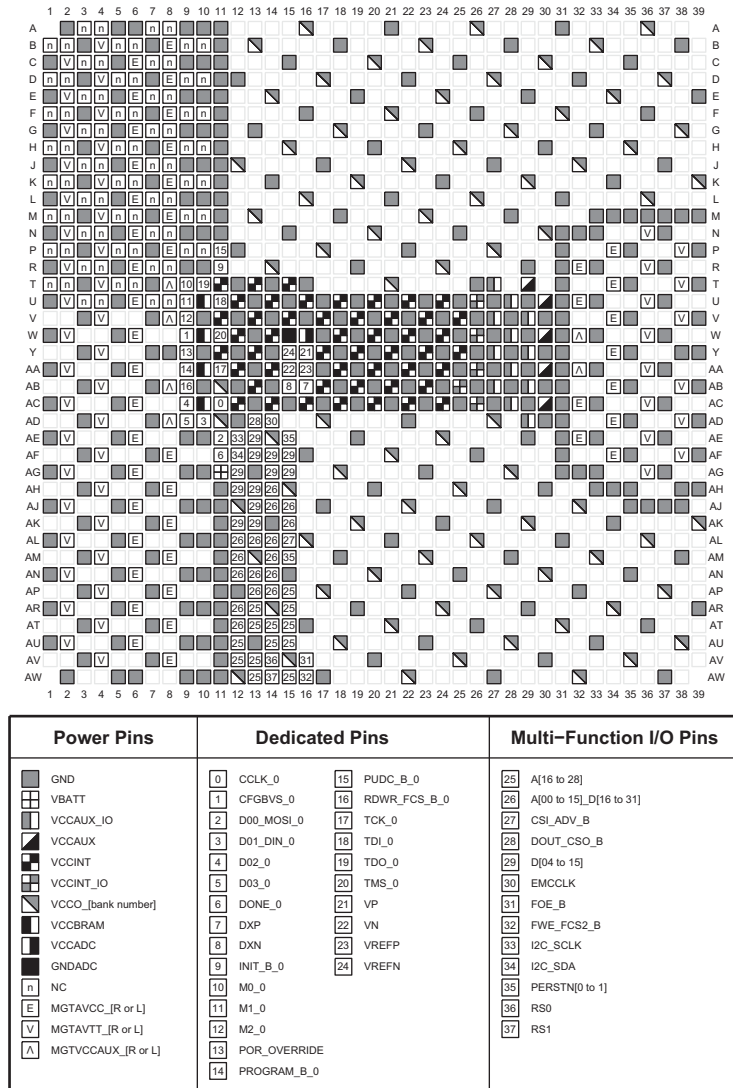

ug575_c3_18_100715

Figure 3-18: FFVA1517 Package—XCKU060 Configuration/Power Diagram

FLVA1517 (XCKU085 and XCKU115)

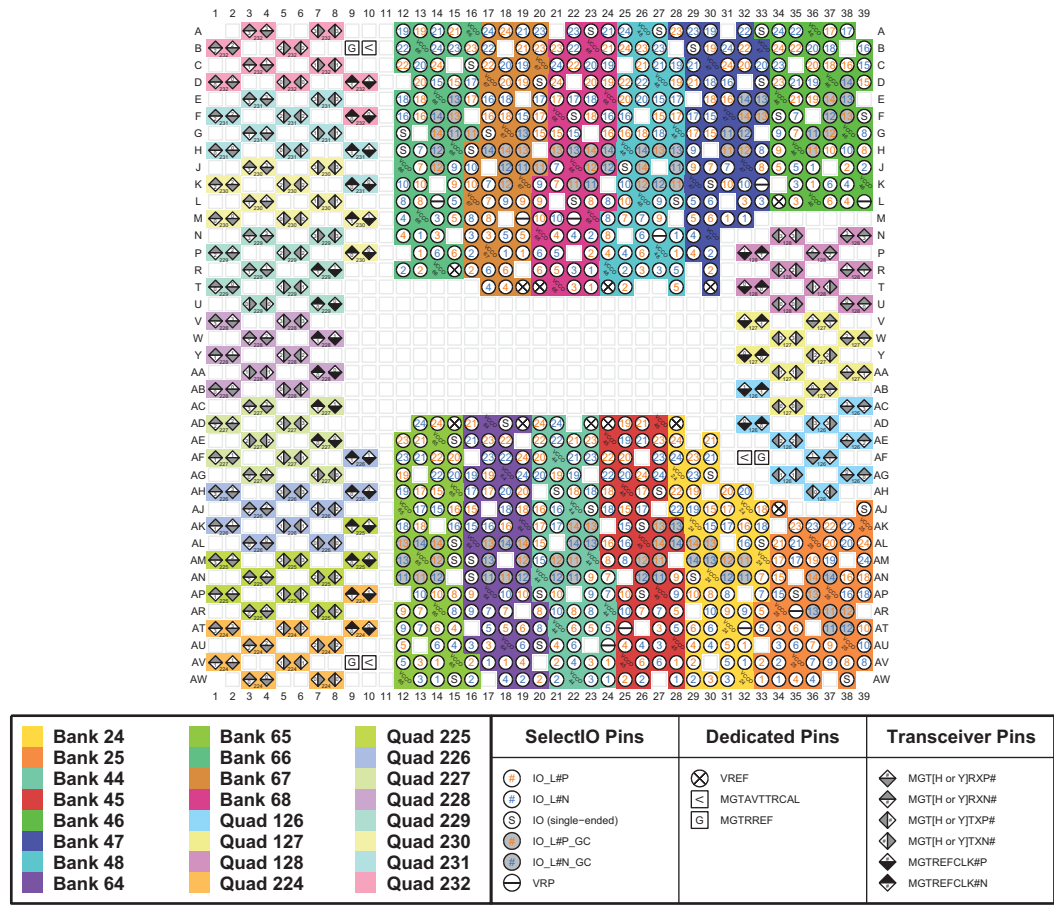
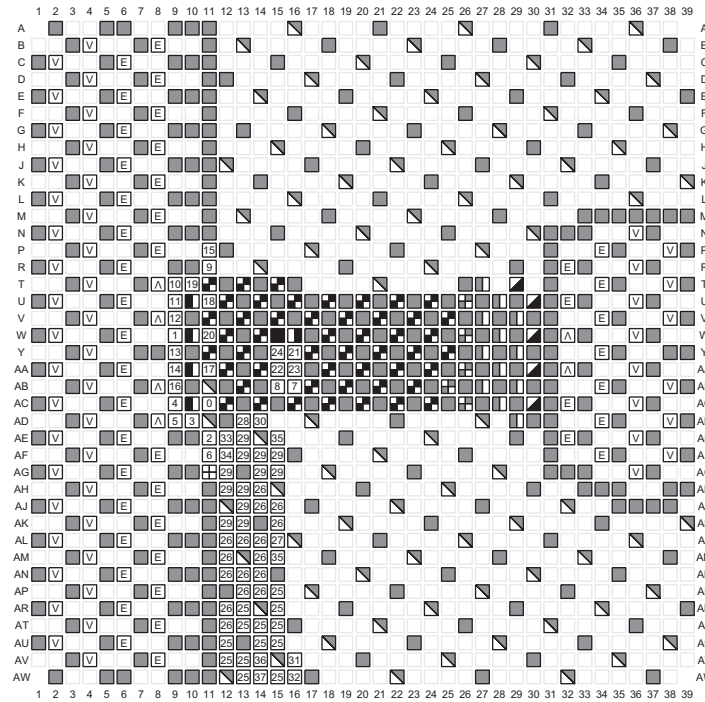

Figure 3-19: FLVA1517 Package—XCKU085 and XCKU115 I/O Bank Diagram



Power Pins	Dedicated Pins	Multi-Function I/O Pins
GND	0 CCLK_0	25 A[16 to 28]
VBATT	1 CFGBVS_0	26 A[00 to 15]_D[16 to 31]
VCCAUX_IO	2 D00_MOSI_0	27 CSI_ADV_B
VCCAUX	3 D01_DIN_0	28 DOUT_CSO_B
VCCINT	4 D02_0	29 D[04 to 15]
VCCINT_IO	5 D03_0	30 EMCCLK
VCCO_[bank number]	6 DONE_0	31 FOE_B
VCCBRAM	7 DXP	32 FWE_FCS2_B
VCCADC	8 DXN	33 I2C_SCLK
GNDADC	9 INIT_B_0	34 I2C_SDA
NC	10 M0_0	35 PERSTN[0 to 1]
MGTAUVCC_[R or L]	11 M1_0	36 RS0
MGTAUITT_[R or L]	12 M2_0	37 RS1
MGTVCCAUX_[R or L]	13 POR_OVERRIDE	
	14 PROGRAM_B_0	
	15 PUDC_B_0	
	16 RDWR_FCS_B_0	
	17 TCK_0	
	18 TDI_0	
	19 TDO_0	
	20 TMS_0	
	21 VP	
	22 VN	
	23 VREFP	
	24 VREFN	

ug575_c3_20_100715

Figure 3-20: FLVA1517 Package—XCKU085 and XCKU115 Configuration/Power Diagram

FFVC1517 (XCKU095)

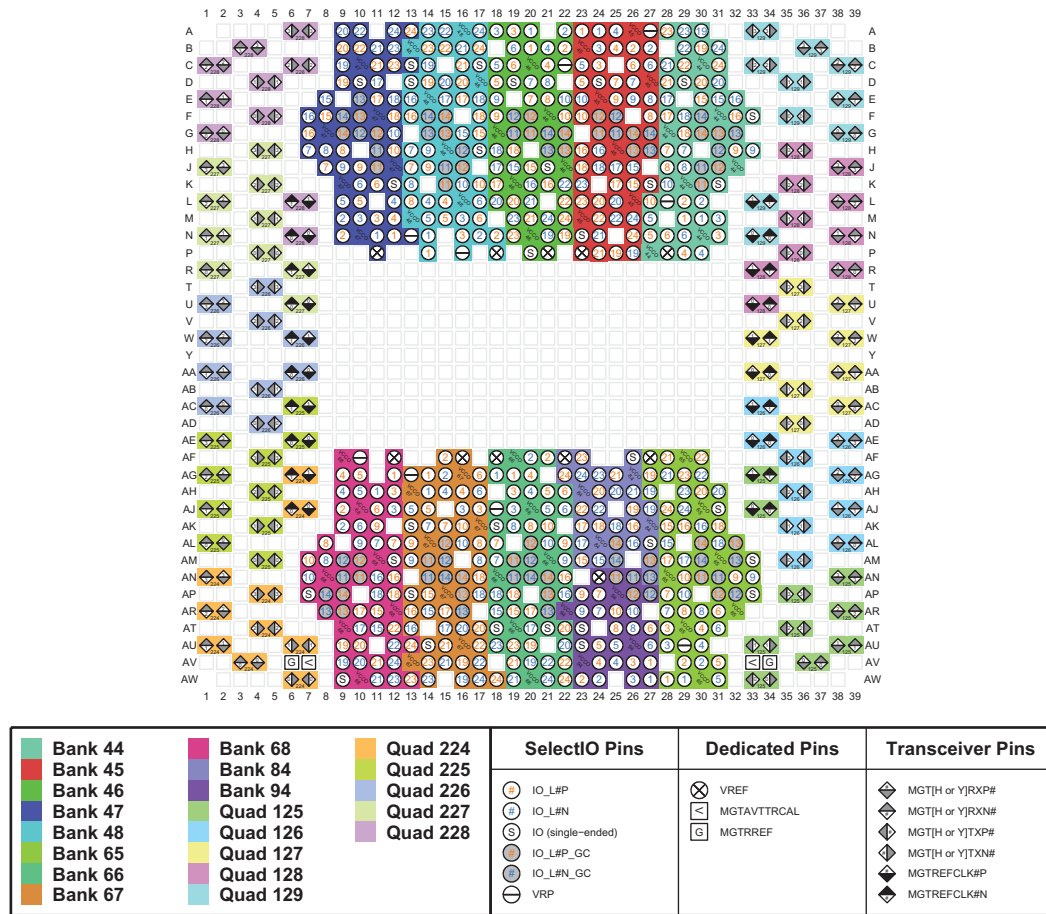

ug575_c3_21_100715

Figure 3-21: FFVC1517 Package—XCKU095 I/O Bank Diagram

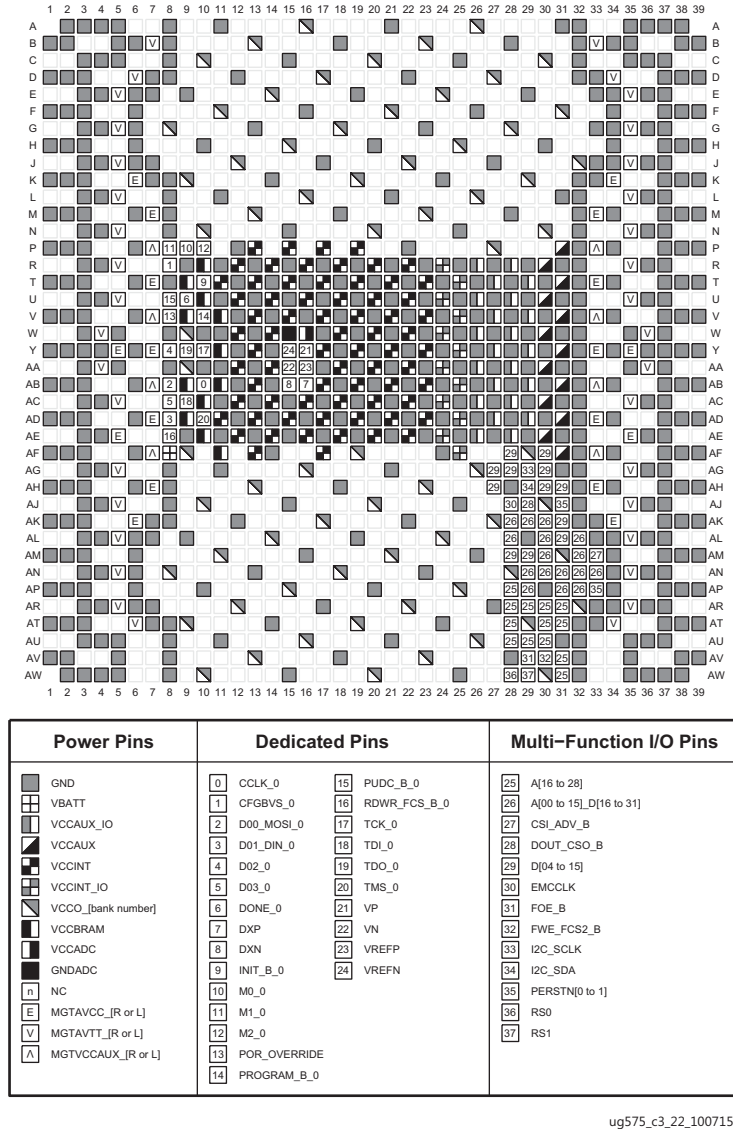

ug575_c3_22_100715

Figure 3-22: FFVC1517 Package—XCKU095 Configuration/Power Diagram

FLVD1517 (XCKU115) and RLD1517 (XQKU115)

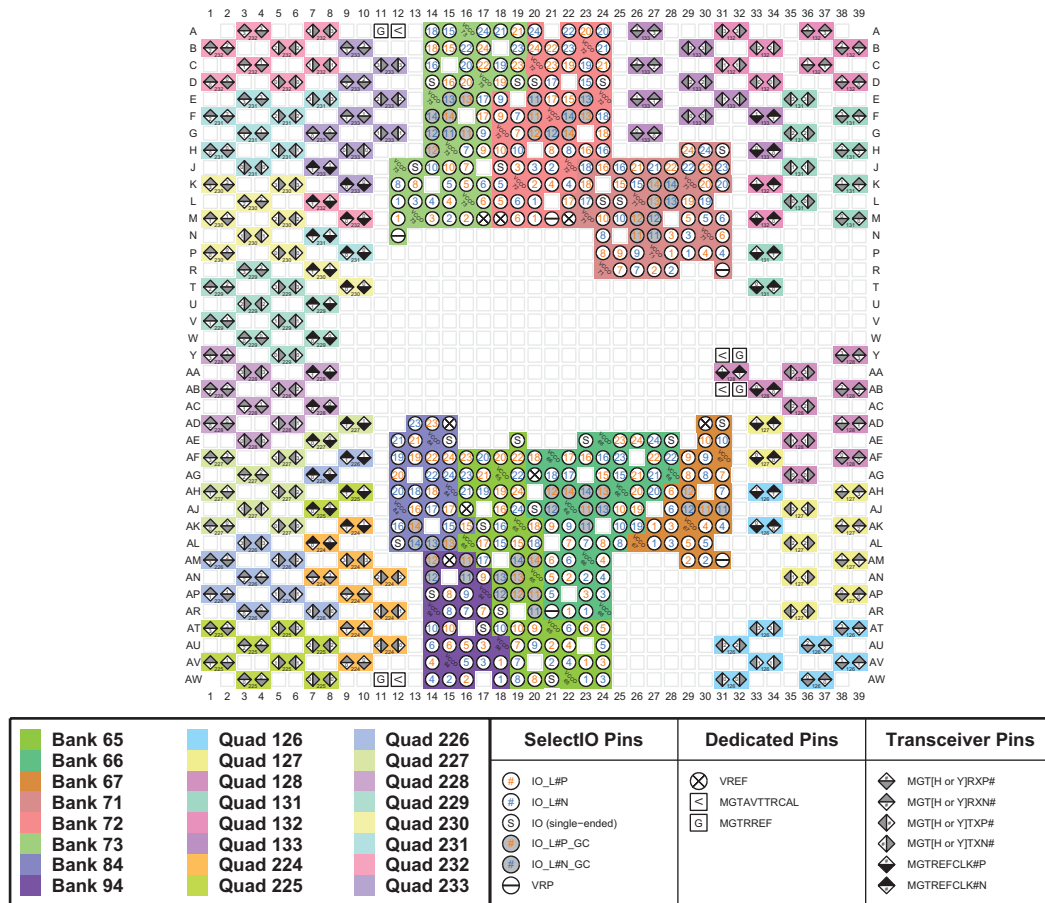

ug575_c3_23_100715

Figure 3-23: FLVD1517 Package—XCKU115 and RLD1517 Package—XQKU115 I/O Bank Diagram

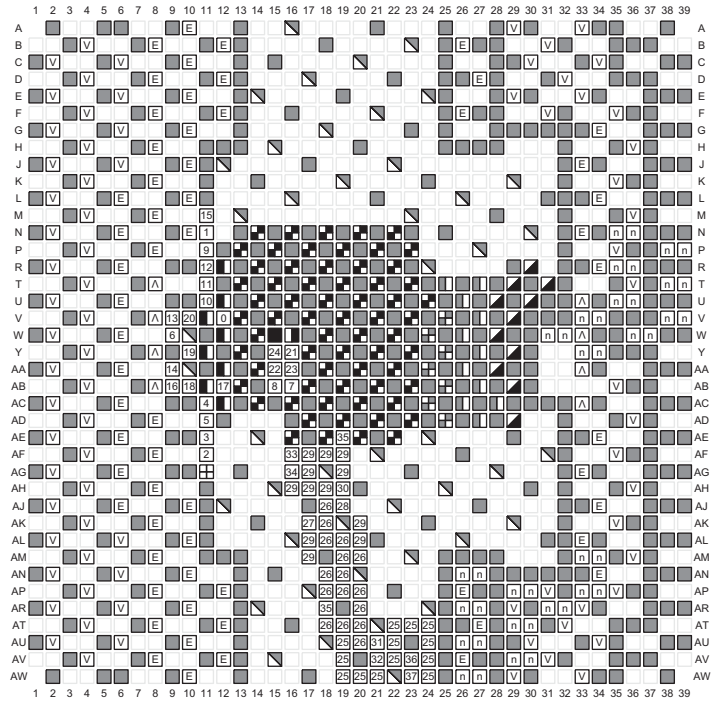

Power Pins	Dedicated Pins		Multi-Function I/O Pins
GND	0 CCLK_0	15 PUDC_B_0	25 A[16 to 28]
VBATT	1 CFGBVS_0	16 RDWR_FCS_B_0	26 A[00 to 15]_D[16 to 31]
VCCAUX_IO	2 D00_MOSI_0	17 TCK_0	27 CSI_ADV_B
VCCAUX	3 D01_DIN_0	18 TDI_0	28 DOUT_CSO_B
VCCINT	4 D02_0	19 TDO_0	29 D[04 to 15]
VCCINT_IO	5 D03_0	20 TMS_0	30 EMCCLK
VCCO_bank numberj	6 DONE_0	21 VP	31 FOE_B
VCCBRAM	7 DXP	22 VN	32 FWE_FCS2_B
VCCADC	8 DXN	23 VREFP	33 I2C_SCLK
GNDADC	9 INIT_B_0	24 VREFN	34 I2C_SDA
n NC	10 M0_0		35 PERSTN[0 to 1]
E MGTAVCC_[R or L]	11 M1_0		36 RS0
V MGTAVTT_[R or L]	12 M2_0		37 RS1
A MGTVCCAUX_[R or L]	13 POR_OVERRIDE		
	14 PROGRAM_B_0		

ug575_c3_24_100715

Figure 3-24: FLVD1517 Package—XCKU115 and RLD1517 Package—XQKU115 Configuration/Power Diagram

FFVB1760 (XCKU095)

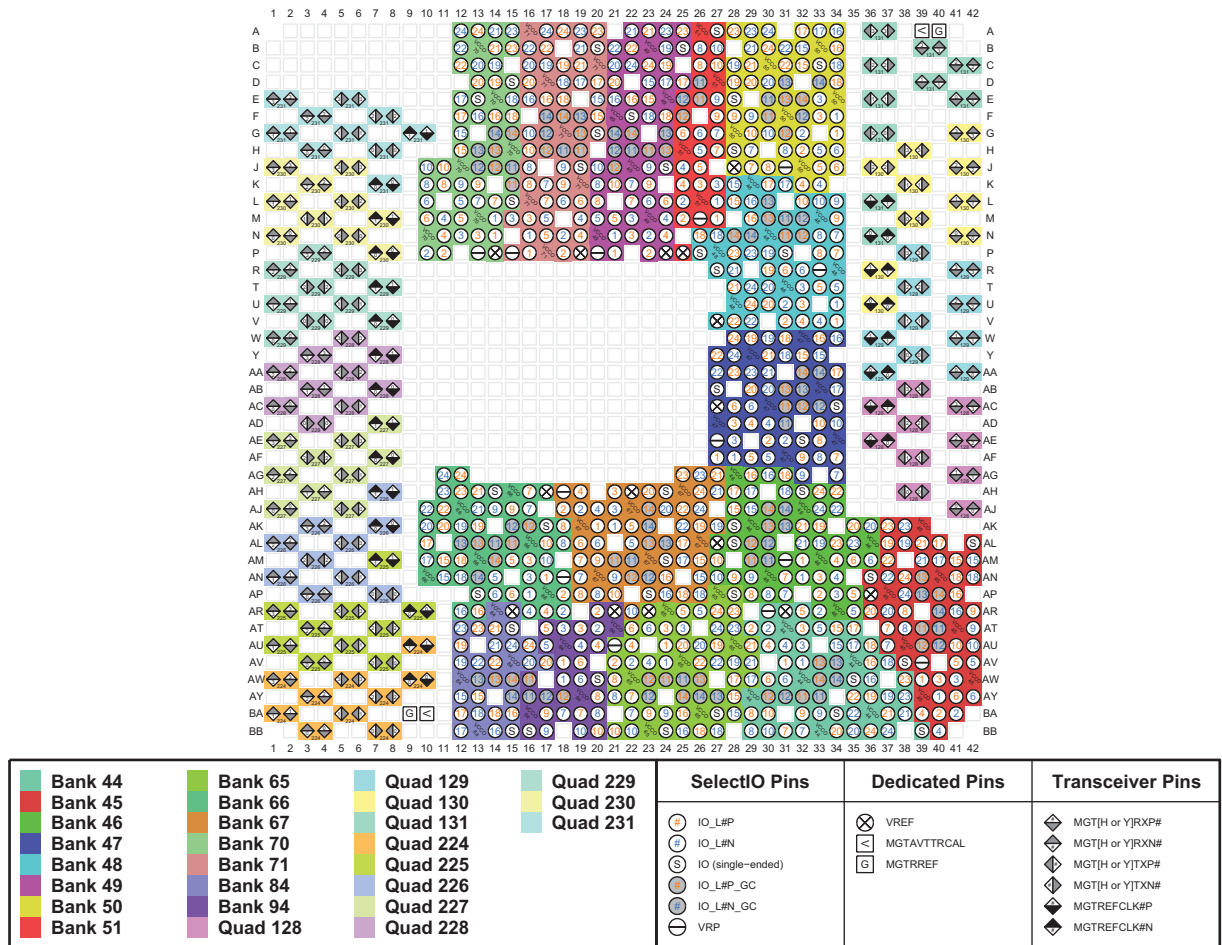

ug575_c3_25_100715

Figure 3-25: FFVB1760 Package—XCKU095 I/O Bank Diagram

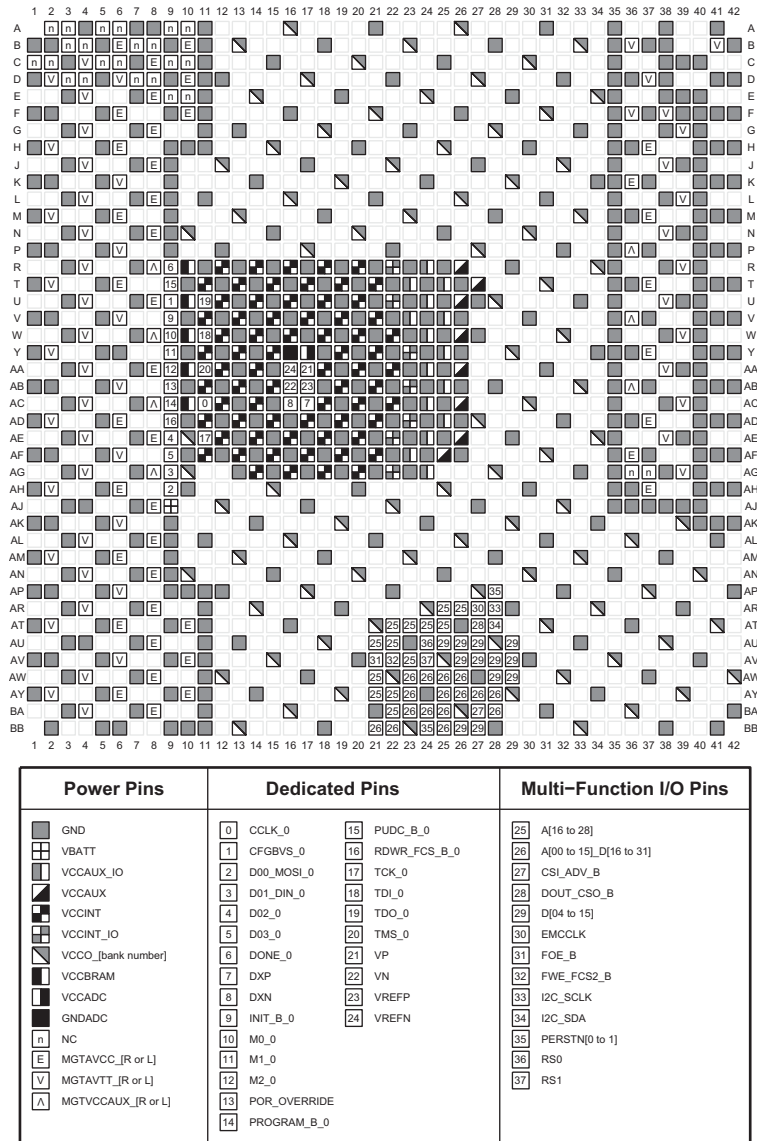

ug575_c3_26_100715

Figure 3-26: FFVB1760 Package—XCKU095 Configuration/Power Diagram

FLVB1760 (XCKU085)

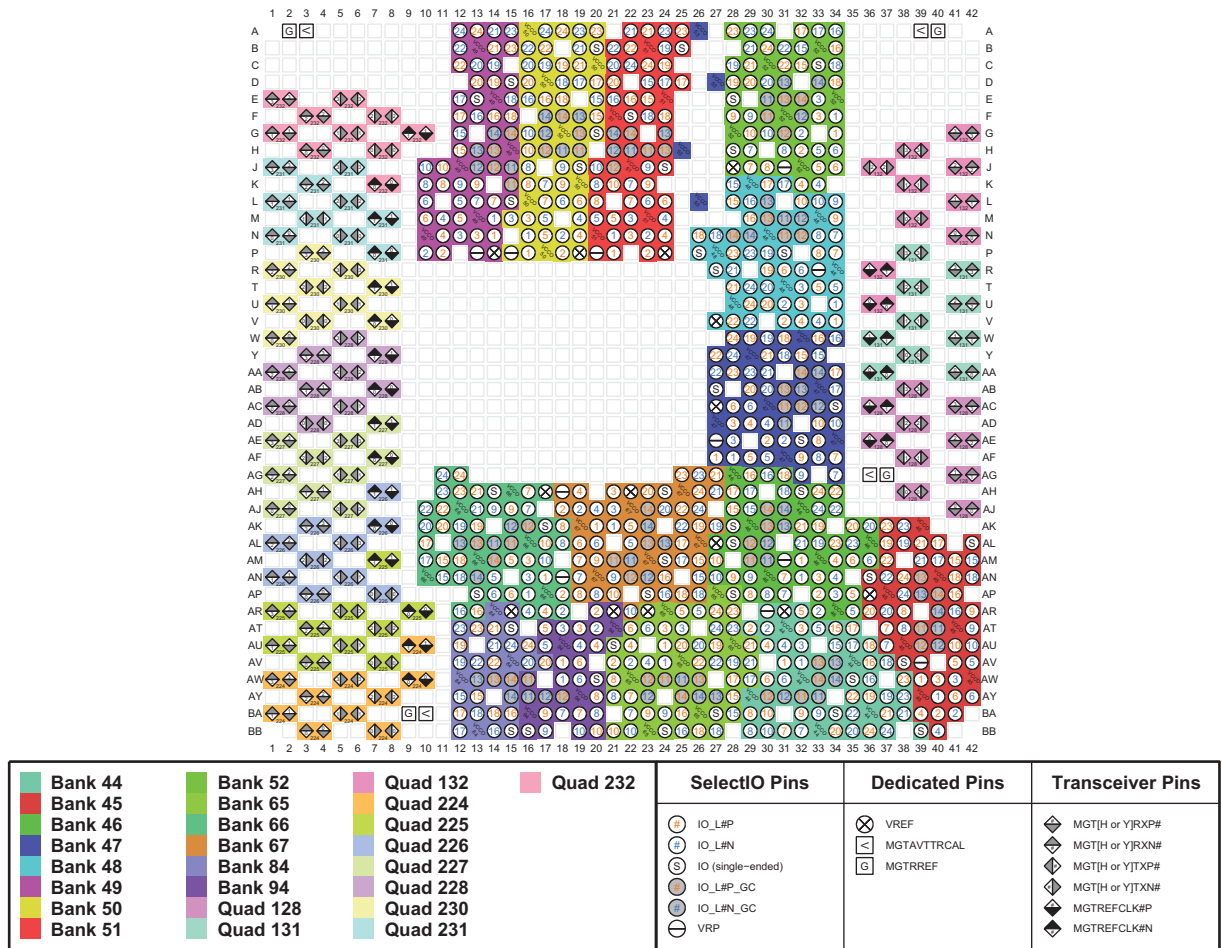

ug575_c3_27_100715

Figure 3-27: FLVB1760 Package—XCKU085 I/O Bank Diagram

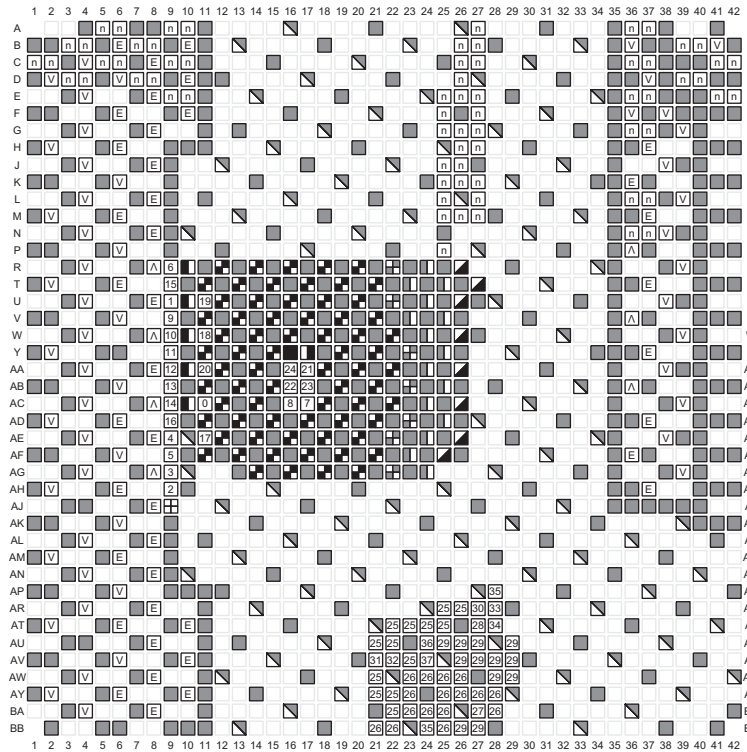

Power Pins	Dedicated Pins	Multi-Function I/O Pins
GND	0 CCLK_0	25 A[16 to 28]
VBATT	1 CFGBVS_0	26 A[00 to 15]_D[16 to 31]
VCCAUX_IO	2 D00_MOSI_0	27 CSI_ADV_B
VCCAUX	3 D01_DIN_0	28 DOUT_CSO_B
VCCINT	4 D02_0	29 D[04 to 15]
VCCINT_IO	5 D03_0	30 EMCCLK
VCCO_[bank number]	6 DONE_0	31 FOE_B
VCCBRAM	7 DXP	32 FWE_FCS2_B
VCCADC	8 DXN	33 I2C_SCLK
GNDADC	9 INIT_B_0	34 I2C_SDA
n NC	10 M0_0	35 PERSTN[0 to 1]
E MGTAVCC_[R or L]	11 M1_0	36 RS0
V MGTAVTT_[R or L]	12 M2_0	37 RS1
A MGTVCCAUX_[R or L]	13 POR_OVERRIDE	
	14 PROGRAM_B_0	
	15 PUDC_B_0	
	16 RDWR_FCS_B_0	
	17 TCK_0	
	18 TDI_0	
	19 TDO_0	
	20 TMS_0	
	21 VP	
	22 VN	
	23 VREFP	
	24 VREFN	

ug575_c3_28_100715

Figure 3-28: FLVB1760 Package—XCKU085 Configuration/Power Diagram

FLVB1760 (XCKU115)

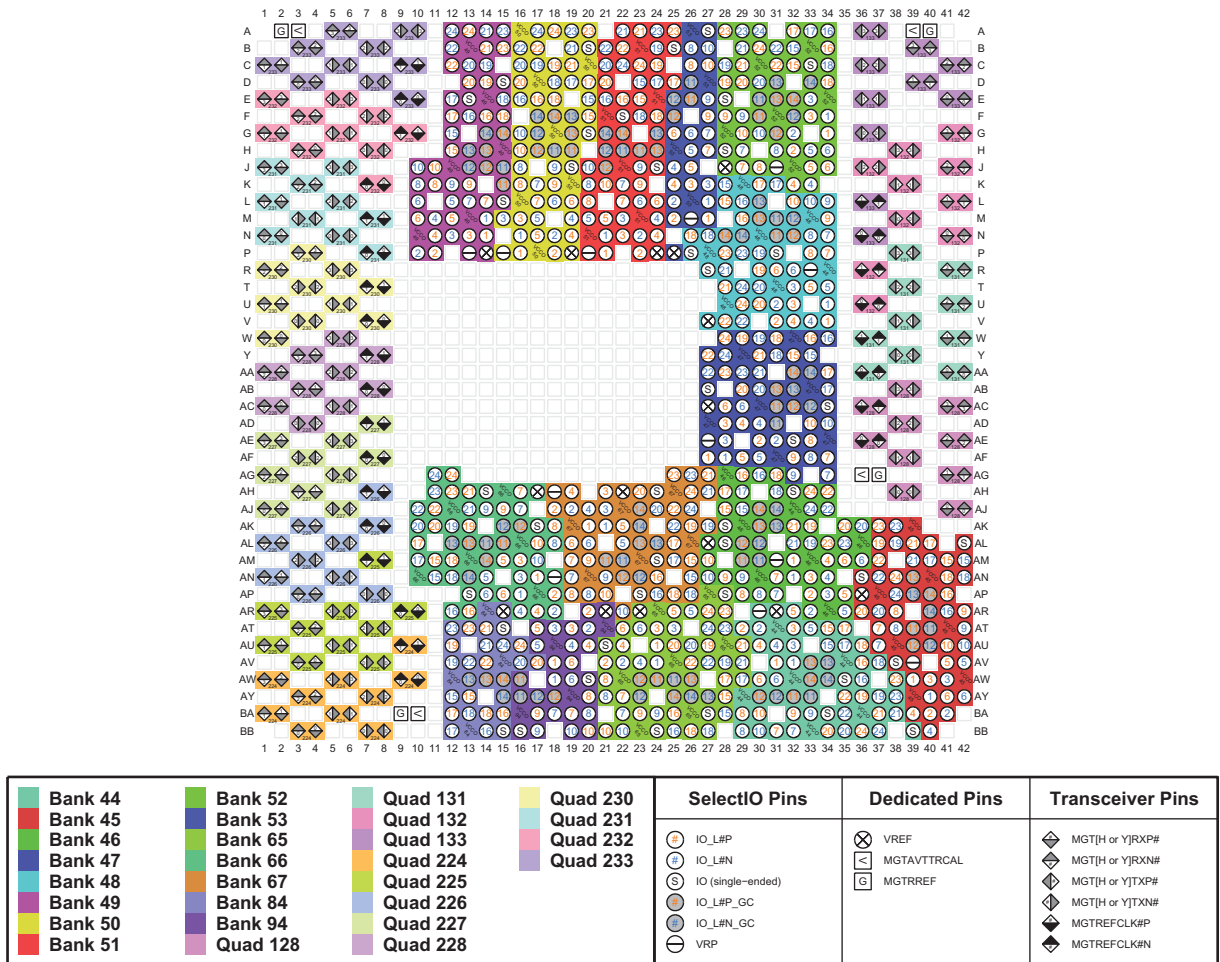

ug575_c3_29_100715

Figure 3-29: FLVB1760 Package—XCKU115 I/O Bank Diagram

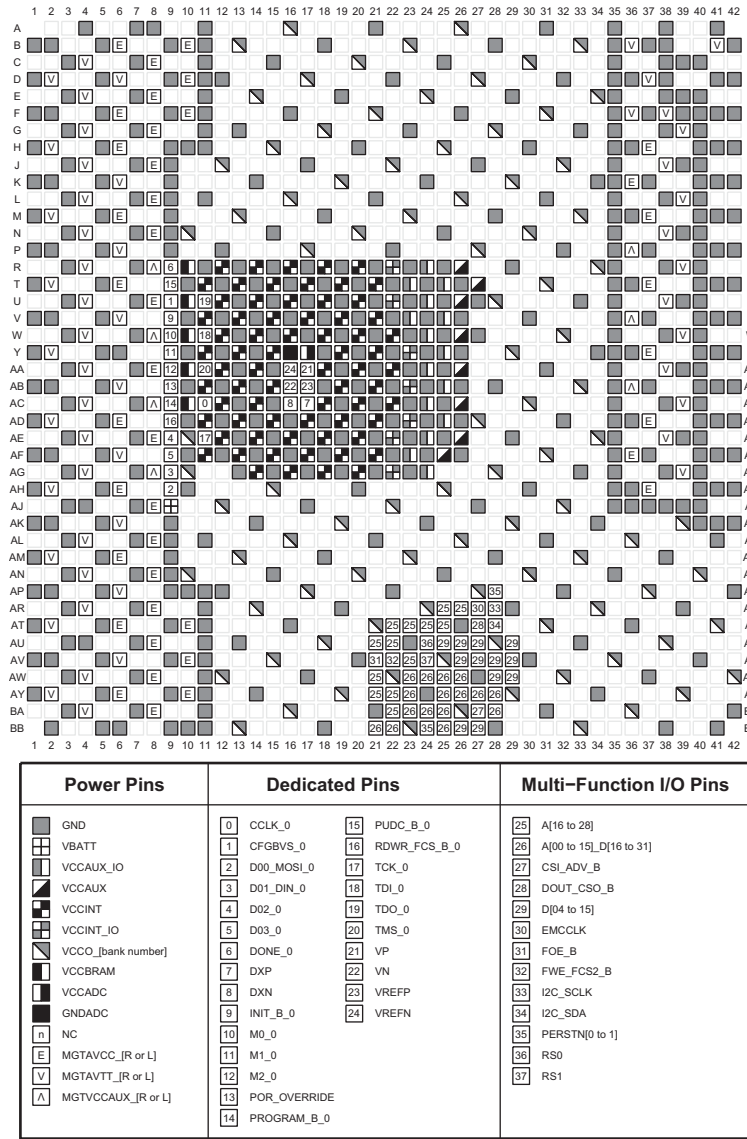

ug575_c3_30_100715

Figure 3-30: FLVB1760 Package—XCKU115 Configuration/Power Diagram

FLVD1924 (XCKU115)

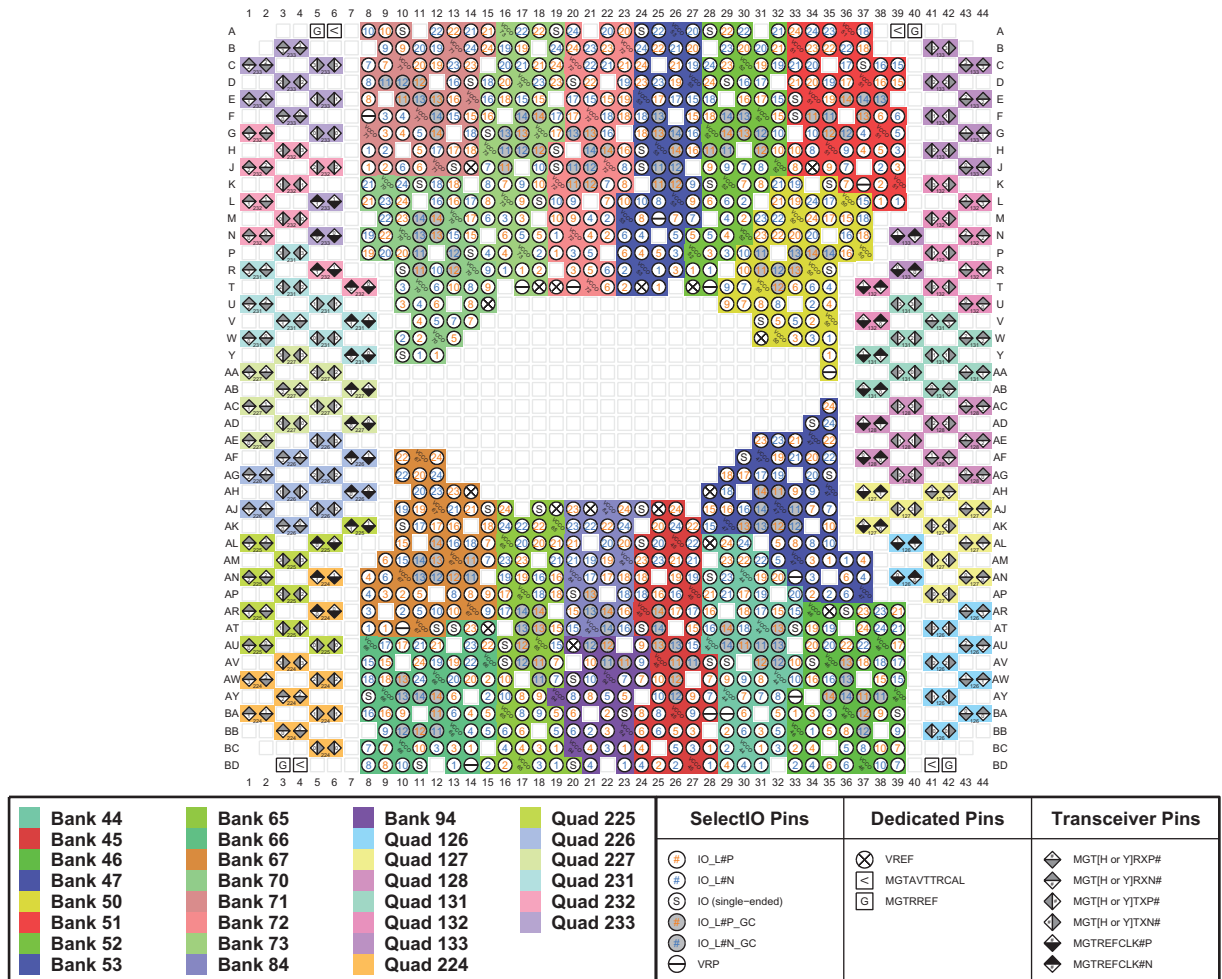

ug575_c3_31_100715

Figure 3-31: FLVD1924 Package—XCKU115 I/O Bank Diagram

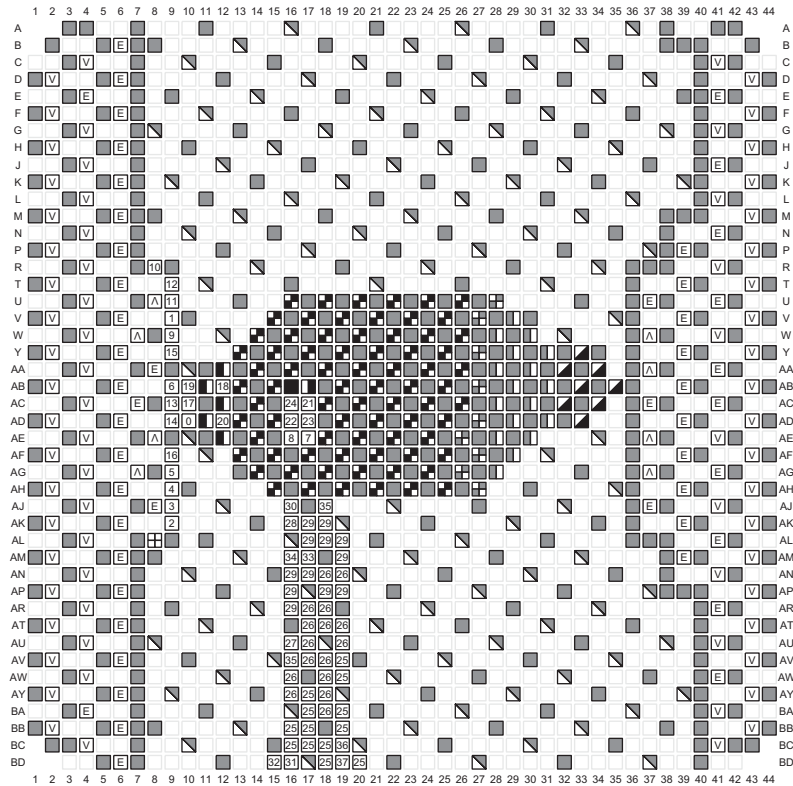

Power Pins	Dedicated Pins	Multi-Function I/O Pins
■ GND	0 CCLK_0	25 A[16 to 28]
⊕ VBATT	1 CFGBVS_0	26 A[00 to 15]_D[16 to 31]
▣ VCCAUX_IO	2 D00_MOSI_0	27 CSI_ADV_B
▤ VCCAUX	3 D01_DIN_0	28 DOUT_CSO_B
▥ VCCINT	4 D02_0	29 D[04 to 15]
⊕ VCCINT_IO	5 D03_0	30 EMCCLK
▤ VCCO_[bank number]	6 DONE_0	31 FOE_B
▥ VCCBRAM	7 DXP	32 FWE_FCS2_B
▥ VCCADC	8 DXN	33 I2C_SCLK
▥ GNDADC	9 INIT_B_0	34 I2C_SDA
□ NC	10 M0_0	35 PERSTN[0 to 1]
⊕ MGTAVCC_[R or L]	11 M1_0	36 RSO
⊕ MGTAVTT_[R or L]	12 M2_0	37 RS1
⊕ MGTVCCAUX_[R or L]	13 POR_OVERRIDE	
	14 PROGRAM_B_0	
	15 PUDC_B_0	
	16 RDWR_FCS_B_0	
	17 TCK_0	
	18 TDI_0	
	19 TDO_0	
	20 TMS_0	
	21 VP	
	22 VN	
	23 VREFP	
	24 VREFN	

ug575_c3_32_100715

Figure 3-32: FLVD1924 Package—XCKU115 Configuration/Power Diagram

FLVF1924 (XCKU085)

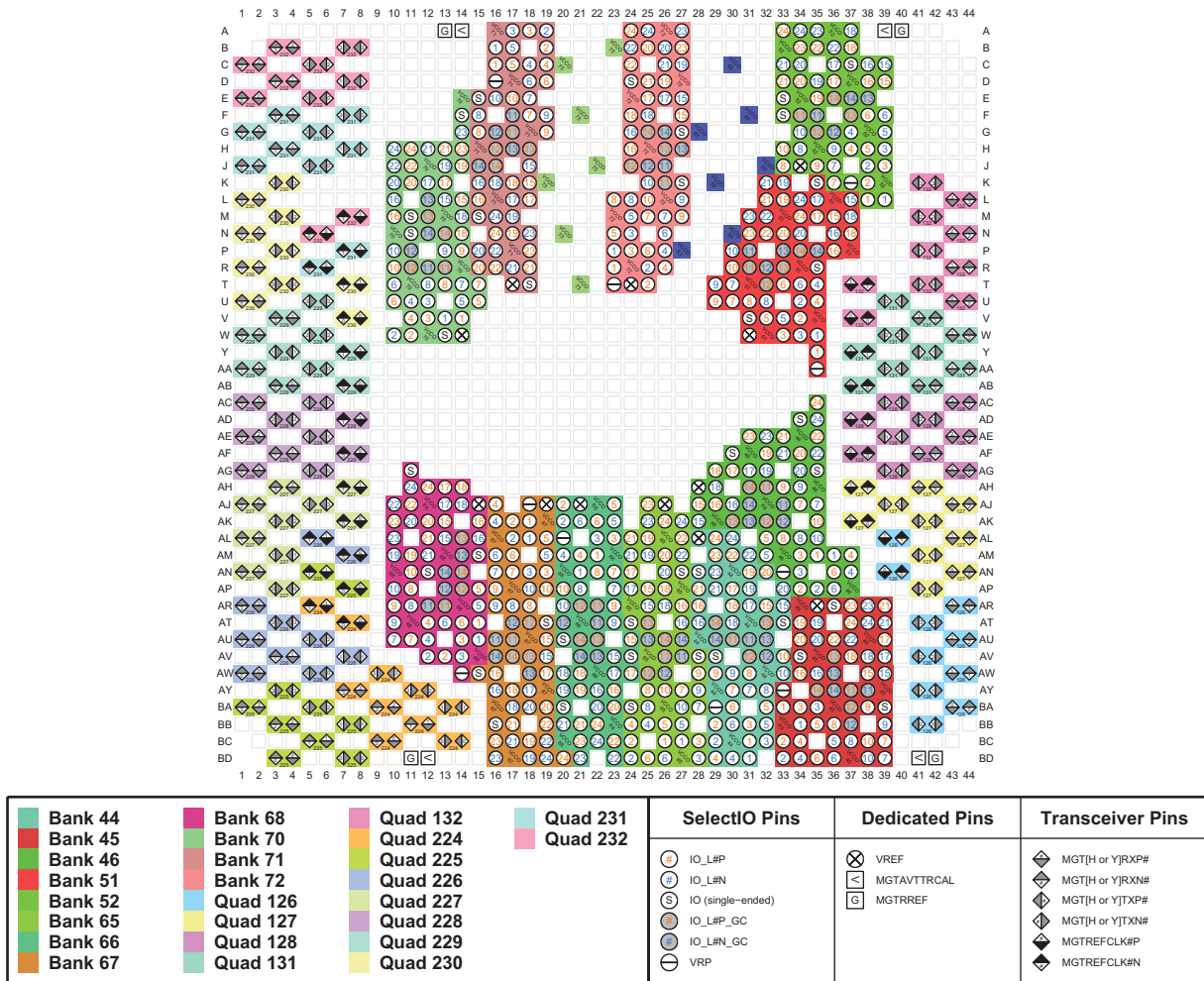

ug575_c3_33_100715

Figure 3-33: FLVF1924 Package—XCKU085 I/O Bank Diagram

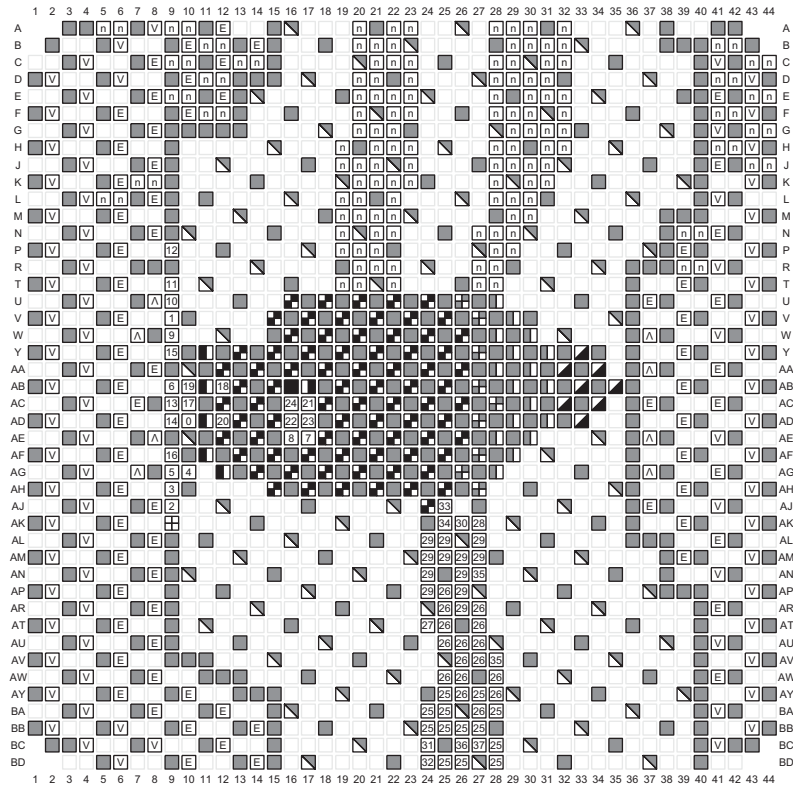

Power Pins	Dedicated Pins	Multi-Function I/O Pins
GND	0 CCLK_0	25 A[16 to 28]
VBATT	1 CFGBVS_0	26 A[00 to 15]_D[16 to 31]
VCCAUX_IO	2 D00_MOSI_0	27 CSI_ADV_B
VCCAUX	3 D01_DIN_0	28 DOUT_CSO_B
VCCINT	4 D02_0	29 D[04 to 15]
VCCINT_IO	5 D03_0	30 EMCLK
VCCO_[bank number]	6 DONE_0	31 FOE_B
VCCBRAM	7 DXP	32 FWE_FCS2_B
VCCADC	8 DXN	33 I2C_SCLK
GNDADC	9 INIT_B_0	34 I2C_SDA
NC	10 M0_0	35 PERSTN[0 to 1]
MGTAVCC_[R or L]	11 M1_0	36 RSO
MGTAVTT_[R or L]	12 M2_0	37 RS1
MGTVCCAUX_[R or L]	13 POR_OVERRIDE	
	14 PROGRAM_B_0	
	15 PUDC_B_0	
	16 RDWR_FCS_B_0	
	17 TCK_0	
	18 TDI_0	
	19 TDO_0	
	20 TMS_0	
	21 VP	
	22 VN	
	23 VREFP	
	24 VREFN	

ug575_e3_34_100715

Figure 3-34: FLVF1924 Package—XCKU085 Configuration/Power Diagram

FLVF1924 (XCKU115) and RLF1924 (XQKU115)

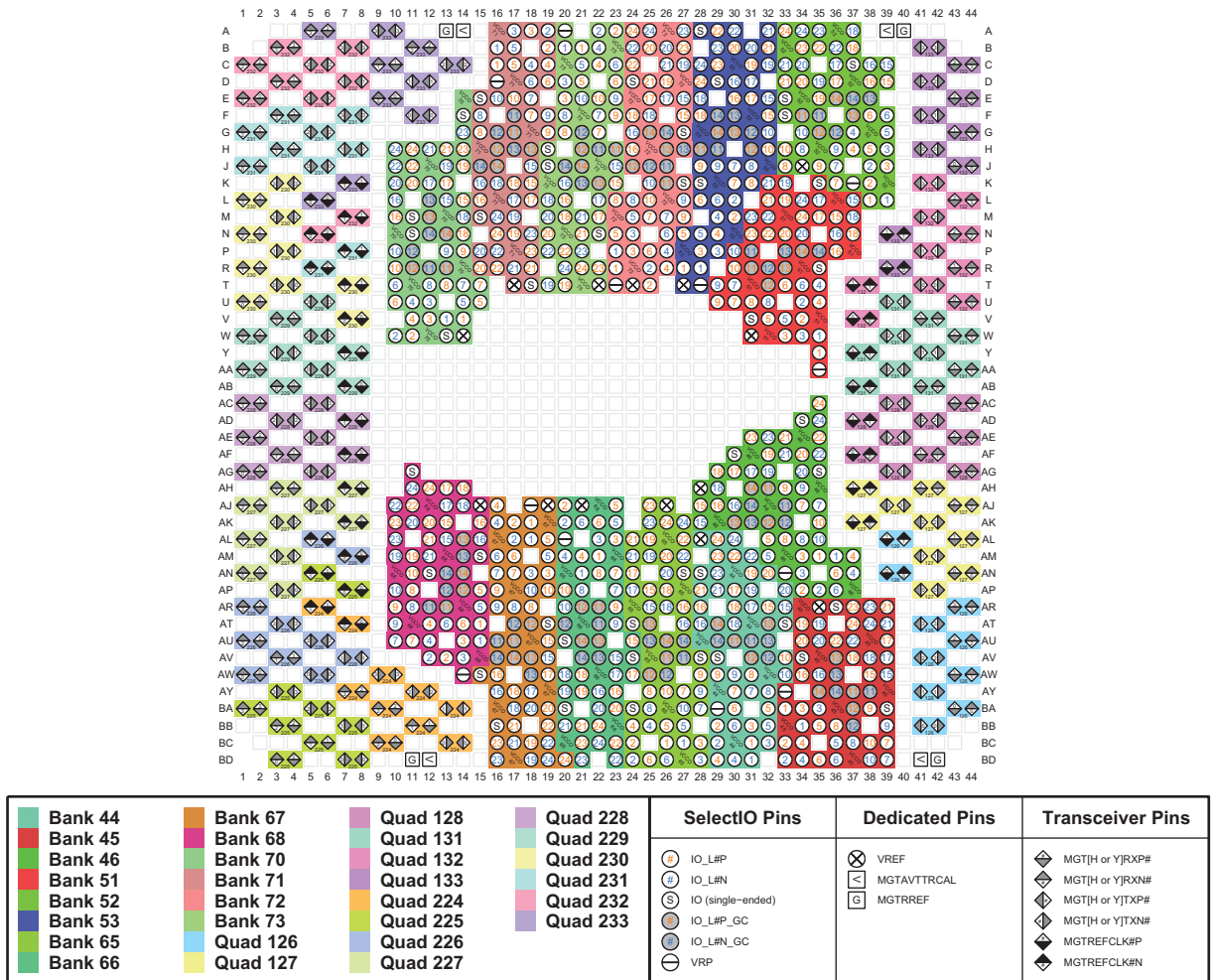

ug575_c3_35_100715

Figure 3-35: FLVF1924 Package—XCKU115 and RLF1924 Package—XQKU115 I/O Bank Diagram

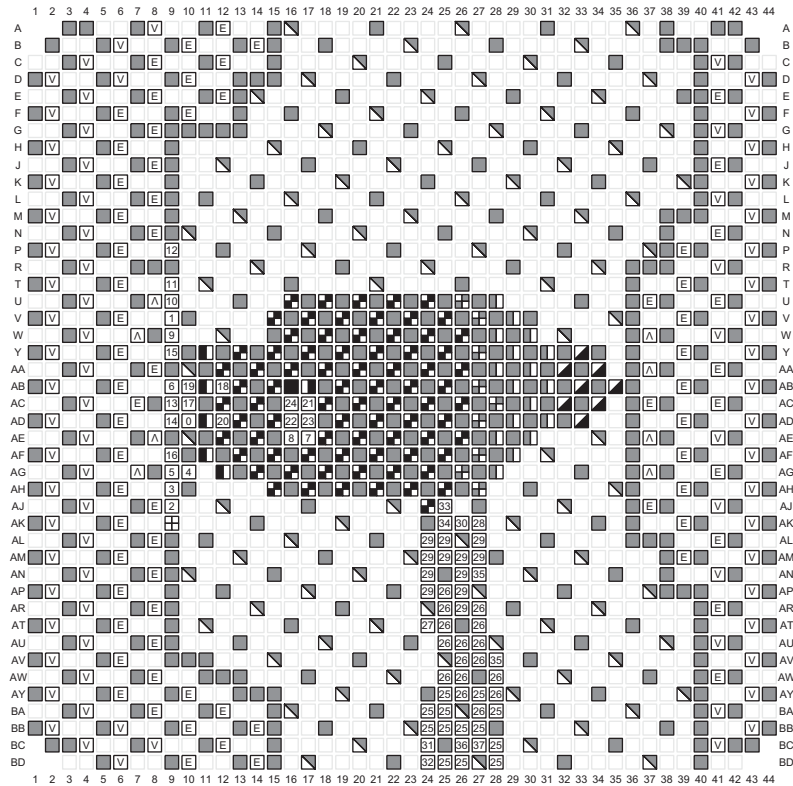

Power Pins	Dedicated Pins	Multi-Function I/O Pins
GND	0 CCLK_0	25 A[16 to 28]
VBATT	1 CFGBVS_0	26 A[00 to 15]_D[16 to 31]
VCCAUX_IO	2 D00_MOSL_0	27 CSI_ADV_B
VCCAUX	3 D01_DIN_0	28 DOUT_CSO_B
VCCINT	4 D02_0	29 D[4 to 15]
VCCINT_IO	5 D03_0	30 EMCCLK
VCCO_[bank number]	6 DONE_0	31 F0E_B
VCCBRAM	7 DXP	32 FWE_FCS2_B
VCCADC	8 DXN	33 I2C_SCLK
GNDADC	9 INIT_B_0	34 I2C_SDA
NC	10 M0_0	35 PERSTN[0 to 1]
MGTAVCC_[R or L]	11 M1_0	36 RS0
MGTAVTT_[R or L]	12 M2_0	37 RS1
MGTVCCAUX_[R or L]	13 POR_OVERRIDE	
	14 PROGRAM_B_0	
	15 PUDC_B_0	
	16 RDWR_FCS_B_0	
	17 TCK_0	
	18 TDI_0	
	19 TDO_0	
	20 TMS_0	
	21 VP	
	22 VN	
	23 VREFP	
	24 VREFN	

ug575_c3_36_100715

Figure 3-36: FLVF1924 Package—XCKU115 and RLF1924 Package—XQKU115 Configuration/Power Diagram

FLVA2104 (XCKU115)

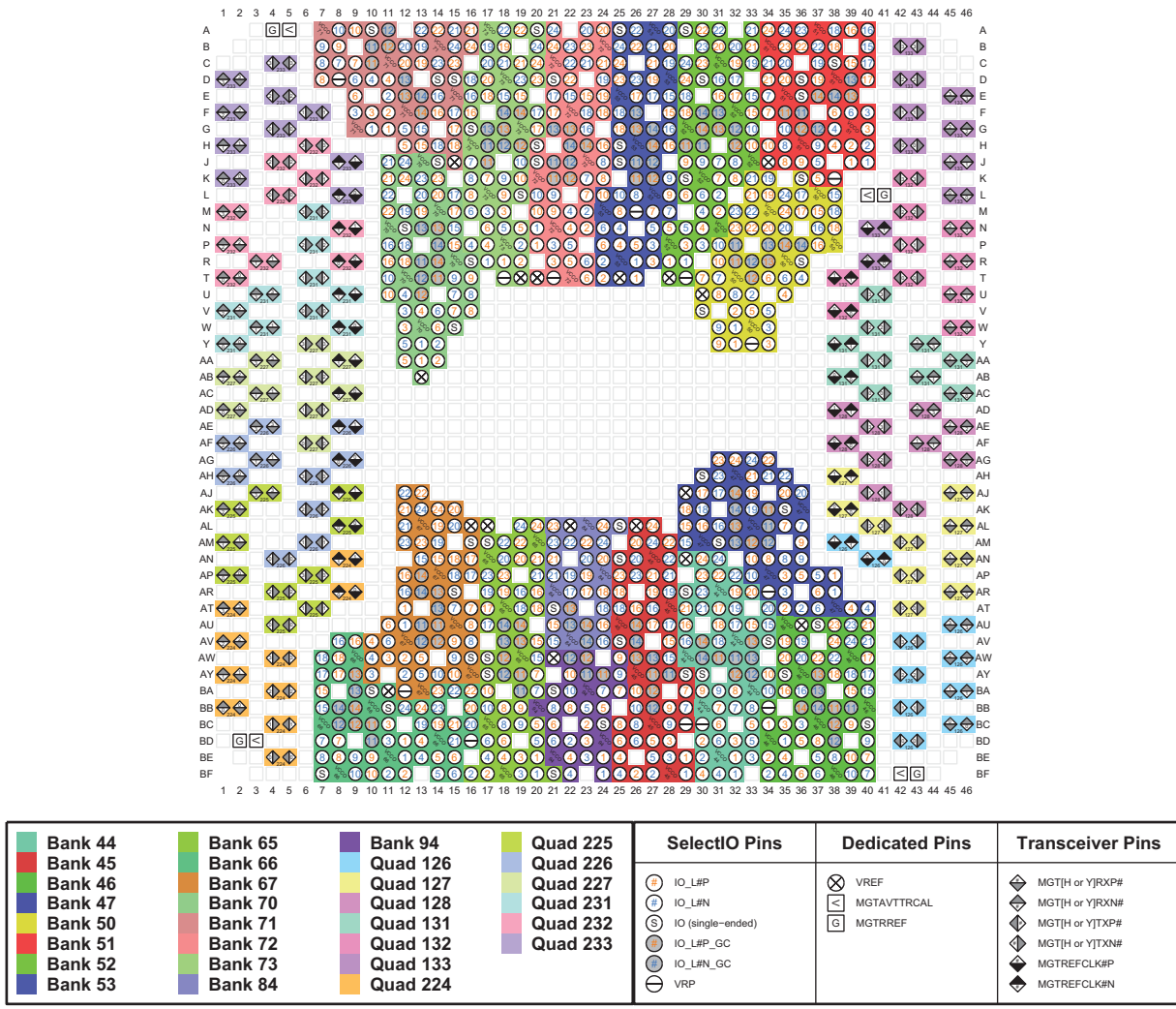
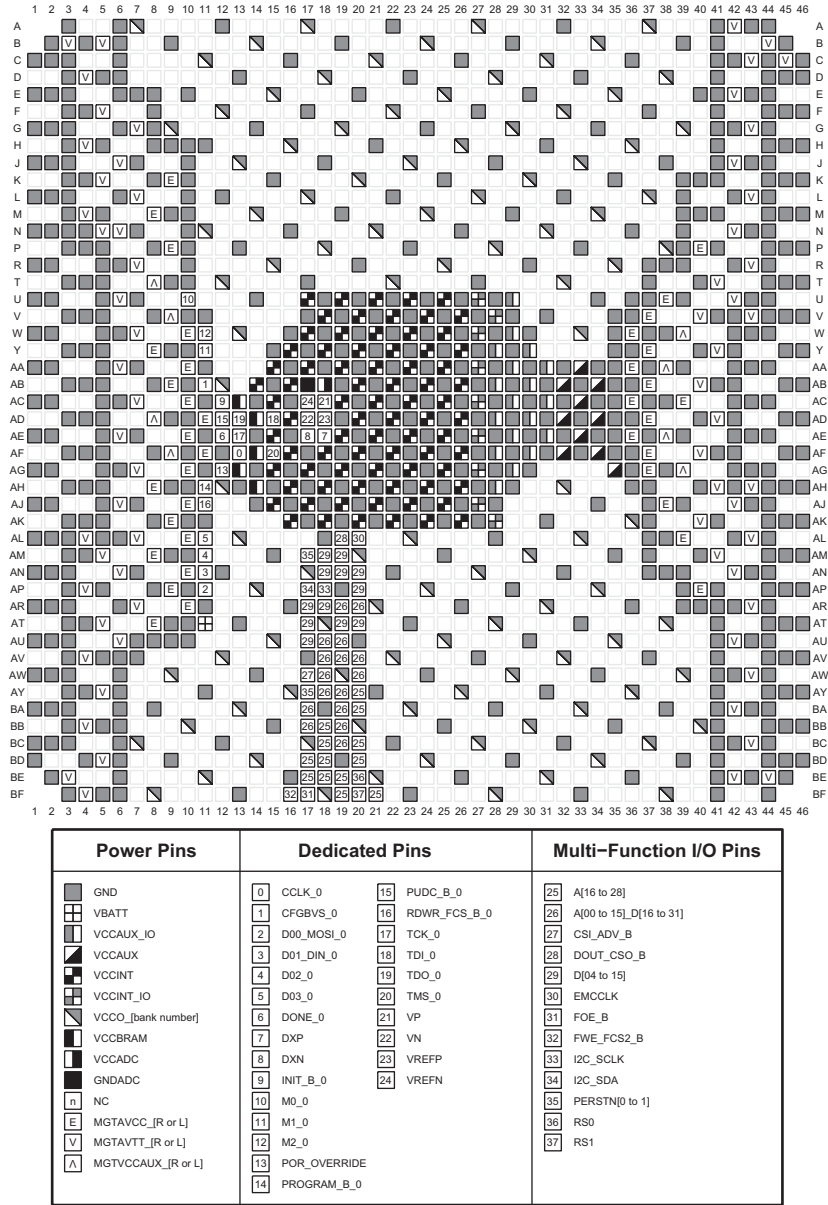

Figure 3-37: FLVA2104 Package—XCKU115 I/O Bank Diagram



ug575_c3_38_100715

Figure 3-38: FLVA2104 Package—XCKU115 Configuration/Power Diagram

FFVB2104 (XCKU095)

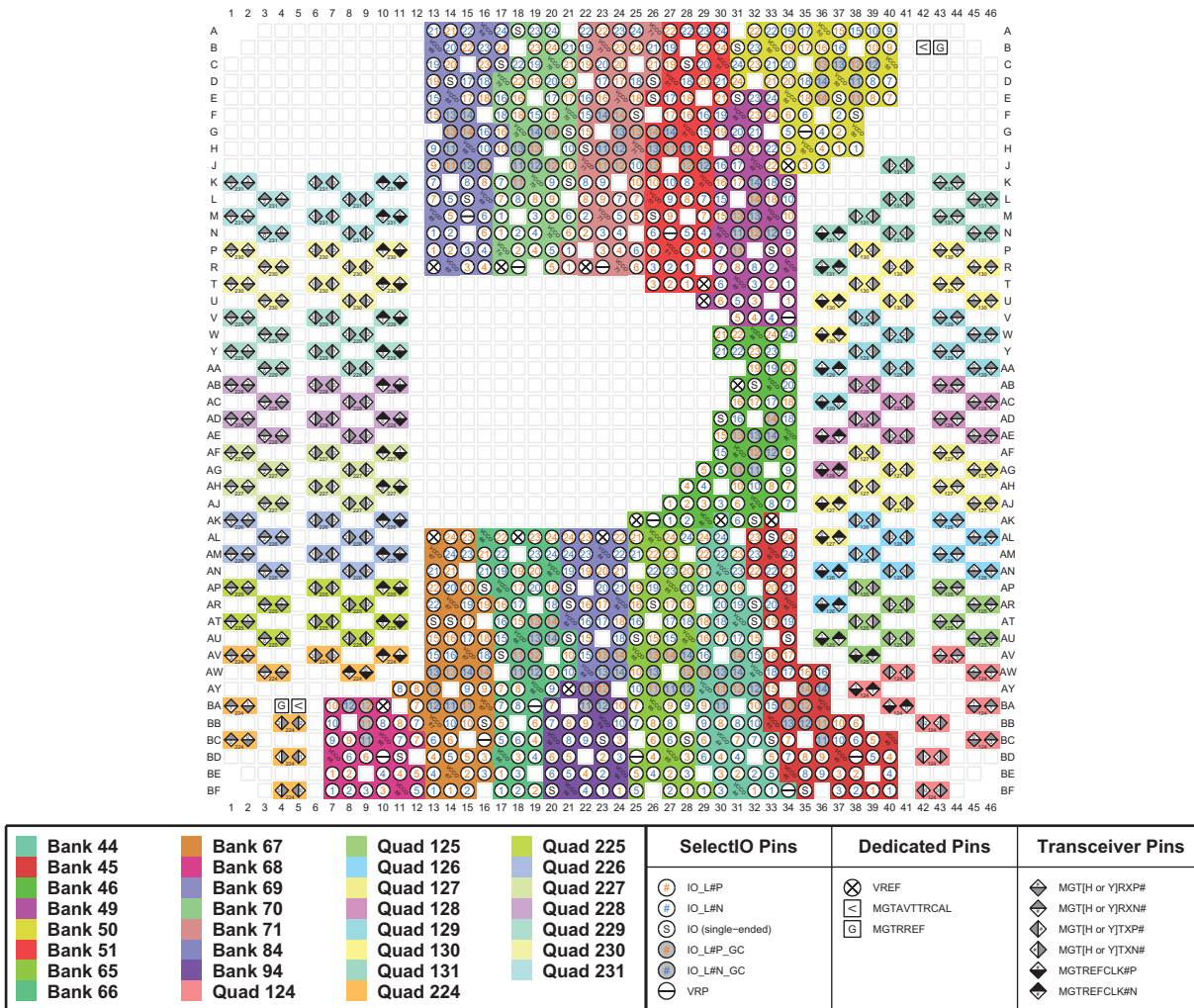

ug575_c3_39_100715

Figure 3-39: FFVB2104 Package—XCKU095 I/O Bank Diagram

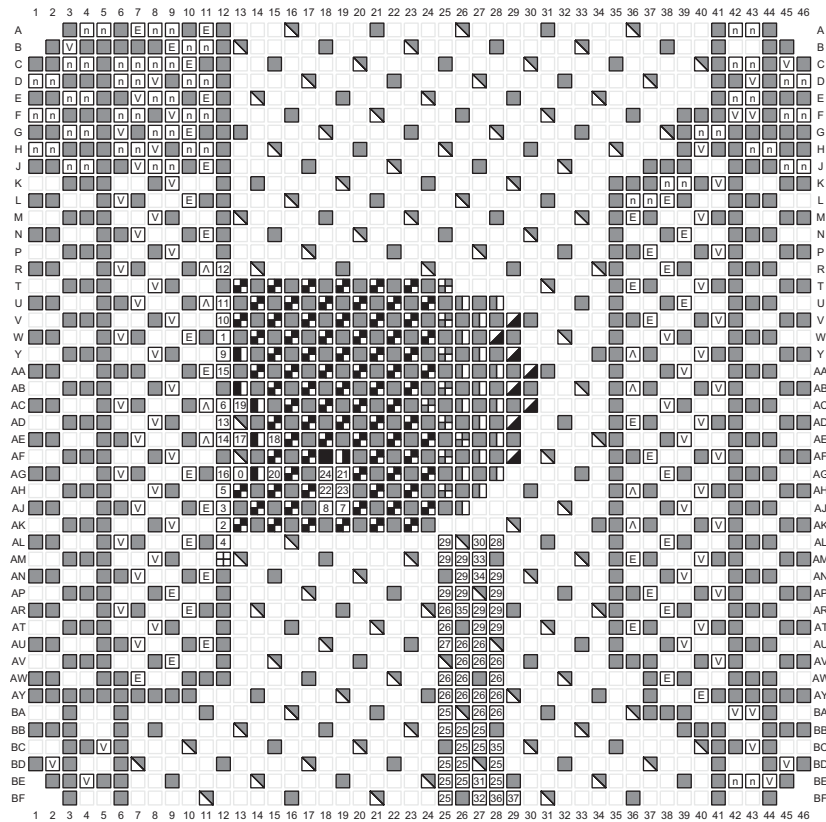

Power Pins	Dedicated Pins	Multi-Function I/O Pins
GND	0 CCLK_0	25 A[16 to 28]
VBATT	1 CFGBVS_0	26 A[0 to 15]_D[16 to 31]
VCCAUX_IO	2 D00_MOSI_0	27 CSI_ADV_B
VCCAUX	3 D01_DIN_0	28 DOUT_CSO_B
VCCINT	4 D02_0	29 D[4 to 15]
VCCINT_IO	5 D03_0	30 EMCCLK
VCCO_[bank number]	6 DONE_0	31 FOE_B
VCCBRAM	7 DXP	32 FWE_FCS2_B
VCCADC	8 DXN	33 I2C_SCLK
GNDADC	9 INIT_B_0	34 I2C_SDA
n NC	10 M0_0	35 PERSTN[0 to 1]
E MGTAVCC_[R or L]	11 M1_0	36 RS0
V MGTAVTT_[R or L]	12 M2_0	37 RS1
A MGTVCCAUX_[R or L]	13 POR_OVERRIDE	
	14 PROGRAM_B_0	
	15 PUDC_B_0	
	16 RDWR_FCS_B_0	
	17 TCK_0	
	18 TDI_0	
	19 TDO_0	
	20 TMS_0	
	21 VP	
	22 VN	
	23 VREFP	
	24 VREFN	

ug575_c3_40_100715

Figure 3-40: FFVB2104 Package—XCKU095 Configuration/Power Diagram

FLVB2104 (XCKU115)

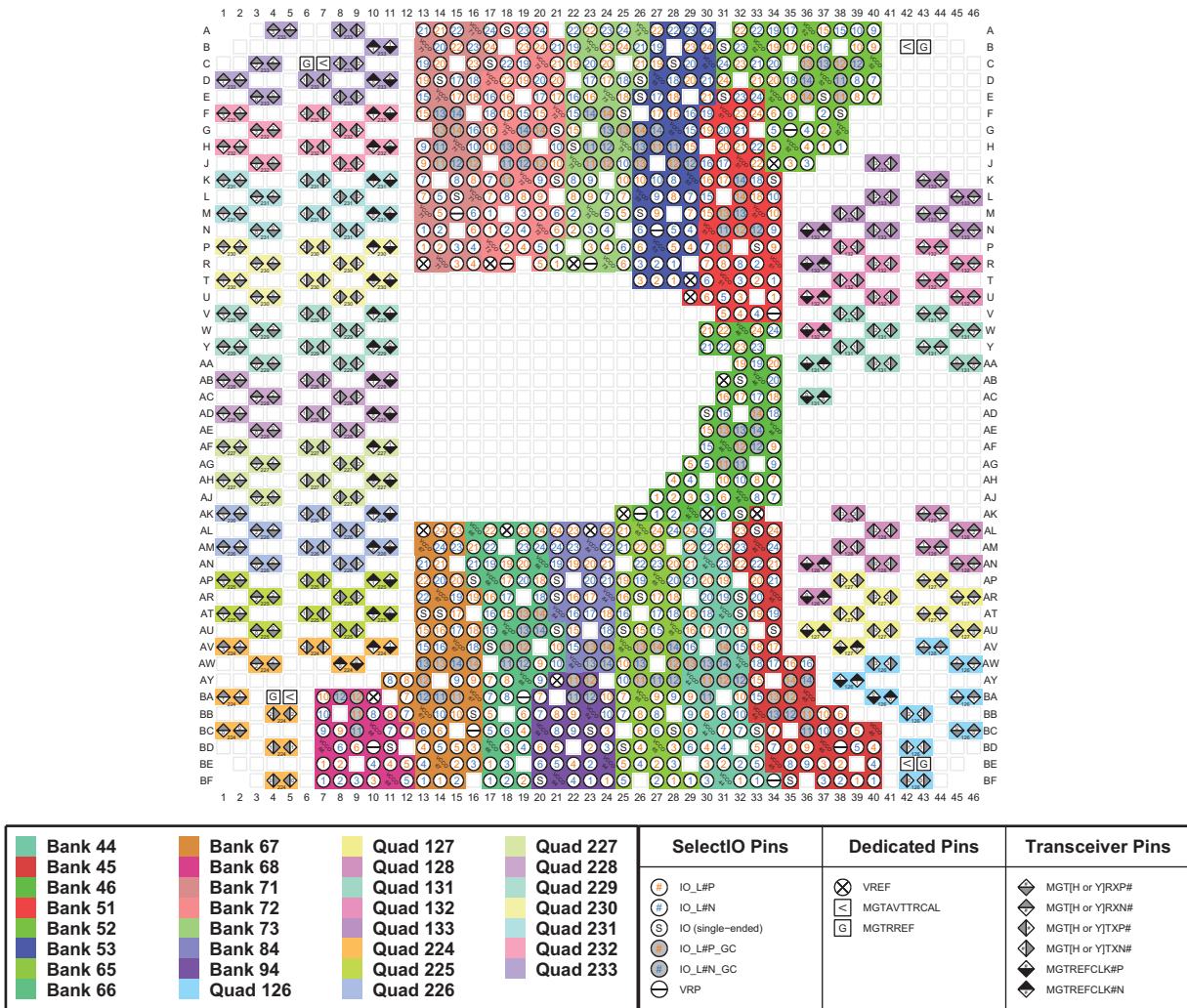

ug575_c3_41_100715

Figure 3-41: FLVB2104 Package—XCKU115 I/O Bank Diagram

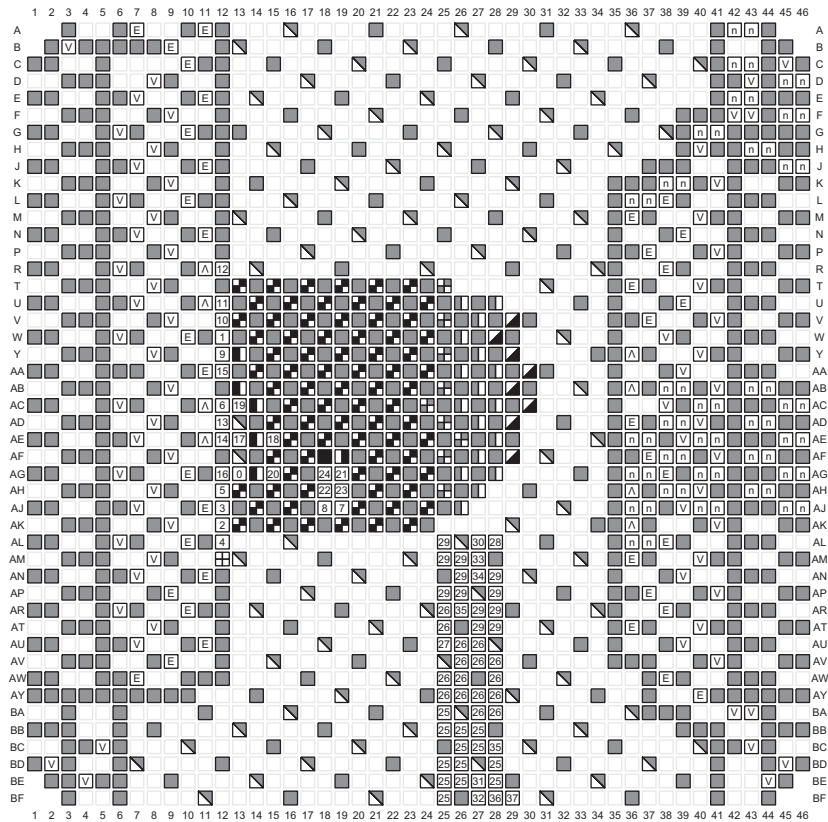

Power Pins	Dedicated Pins	Multi-Function I/O Pins
<ul style="list-style-type: none"> GND VBATT VCCAUX_IO VCCAUX VCCINT VCCINT_IO VCCO_[bank number] VCCBRAM VCCADC GNDADC NC MGTAVCC_[R or L] MGTAVTT_[R or L] MGTVCCAUX_[R or L] 	<ul style="list-style-type: none"> CCLK_0 CFGBVS_0 D00_MOSI_0 D01_DIN_0 D02_0 D03_0 DONE_0 DXP DXN INIT_B_0 M0_0 M1_0 M2_0 POR_OVERRIDE PROGRAM_B_0 PUDC_B_0 RDWR_FCS_B_0 TCK_0 TDI_0 TDO_0 TMS_0 VP VN VREFP VREFN 	<ul style="list-style-type: none"> A[16 to 28] A[00 to 15]_D[16 to 31] CSI_ADV_B DOUT_CSO_B D[04 to 15] EMCCLK FOE_B FWE_FCS2_B I2C_SCLK I2C_SDA PERSTN[0 to 1] RSO RS1

ug575_c3_42_100715

Figure 3-42: FLVB2104 Package—XCKU115 Configuration/Power Diagram

FFVC1517 (XCVU065)

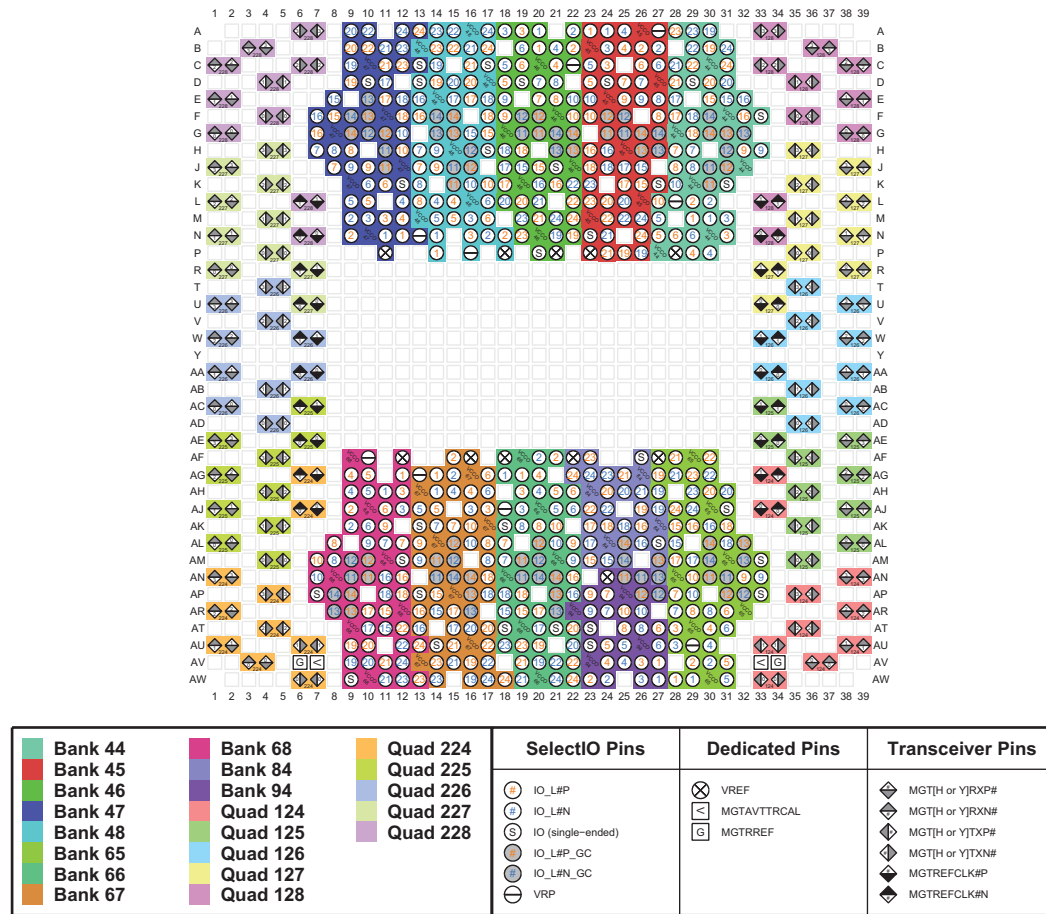

ug575_c3_43_100815

Figure 3-43: FFVC1517 Package—XCVU065 I/O Bank Diagram

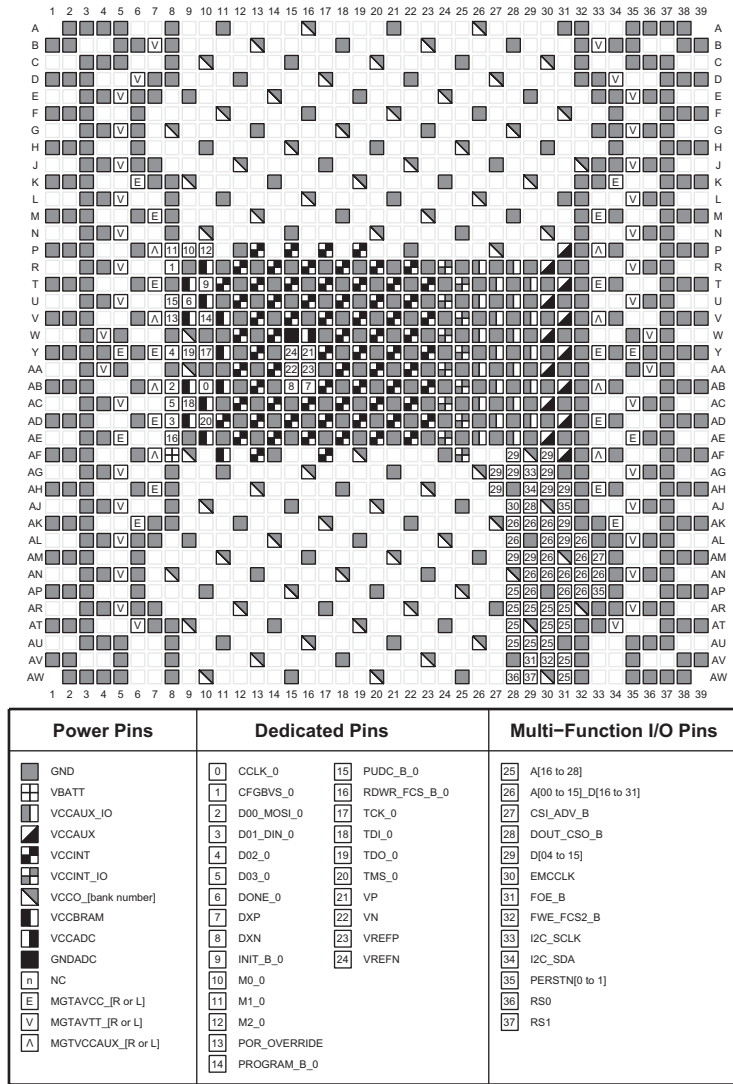

ug575_c3_44_100815

Figure 3-44: FFVC1517 Package—XCVU065 Configuration/Power Diagram

FFVC1517 (XCVU080 and XCVU095)

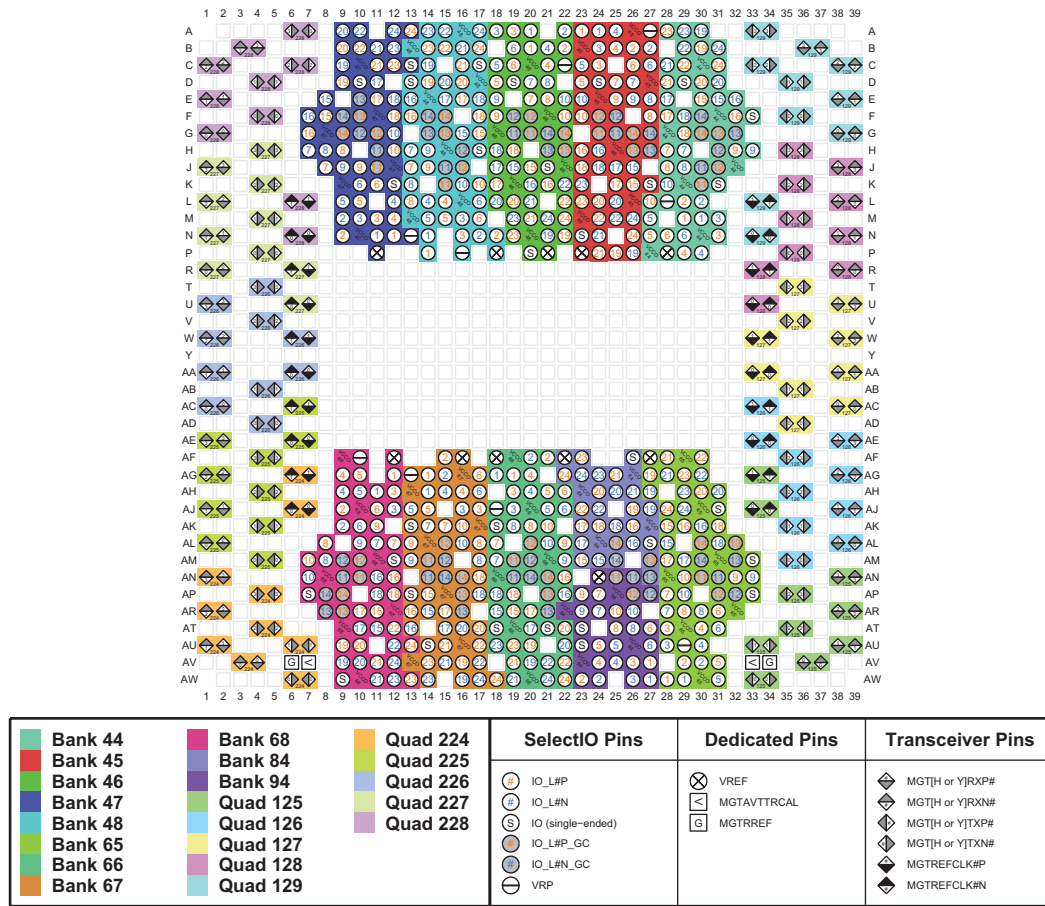

ug575_c3_45_100815

Figure 3-45: FFVC1517 Package—I/O Bank Diagram

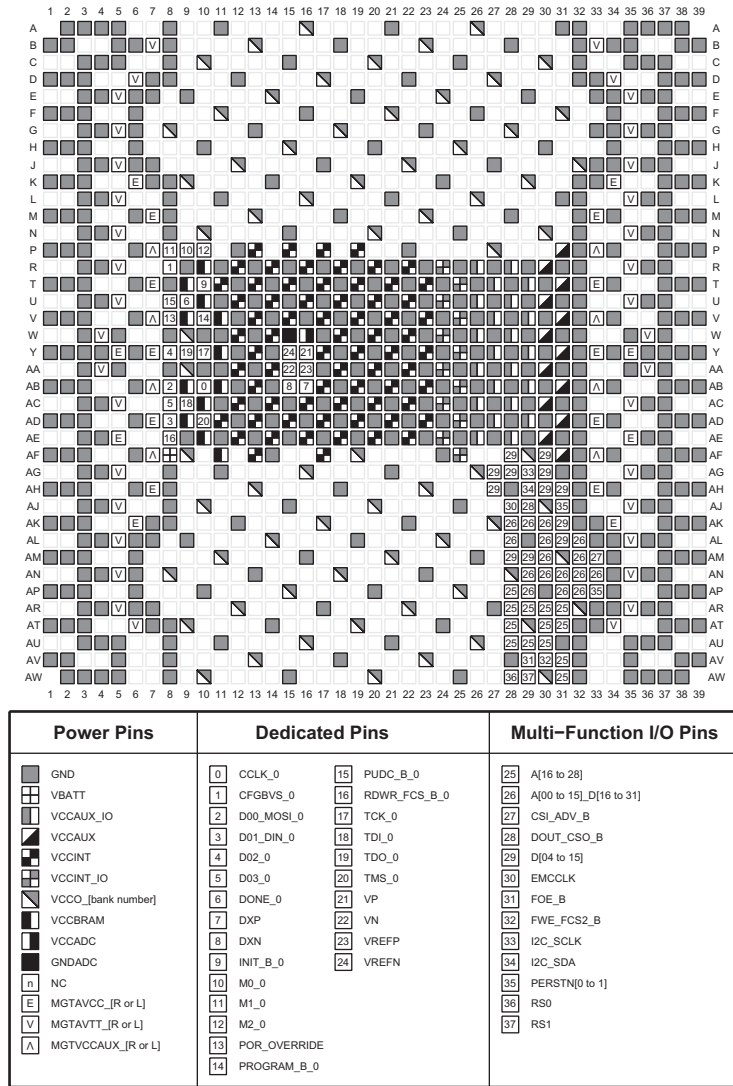

ug575_c3_46_100815

Figure 3-46: FFVC1517 Package—XCVU080 and XCVU095 Configuration/Power Diagram

FFVD1517 (XCVU080 and XCVU095)

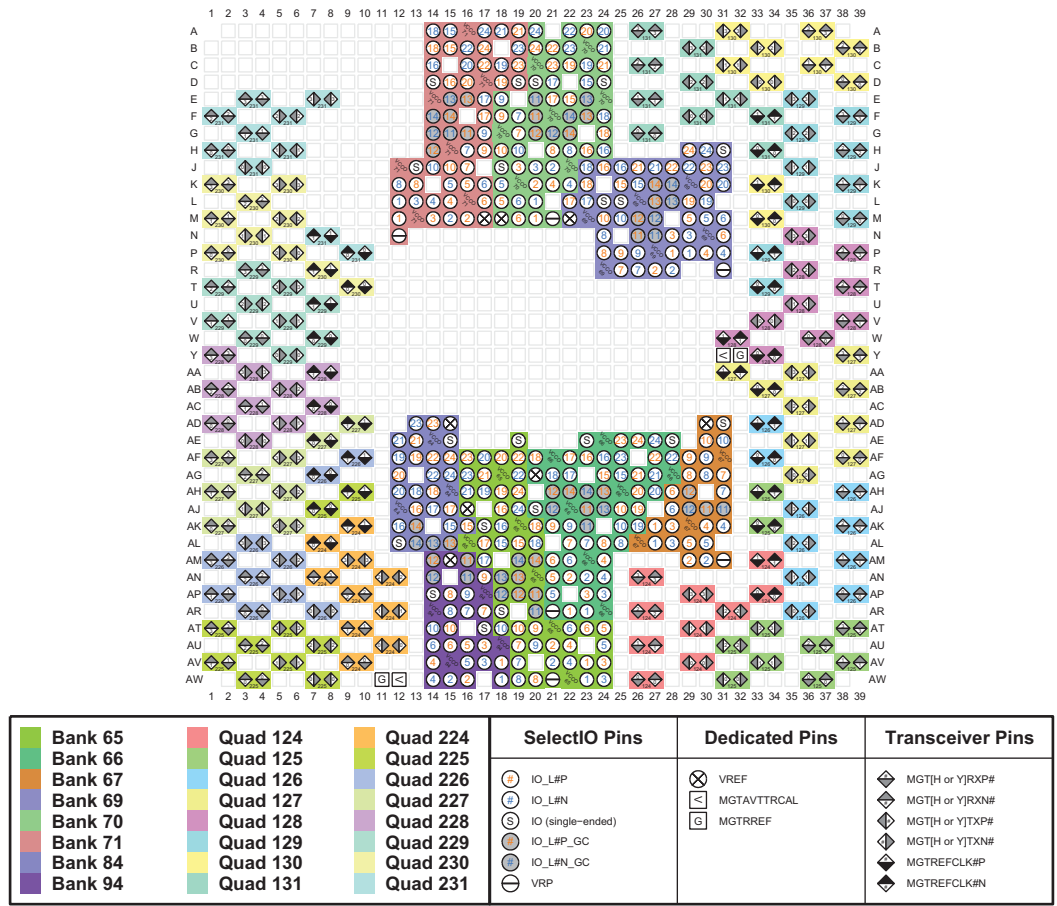

ug575_c3_47_100815

Figure 3-47: FFVD1517 Package—XCVU080 and XCVU095 I/O Bank Diagram

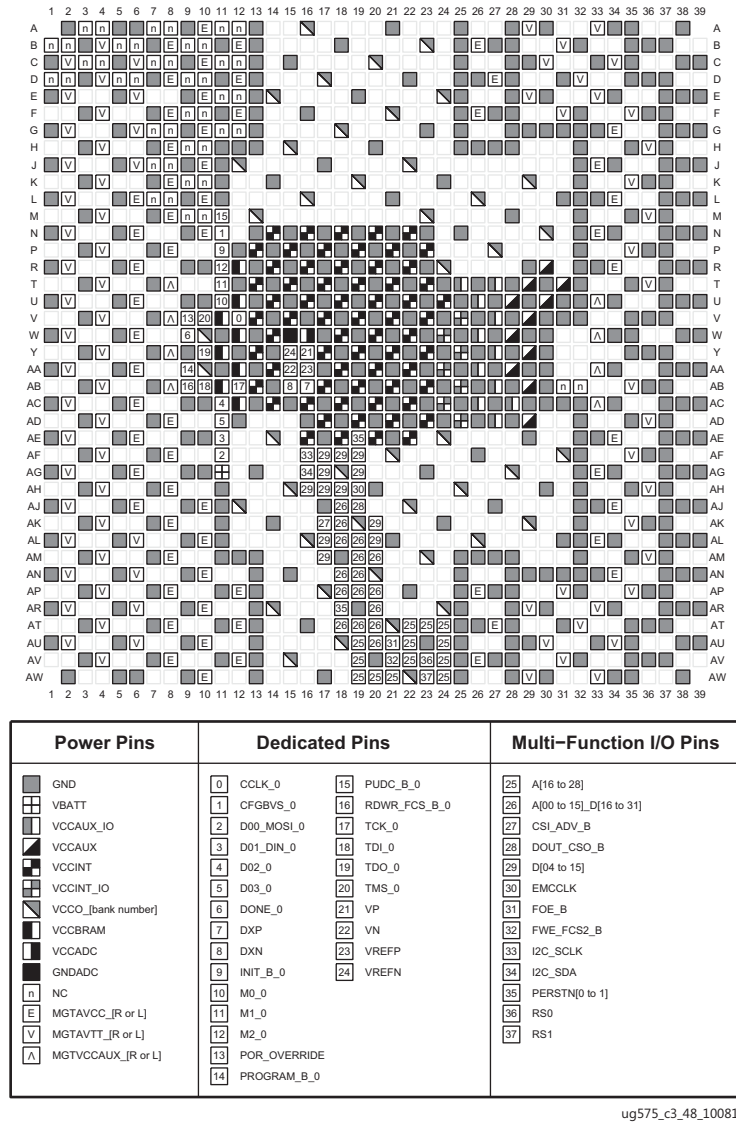
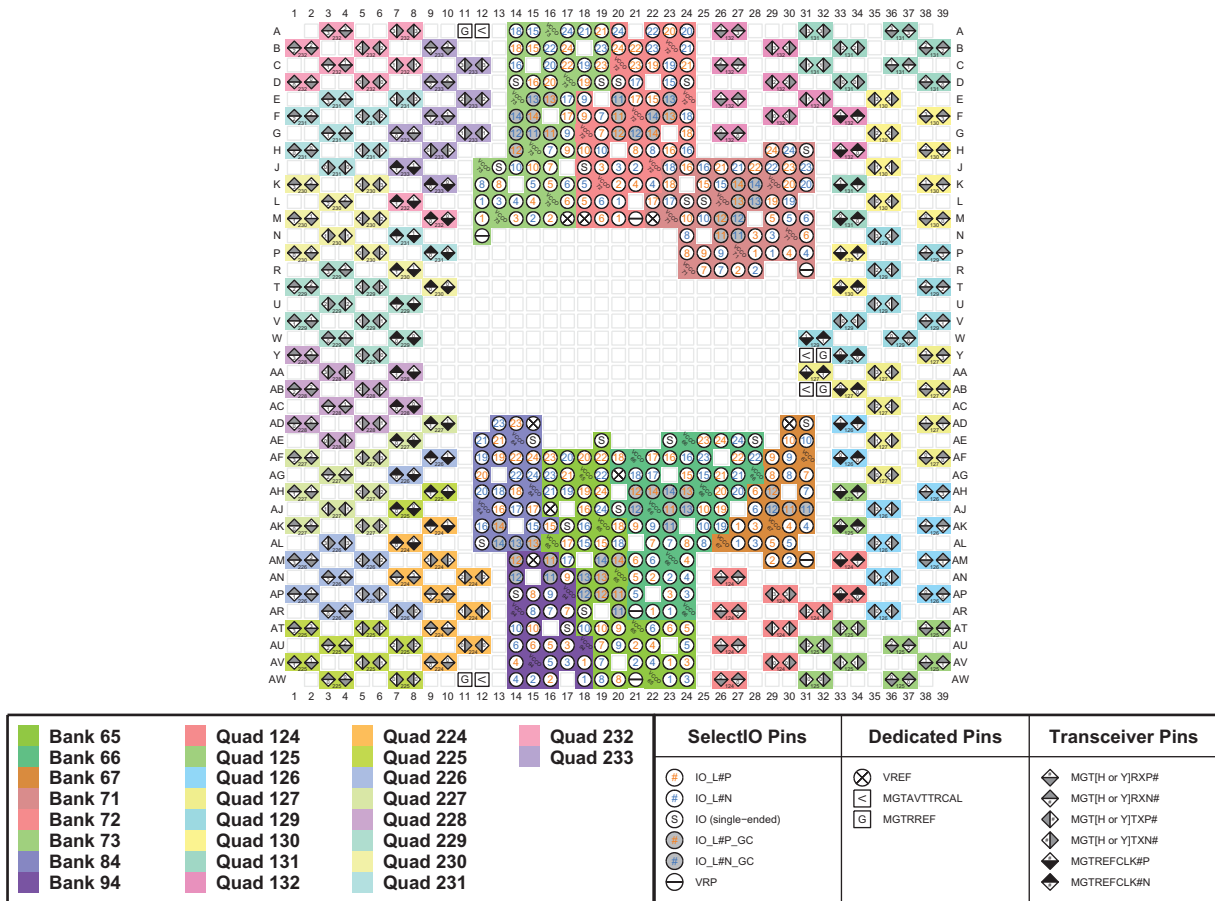

Figure 3-48: FFVD1517 Package—XCVU080 and XCVU095 Configuration/Power Diagram

FLVD1517 (XCVU125)



ug575_c3_49_100815

Figure 3-49: FLVD1517 Package—XCVU125 I/O Bank Diagram

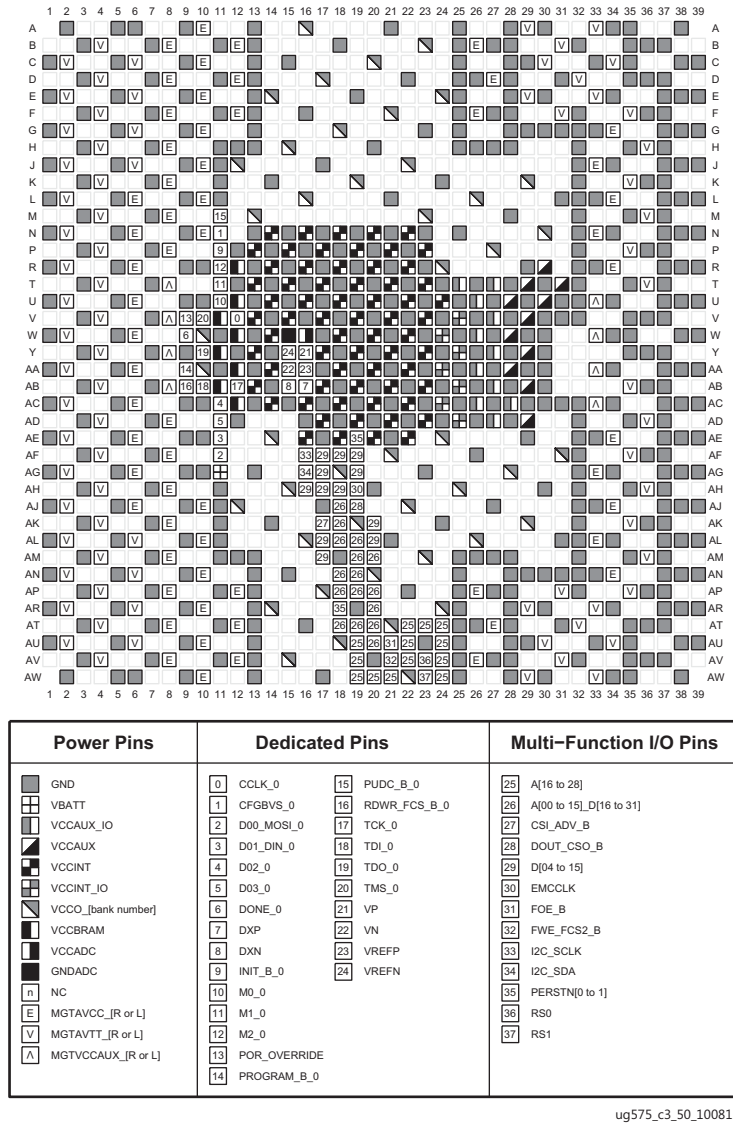
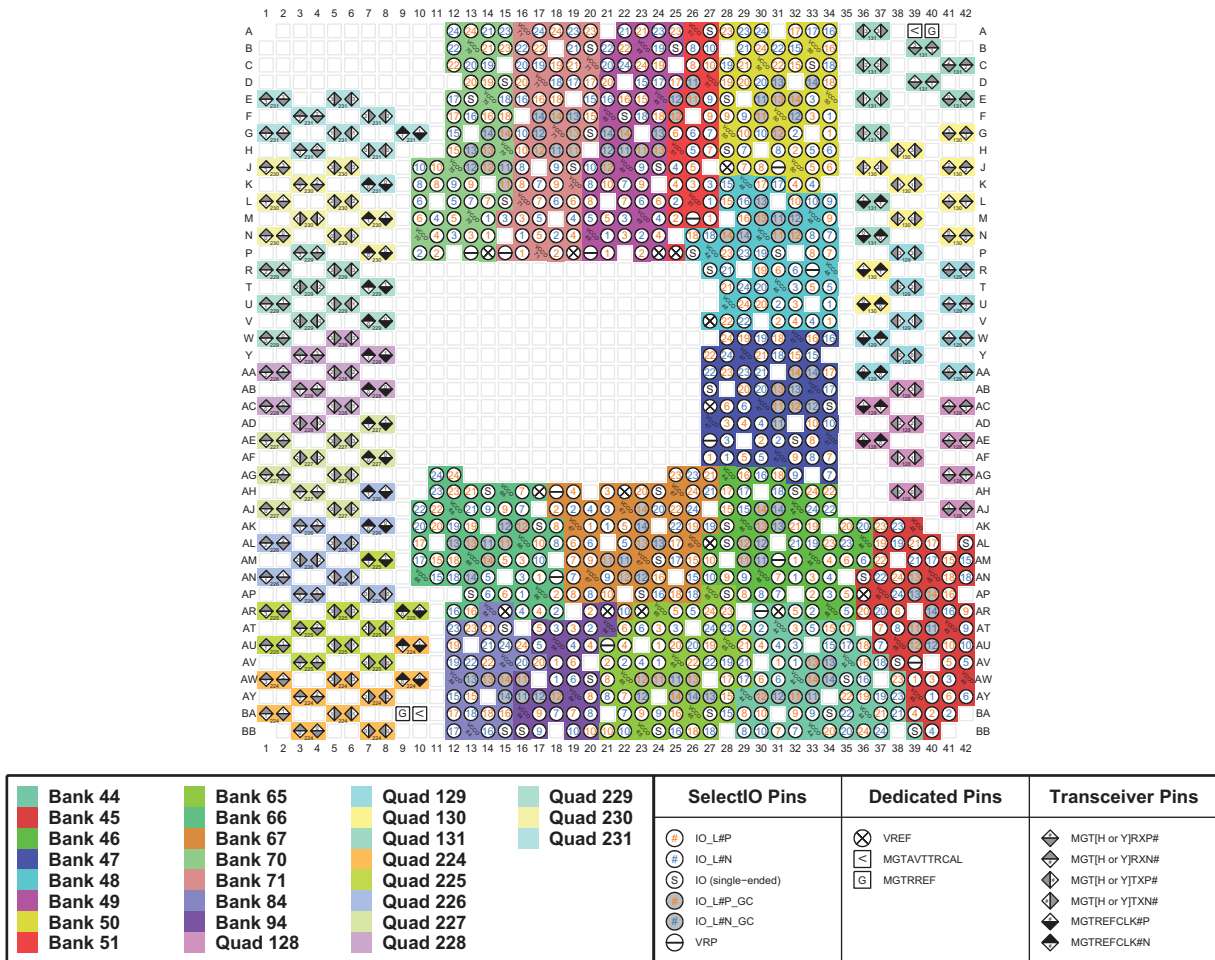

Figure 3-50: FLVD1517 Package—XCVU125 Configuration/Power Diagram

FFVB1760 (XCVU080 and XCVU095)



ug575_c3_51_100815

Figure 3-51: FFVB1760 Package—XCVU080 and XCVU095 I/O Bank Diagram

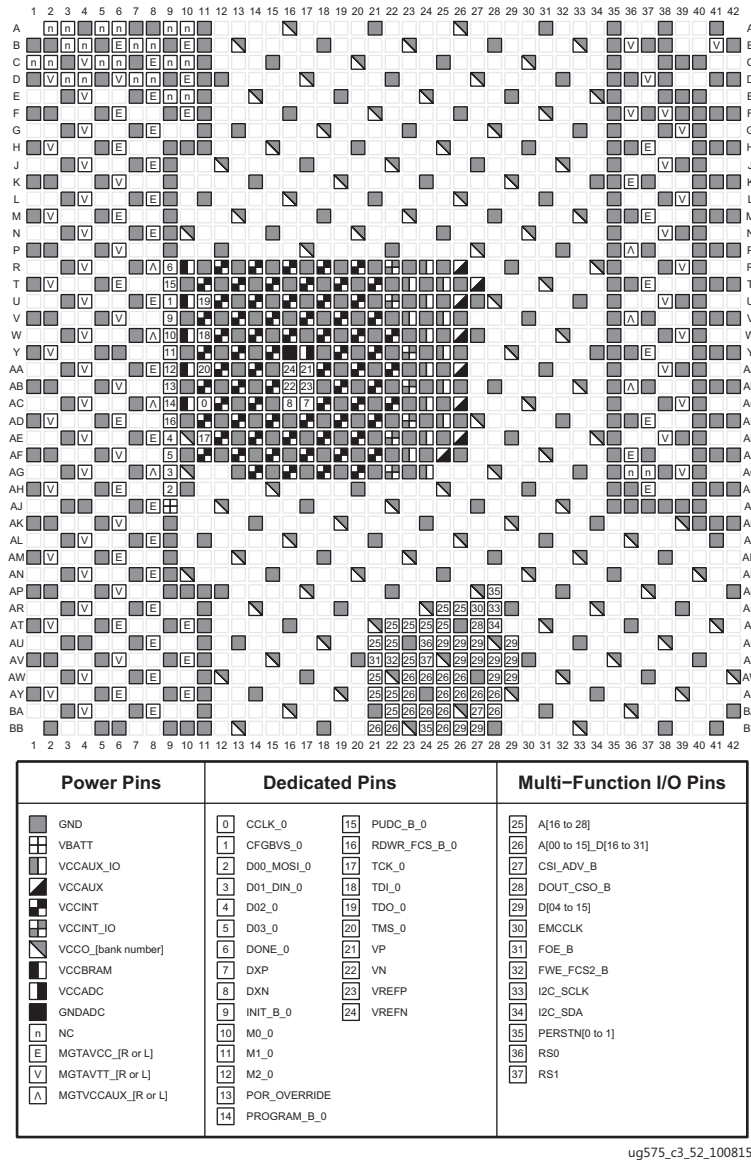

ug575_c3_52_100815

Figure 3-52: FFVB1760 Package—XCVU080 and XCVU095 Configuration/Power Diagram

FLVB1760 (XCVU125)

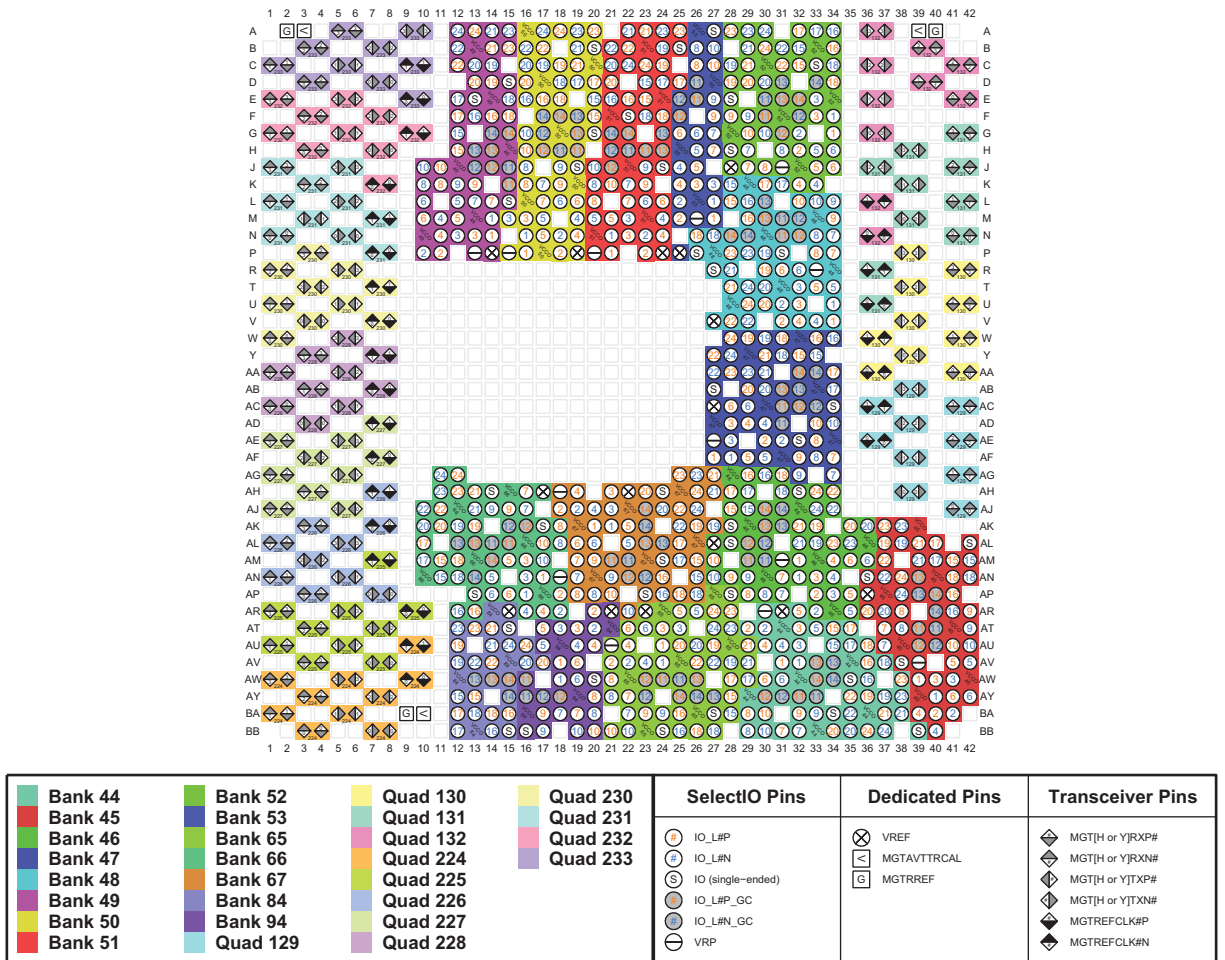

ug575_c3_53_100815

Figure 3-53: FLVB1760 Package—XCVU125 I/O Bank Diagram

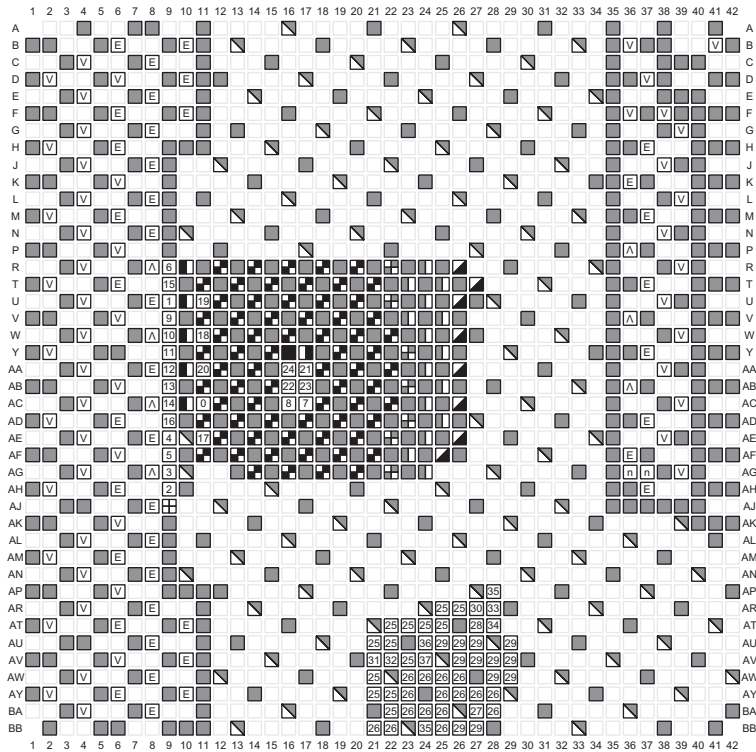

Power Pins	Dedicated Pins	Multi-Function I/O Pins
GND	0 CCLK_0	25 A[16 to 28]
VBATT	1 CFGBVS_0	26 A[0 to 15], D[16 to 31]
VCCAUX_IO	2 D00_MOSI_0	27 CSI_ADV_B
VCCAUX	3 D01_DIN_0	28 DOUT_CSO_B
VCCINT	4 D02_0	29 D[04 to 15]
VCCINT_IO	5 D03_0	30 EMCCLK
VCCO_[bank number]	6 DONE_0	31 F0E_B
VCCBRAM	7 DXP	32 FWE_FCS2_B
VCCADC	8 DXN	33 I2C_SCLK
GNDADC	9 INIT_B_0	34 I2C_SDA
h NC	10 M0_0	35 PERSTN[0 to 1]
E MGTAVCC_[R or L]	11 M1_0	36 RSO
V MGTAVTT_[R or L]	12 M2_0	37 RS1
A MGTVCCAUX_[R or L]	13 POR_OVERRIDE	
	14 PROGRAM_B_0	
	15 PUDC_B_0	
	16 RDWR_FCS_B_0	
	17 TCK_0	
	18 TDI_0	
	19 TDO_0	
	20 TMS_0	
	21 VP	
	22 VN	
	23 VREFP	
	24 VREFN	

ug575_c3_54_100815

Figure 3-54: FLVB1760 Package—XCVU125 Configuration/Power Diagram

FFVA2104 (XCVU080 and XCVU095)

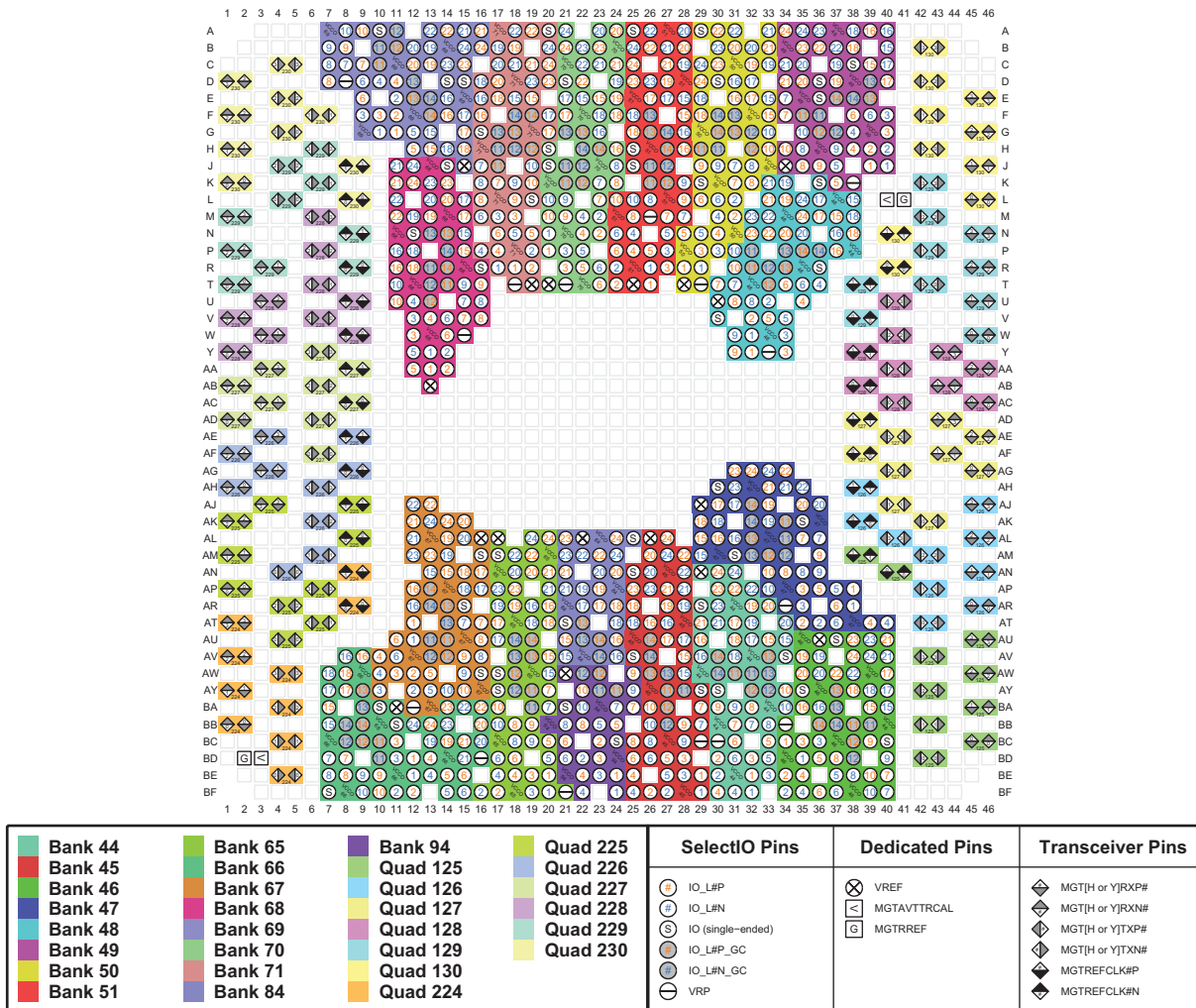

ug575_c3_55_100815

Figure 3-55: FFVA2104 Package—XCVU080 and XCVU095 I/O Bank Diagram

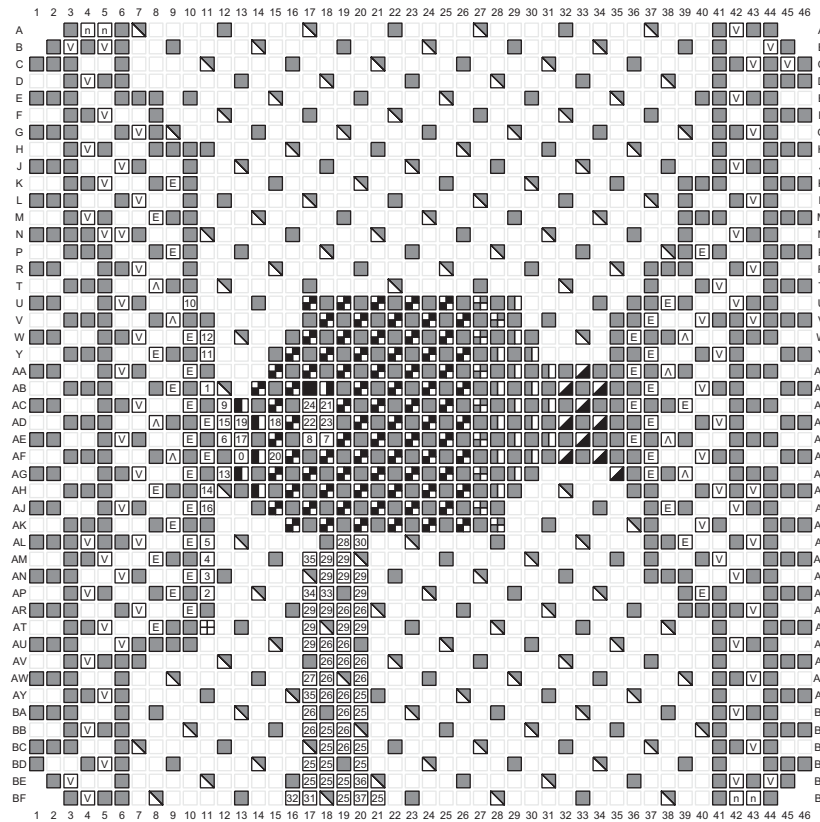

Power Pins	Dedicated Pins		Multi-Function I/O Pins
■ GND	0 CCLK_0	15 PUDC_B_0	25 A[16 to 28]
⊕ VBATT	1 CFGBVS_0	16 RDWR_FCS_B_0	26 A[00 to 15]_D[16 to 31]
▢ VCCAUX_IO	2 D00_MOSI_0	17 TCK_0	27 CSI_ADV_B
▣ VCCAUX	3 D01_DIN_0	18 TDI_0	28 DOUT_CSO_B
▤ VCCINT	4 D02_0	19 TDO_0	29 D[04 to 15]
▥ VCCINT_IO	5 D03_0	20 TMS_0	30 EMCLK
▦ VCCO_[bank number]	6 DONE_0	21 VP	31 FOE_B
▧ VCCBRAM	7 DXP	22 VN	32 FWE_FCS2_B
▨ VCCADC	8 DXN	23 VREFP	33 I2C_SCLK
▩ GNDADC	9 INIT_B_0	24 VREFN	34 I2C_SDA
▫ NC	10 M0_0		35 PERSTN[0 to 1]
▬ MGTAVCC_[R or L]	11 M1_0		36 RS0
▭ MGTAVTT_[R or L]	12 M2_0		37 RS1
▮ MGTVCCAUX_[R or L]	13 POR_OVERRIDE		
	14 PROGRAM_B_0		

ug575_c3_56_100815

Figure 3-56: FFVA2104 Package—XCVU080 and XCVU095 Configuration/Power Diagram

FLVA2104 (XCVU125)

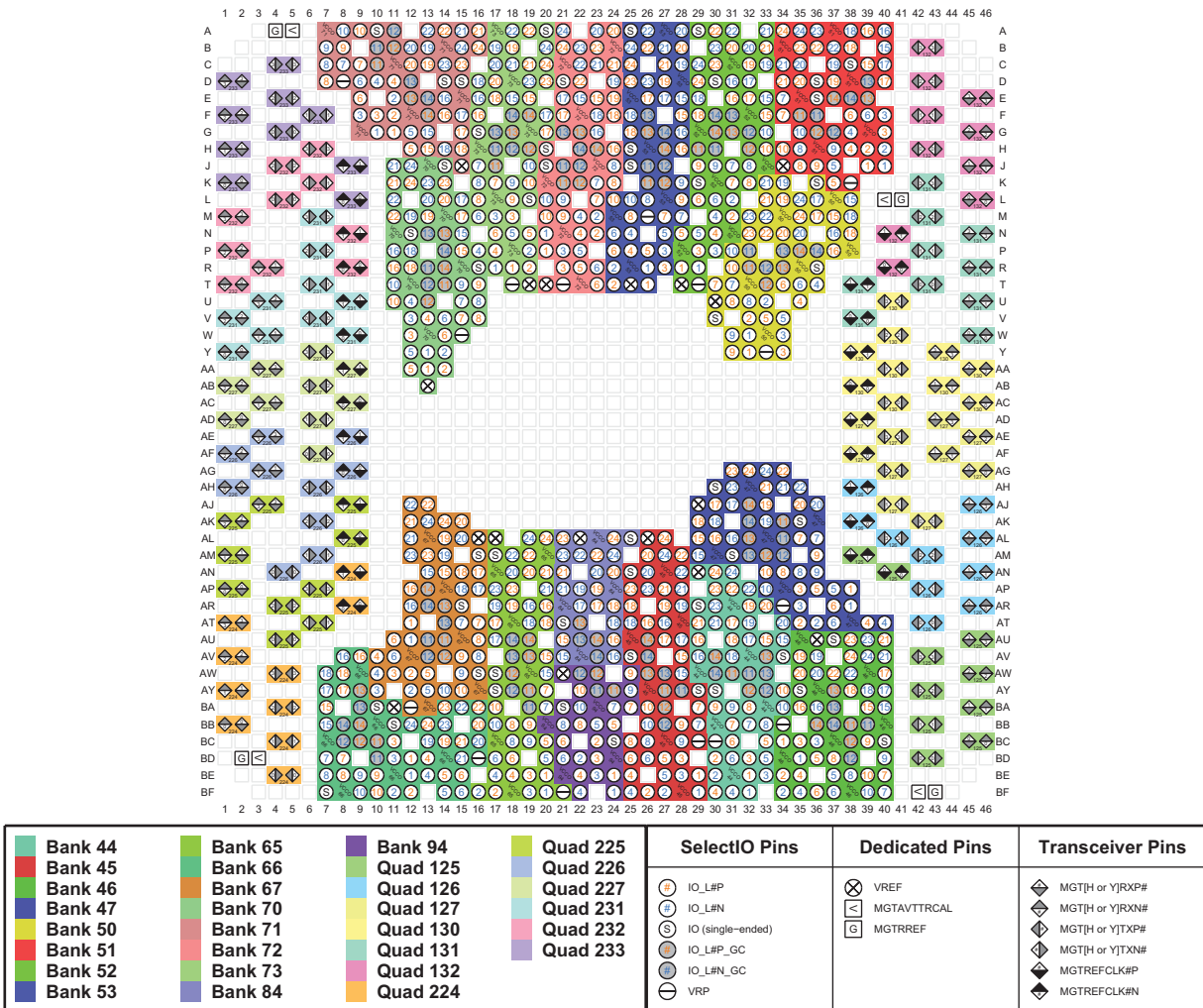

ug575_c3_57_100815

Figure 3-57: FLVA2104 Package—XCVU125 I/O Bank Diagram

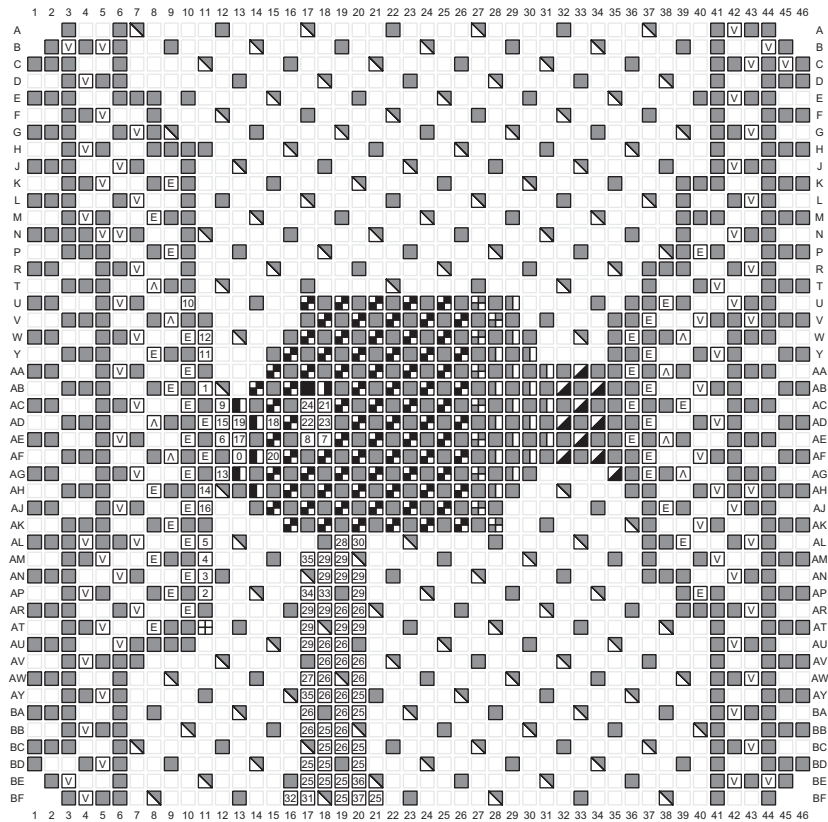

Power Pins	Dedicated Pins	Multi-Function I/O Pins
GND	0 CCLK_0	25 A[16 to 28]
VBATT	1 CFGBVS_0	26 A[00 to 15]_D[16 to 31]
VCCAUX_IO	2 D00_MOSI_0	27 CSI_ADV_B
VCCAUX	3 D01_DIN_0	28 DOUT_CSO_B
VCCINT	4 D02_0	29 D[04 to 15]
VCCINT_IO	5 D03_0	30 EMCLK
VCCO_[bank number]	6 DONE_0	31 FOE_B
VCCBRAM	7 DXP	32 FWE_FCS2_B
VCCADC	8 DXN	33 I2C_SCLK
GNDADC	9 INIT_B_0	34 I2C_SDA
n NC	10 M0_0	35 PERSTN[0 to 1]
E MGTAVCC_[R or L]	11 M1_0	36 RSO
V MGTAVTT_[R or L]	12 M2_0	37 RS1
A MGTVCCAUX_[R or L]	13 POR_OVERRIDE	
	14 PROGRAM_B_0	
	15 PUDC_B_0	
	16 RDWR_FCS_B_0	
	17 TCK_0	
	18 TDI_0	
	19 TDO_0	
	20 TMS_0	
	21 VP	
	22 VN	
	23 VREFP	
	24 VREFN	

ug575_c3_58_100815

Figure 3-58: FLVA2104 Package—XCVU125 Configuration/Power Diagram

FFVB2104 (XCVU080 and XCVU095)

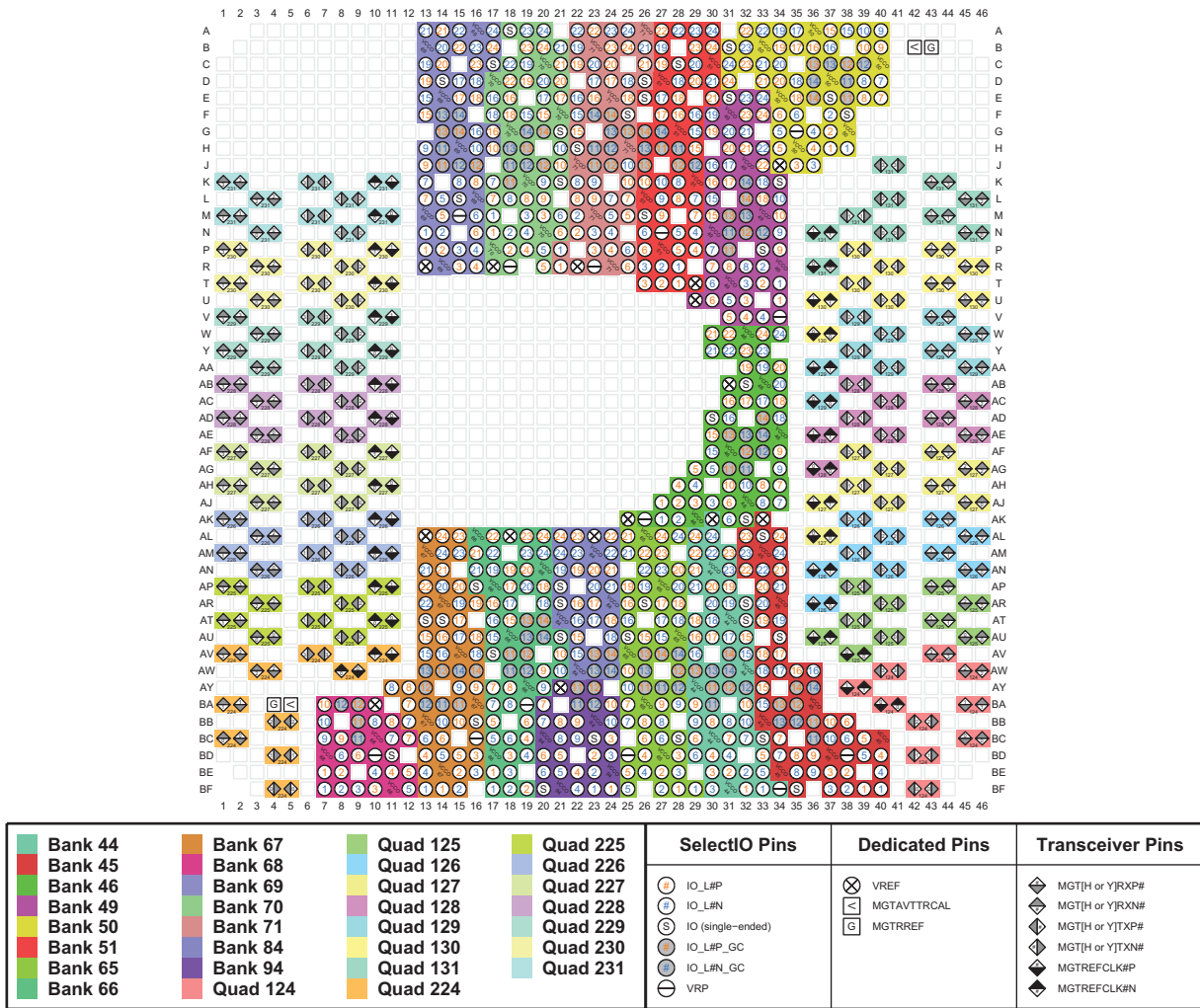

ug575_c3_59_100815

Figure 3-59: FFVB2104 Package—XCVU080 and XCVU095 I/O Bank Diagram

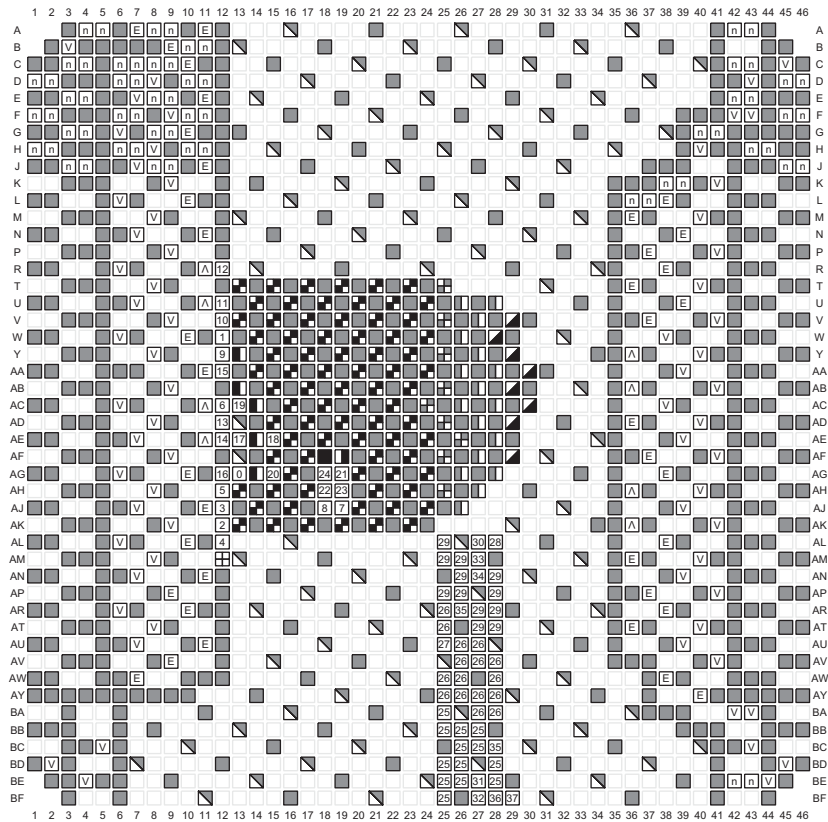

Power Pins	Dedicated Pins		Multi-Function I/O Pins
GND	0 CCLK_0	15 PUDC_B_0	25 A[16 to 28]
VBATT	1 CFGBVS_0	16 RDWR_FCS_B_0	26 A[00 to 15]_D[16 to 31]
VCCAUX_IO	2 D00_MOSI_0	17 TCK_0	27 CSI_ADV_B
VCCAUX	3 D01_DIN_0	18 TDI_0	28 DOUT_CSO_B
VCCINT	4 D02_0	19 TDO_0	29 D[04 to 15]
VCCINT_IO	5 D03_0	20 TMS_0	30 EMCCLK
VCCO_[bank number]	6 DONE_0	21 VP	31 FOE_B
VCCBRAM	7 DXP	22 VN	32 FWE_FCS2_B
VCCADC	8 DXN	23 VREFP	33 I2C_SCLK
GNDADC	9 INIT_B_0	24 VREFN	34 I2C_SDA
NC	10 M0_0		35 PERSTN[0 to 1]
MGTAVCC_[R or L]	11 M1_0		36 RS0
MGTAVTT_[R or L]	12 M2_0		37 RS1
MGTVCCAUX_[R or L]	13 POR_OVERRIDE		
	14 PROGRAM_B_0		

ug575_c3_60_100815

Figure 3-60: FFVB2104 Package—XCVU080 and XCVU095 Configuration/Power Diagram

FLVB2104 (XCVU125)

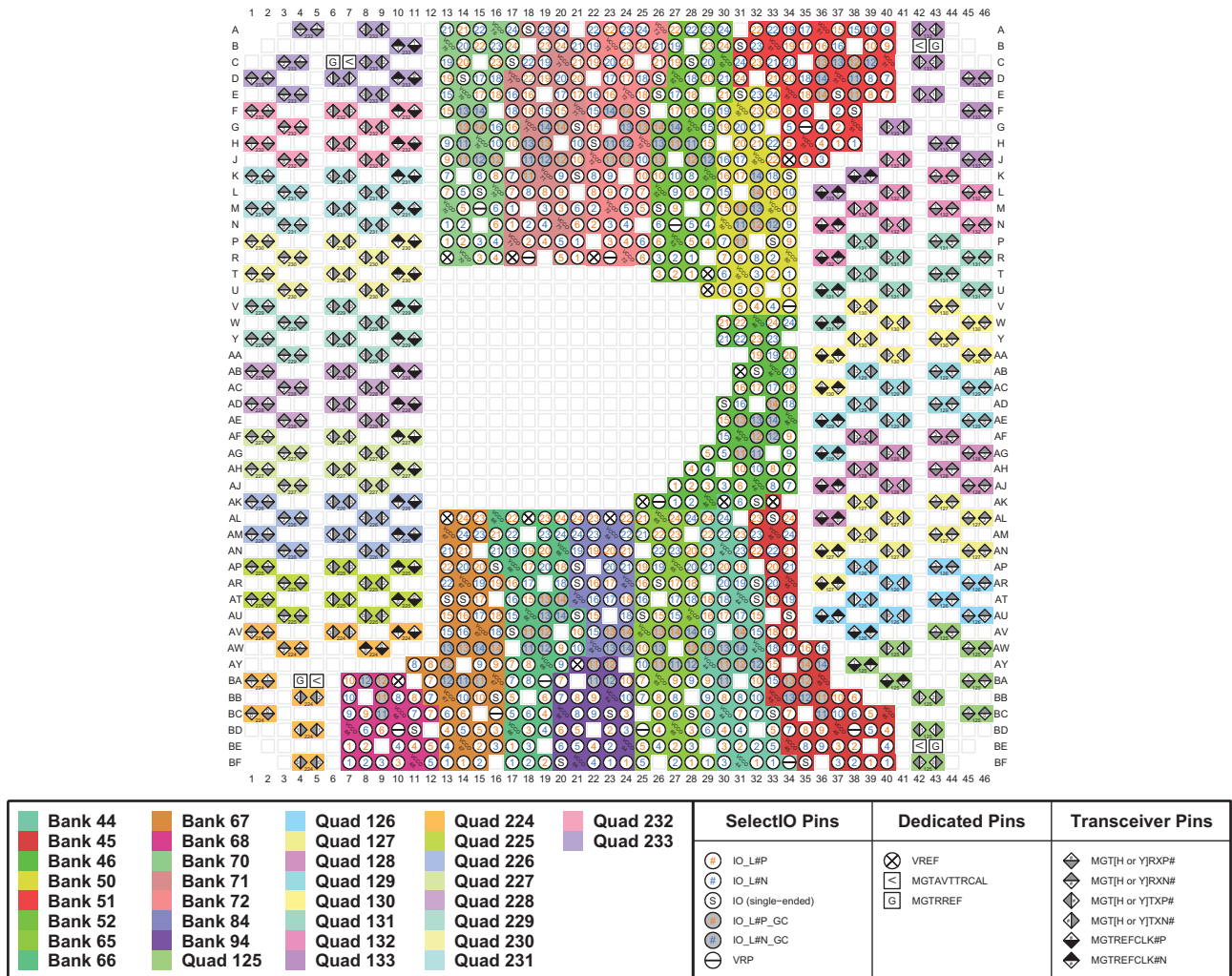

ug575_c3_61_100815

Figure 3-61: FLVB2104 Package—XCVU125 I/O Bank Diagram

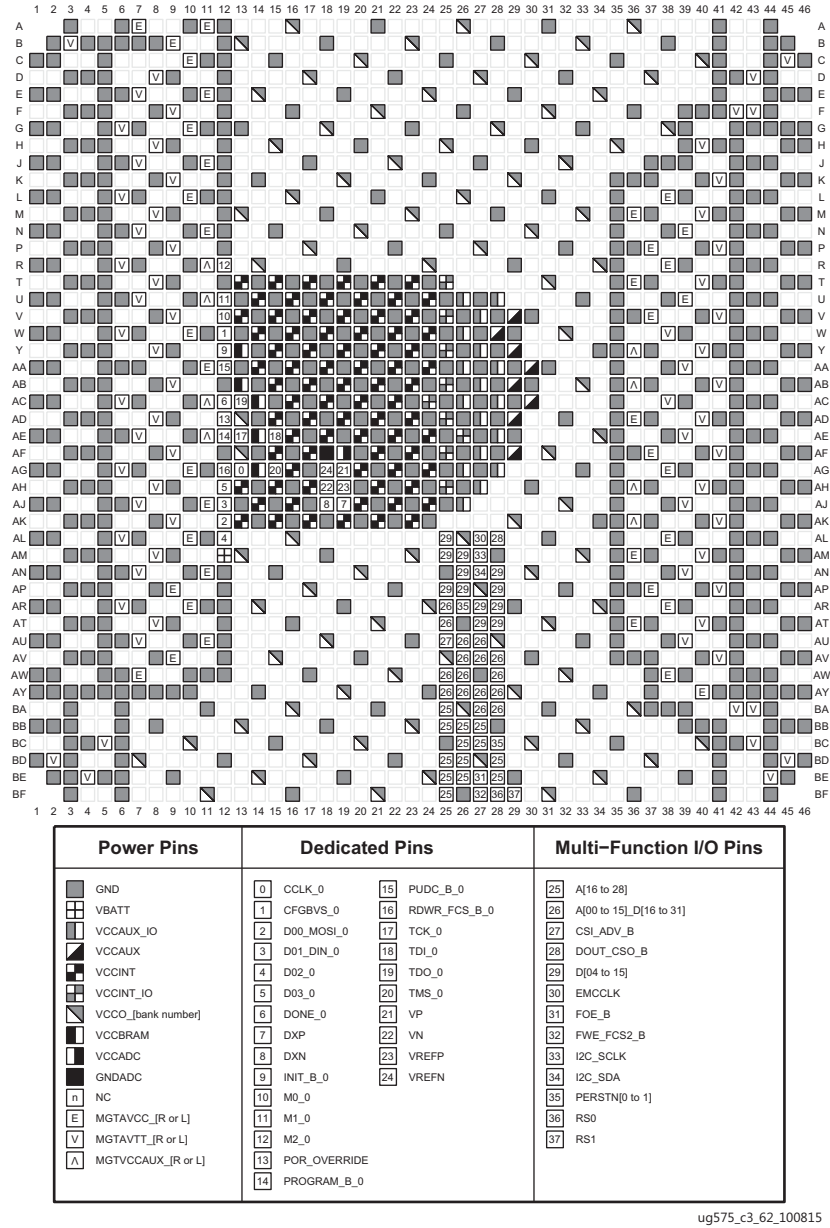
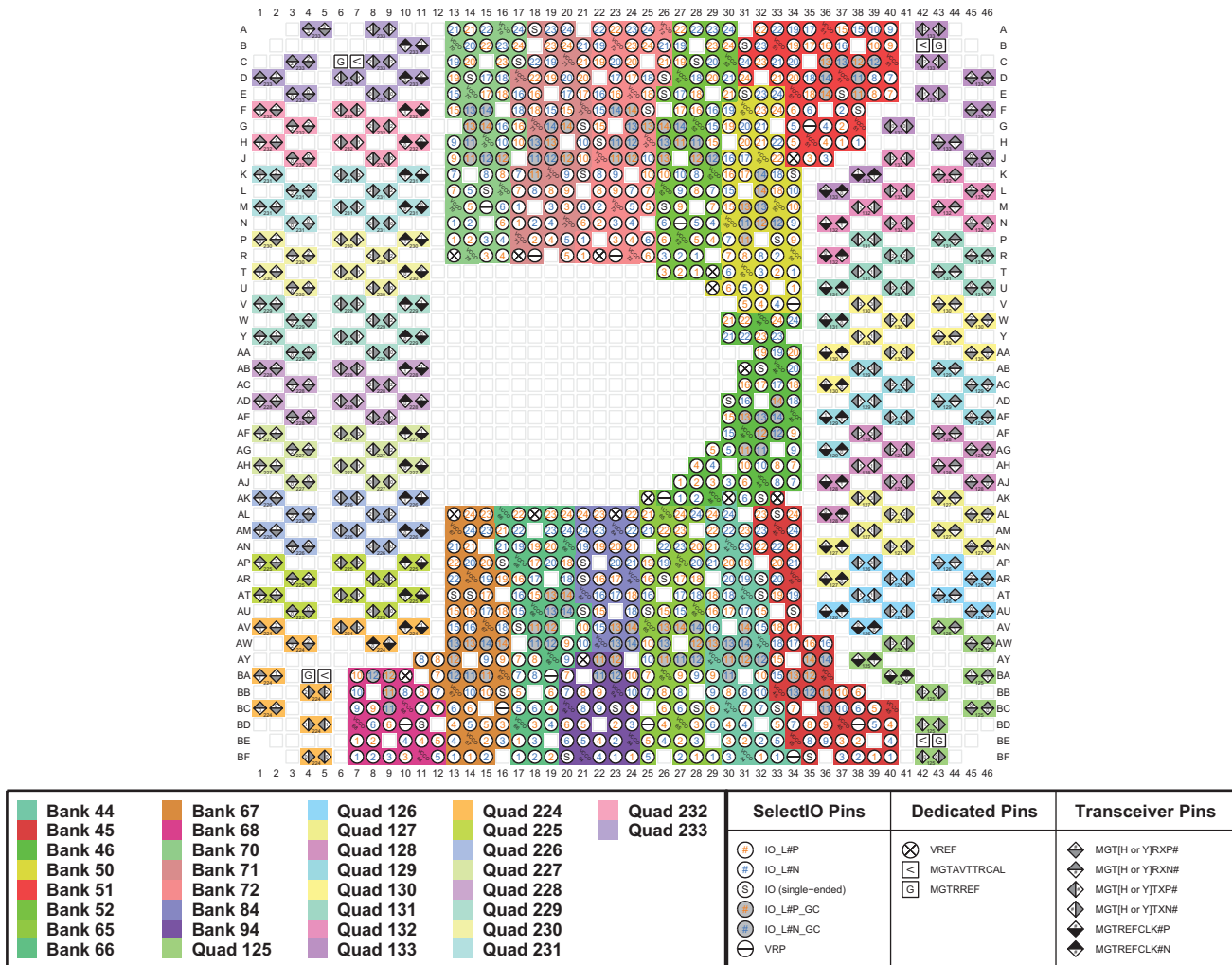

Figure 3-62: FLVB2104 Package—XCVU125 Configuration/Power Diagram

FLGB2104 (XCVU160 and XCVU190)



ug575_c3_63_100815

Figure 3-63: FLGB2104 Package—XCVU160 and XCVU190 I/O Bank Diagram

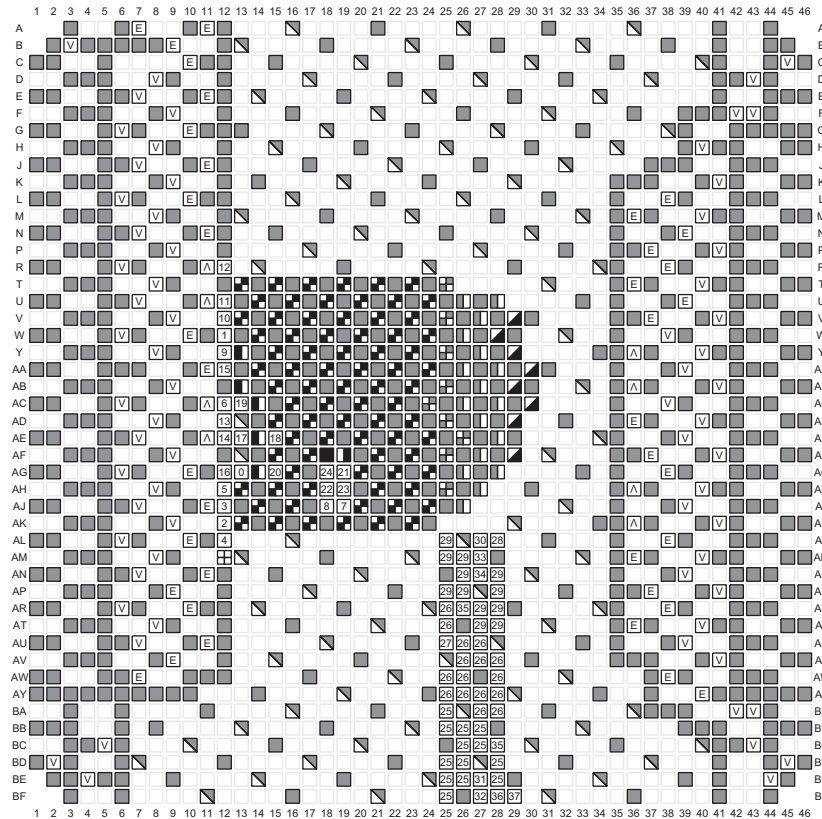

Power Pins	Dedicated Pins	Multi-Function I/O Pins
GND	0 CCLK_0	25 A[16 to 28]
VBATT	1 CFGBVS_0	26 A[00 to 15]_D[16 to 31]
VCCAUX_IO	2 D00_MOSI_0	27 CSI_ADV_B
VCCAUX	3 D01_DIN_0	28 DOUT_CSO_B
VCCINT	4 D02_0	29 D[04 to 15]
VCCINT_IO	5 D03_0	30 EMCCLK
VCCO [bank number]	6 DONE_0	31 FOE_B
VCCBRAM	7 DXP	32 FWE_FCS2_B
VCCADC	8 DXN	33 I2C_SCLK
GNDADC	9 INIT_B_0	34 I2C_SDA
NC	10 M0_0	35 PERSTN[0 to 1]
MGTAVCC [R or L]	11 M1_0	36 RSO
MGTAVTT [R or L]	12 M2_0	37 RS1
MGTVCCAUX [R or L]	13 POR_OVERRIDE	
	14 PROGRAM_B_0	
	15 PUDC_B_0	
	16 RDWR_FCS_B_0	
	17 TCK_0	
	18 TDI_0	
	19 TDO_0	
	20 TMS_0	
	21 VP	
	22 VN	
	23 VREFP	
	24 VREFN	

ug575_c3_64_100815

Figure 3-64: FLGB2104 Package—XCVU160 and XCVU190 Configuration/Power Diagram

FFVC2104 (XCVU095)

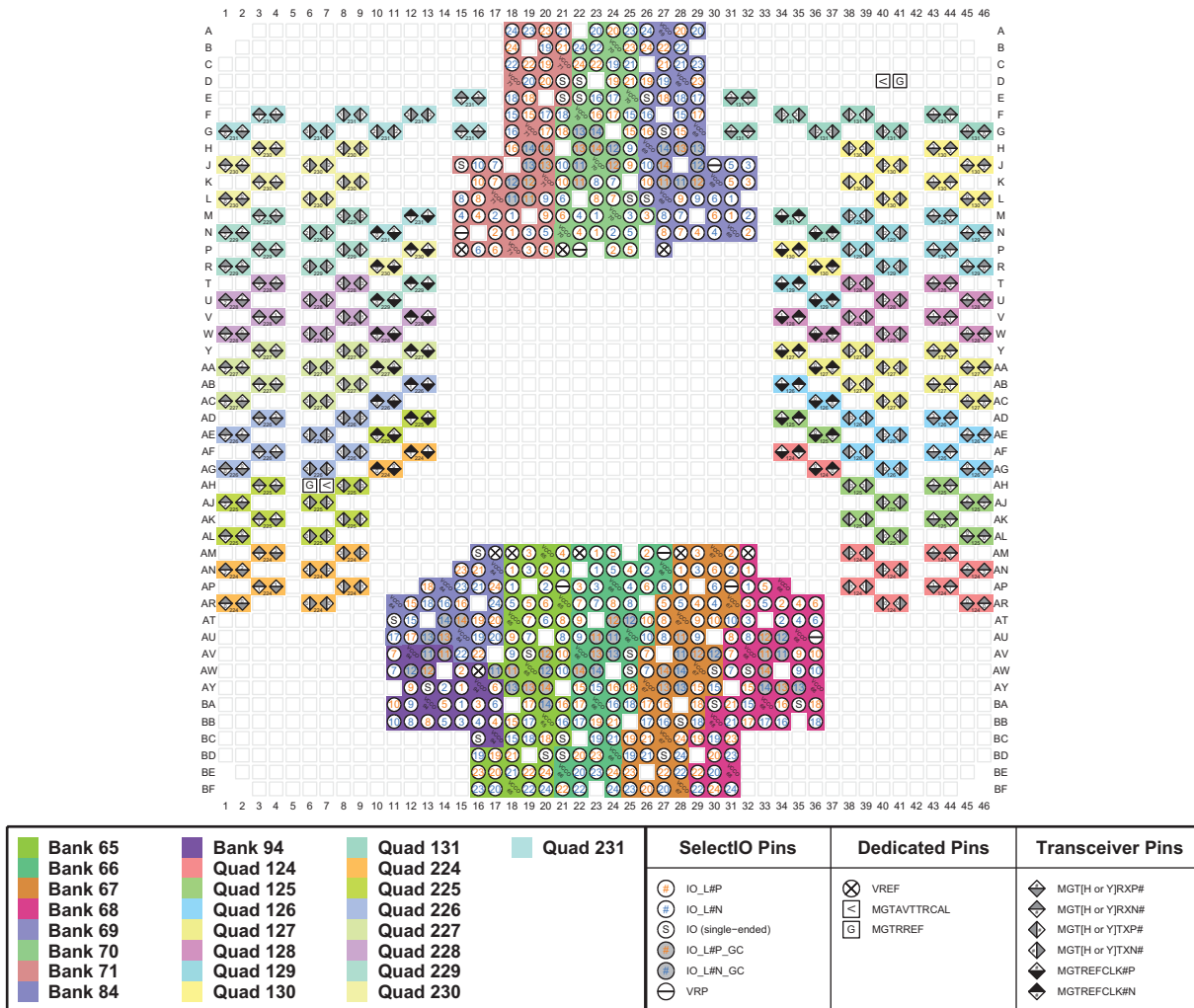

ug575_c3_65_100815

Figure 3-65: FFVC2104 Package—XCVU095 I/O Bank Diagram

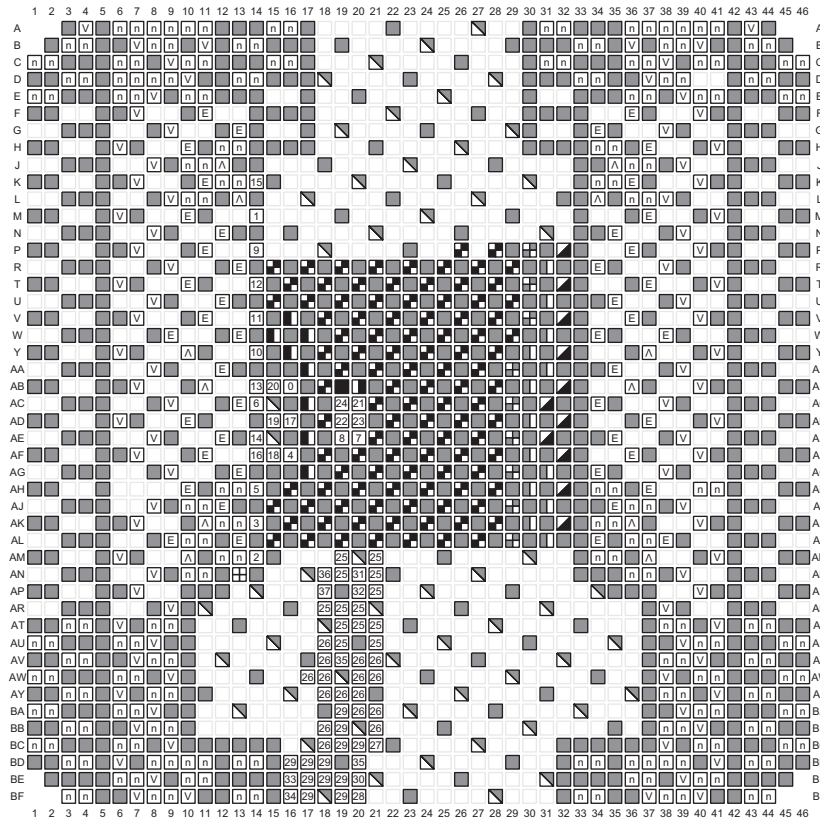

Power Pins	Dedicated Pins		Multi-Function I/O Pins
GND	0 CCLK_0	15 PUDC_B_0	25 A[16 to 28]
VBATT	1 CFGBVS_0	16 RDWR_FCS_B_0	26 A[00 to 15]_D[16 to 31]
VCCAUX_IO	2 D00_MOSI_0	17 TCK_0	27 CSI_ADV_B
VCCAUX	3 D01_DIN_0	18 TDI_0	28 DOUT_CSO_B
VCCINT	4 D02_0	19 TDO_0	29 D[04 to 15]
VCCINT_IO	5 D03_0	20 TMS_0	30 EMCCLK
VCCO [bank number]	6 DONE_0	21 VP	31 FOE_B
VCCBRAM	7 DXP	22 VN	32 FWE_FCS2_B
VCCADC	8 DXN	23 VREFF	33 I2C_SCLK
GNDADC	9 INIT_B_0	24 VREFN	34 I2C_SDA
NC	10 M0_0		35 PERSTN[0 to 1]
MGTAVCC [R or L]	11 M1_0		36 RSO
MGTAVTT [R or L]	12 M2_0		37 RS1
MGTVCCAUX [R or L]	13 POR_OVERRIDE		
	14 PROGRAM_B_0		

ug575_c3_66_100815

Figure 3-66: FFVC2104 Package—XCVU095 Configuration/Power Diagram

FLVC2104 (XCVU125)

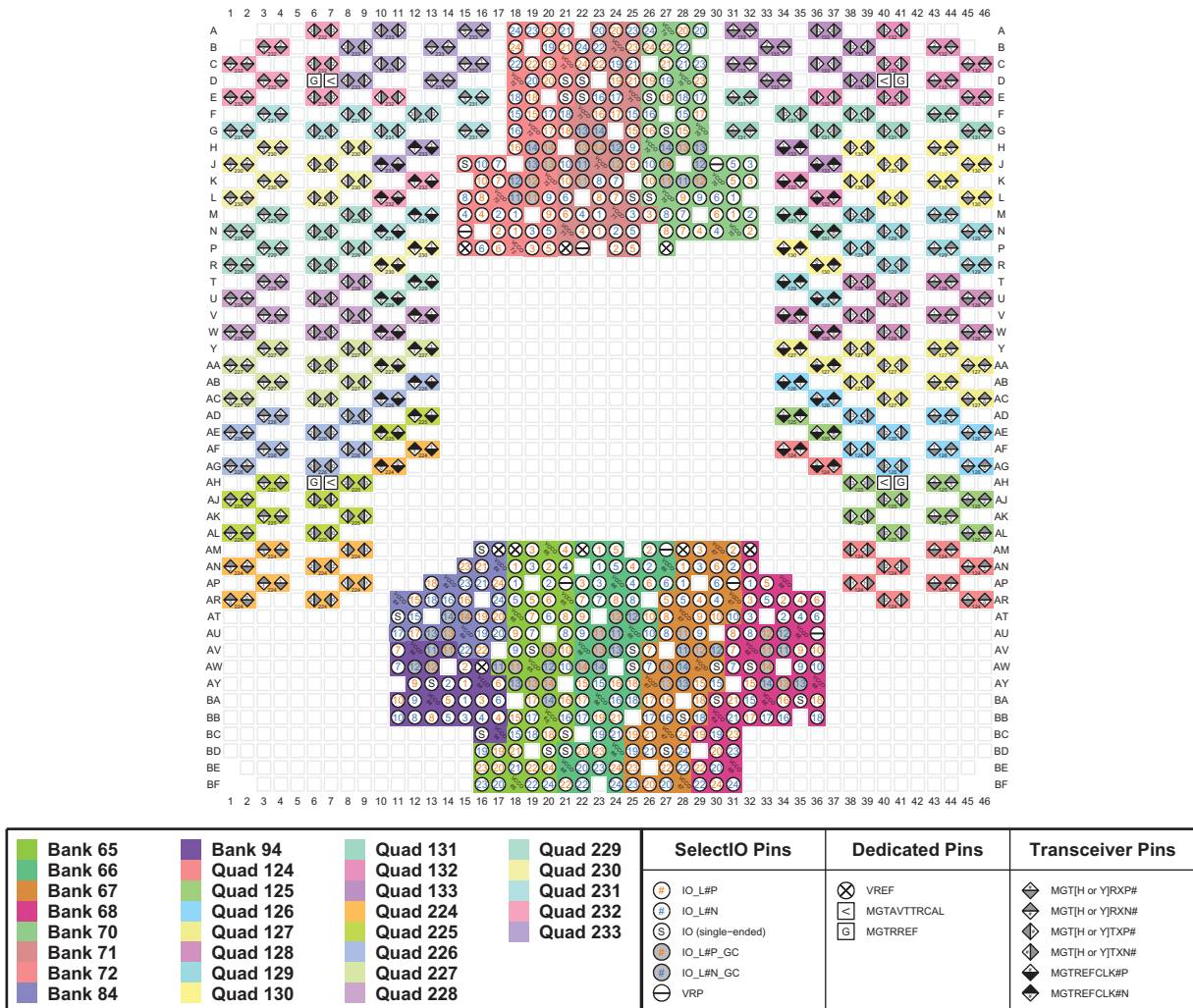

ug575_c3_67_100815

Figure 3-67: FLVC2104 Package—XCVU125 I/O Bank Diagram

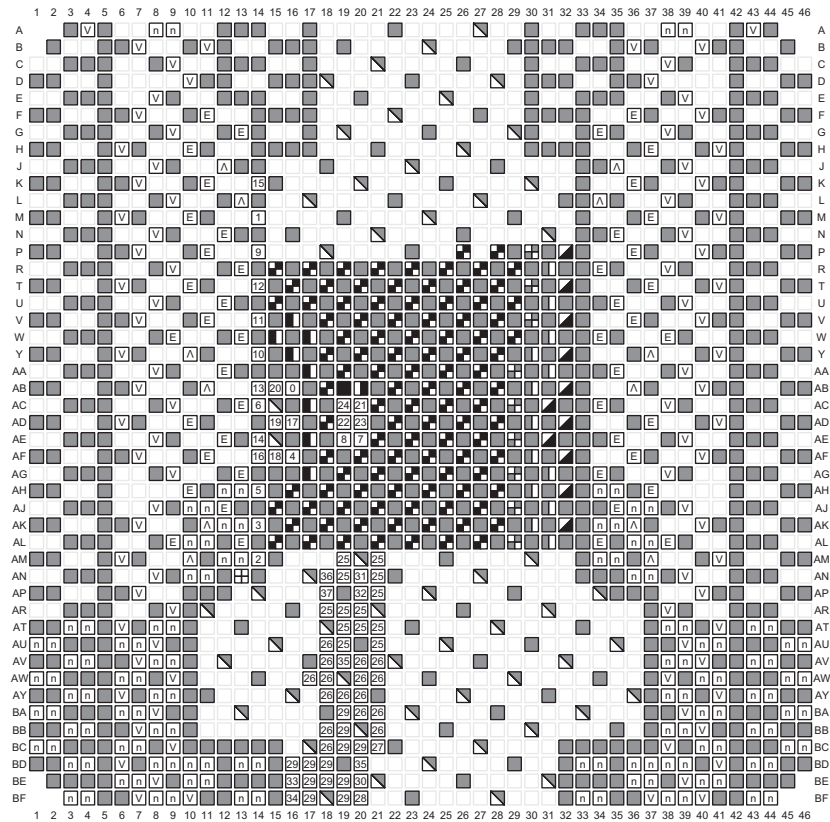

Power Pins	Dedicated Pins	Multi-Function I/O Pins
<ul style="list-style-type: none"> GND VBATT VCCAUX_IO VCCAUX VCCINT VCCINT_IO VCCO_[bank number] VCCBRAM VCCADC GNDADC NC MGTAVCC_[R or L] MGTAVTT_[R or L] MGTVCCAUX_[R or L] 	<ul style="list-style-type: none"> 0 CCLK_0 1 CFGBVS_0 2 D00_MOSI_0 3 D01_DIN_0 4 D02_0 5 D03_0 6 DONE_0 7 DXP 8 DXN 9 INIT_B_0 10 M0_0 11 M1_0 12 M2_0 13 POR_OVERRIDE 14 PROGRAM_B_0 15 PUDC_B_0 16 RDWR_FCS_B_0 17 TCK_0 18 TDI_0 19 TDO_0 20 TMS_0 21 VP 22 VN 23 VREFP 24 VREFN 	<ul style="list-style-type: none"> 25 A[16 to 28] 26 A[00 to 15]_D[16 to 31] 27 CSI_ADV_B 28 DOUT_CSO_B 29 D[04 to 15] 30 EMCCLK 31 FOE_B 32 FWE_FCS2_B 33 I2C_SCLK 34 I2C_SDA 35 PERSTN[0 to 1] 36 RSO 37 RS1

ug575_c3_68_100815

Figure 3-68: FLVC2104 Package—XCVU125 Configuration/Power Diagram

FLGC2104 (XCVU160 and XCVU190)

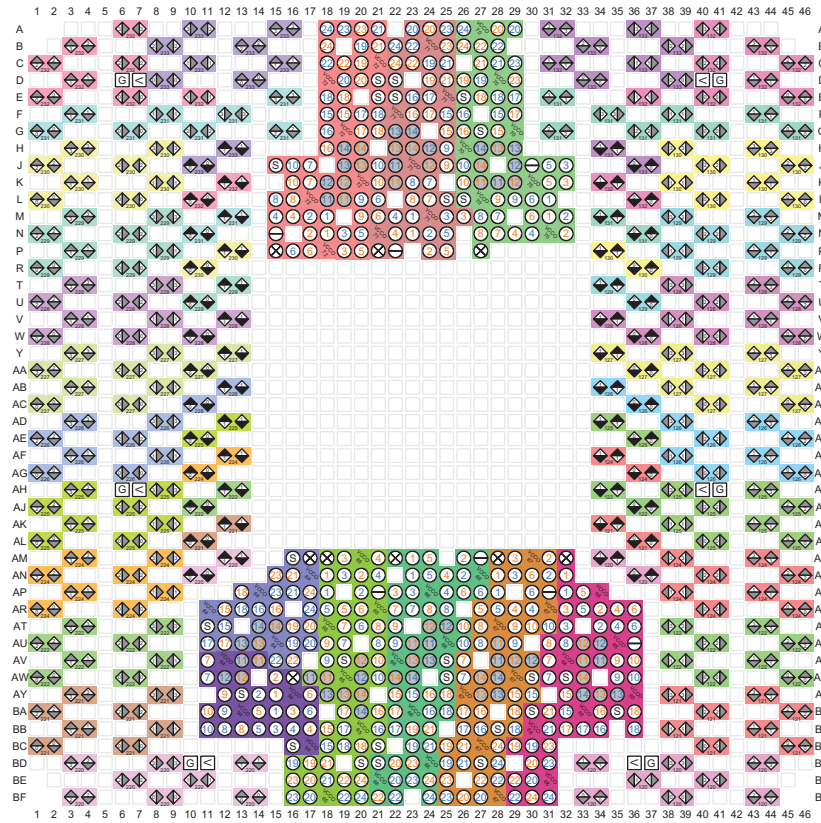

<ul style="list-style-type: none"> ■ Bank 65 ■ Bank 66 ■ Bank 67 ■ Bank 68 ■ Bank 70 ■ Bank 71 ■ Bank 72 ■ Bank 84 	<ul style="list-style-type: none"> ■ Bank 94 ■ Quad 120 ■ Quad 121 ■ Quad 122 ■ Quad 124 ■ Quad 125 ■ Quad 126 ■ Quad 127 	<ul style="list-style-type: none"> ■ Quad 128 ■ Quad 129 ■ Quad 130 ■ Quad 131 ■ Quad 132 ■ Quad 133 ■ Quad 220 ■ Quad 221 	<ul style="list-style-type: none"> ■ Quad 222 ■ Quad 224 ■ Quad 225 ■ Quad 226 ■ Quad 227 ■ Quad 228 ■ Quad 229 ■ Quad 230 	<ul style="list-style-type: none"> ■ Quad 231 ■ Quad 232 ■ Quad 233 	SelectIO Pins <ul style="list-style-type: none"> IO_#P IO_#P IO_#N IO_#N IO IO (single-ended) IO_#P_GC IO_#P_GC IO_#N_GC IO_#N_GC VRP VRP 	Dedicated Pins <ul style="list-style-type: none"> VREF VREF MGTAVTTRCAL MGTAVTTRCAL MGTREF MGTREF 	Transceiver Pins <ul style="list-style-type: none"> MGTIH or YJRX# MGTIH or YJRX# MGTIN or YJRX# MGTIN or YJRX# MGTIH or YJTXP# MGTIH or YJTXP# MGTIN or YJTXN# MGTIN or YJTXN# MGTREFCLK#P MGTREFCLK#P MGTREFCLK#N MGTREFCLK#N
--	---	---	--	---	--	---	--

ug575_c3_69_100815

Figure 3-69: FLGC2104 Package—XCVU160 and XCVU190 I/O Bank Diagram

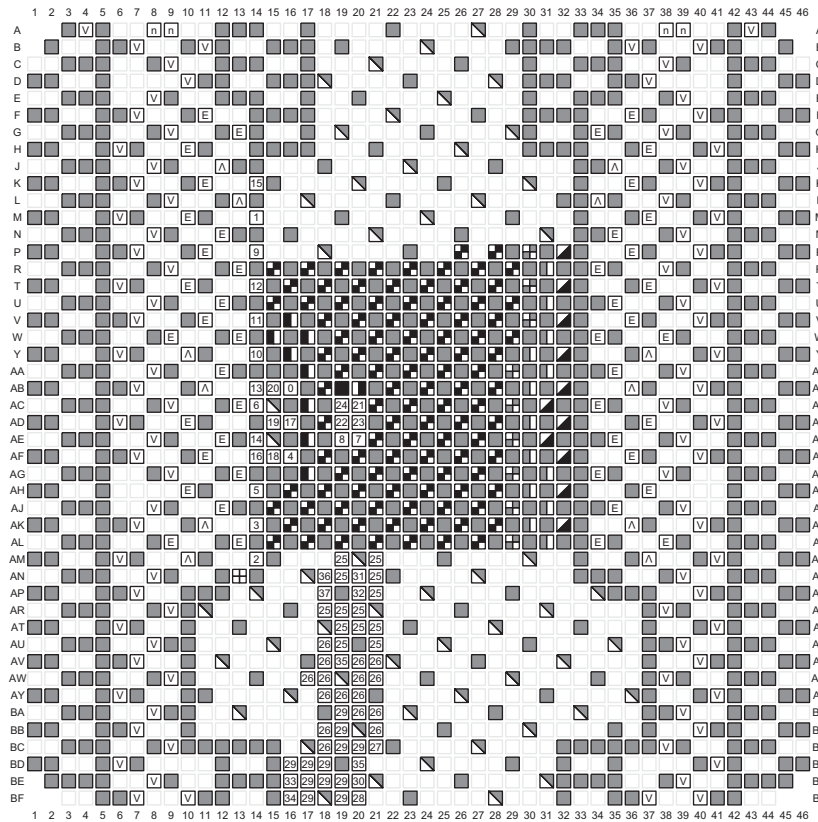

Power Pins	Dedicated Pins	Multi-Function I/O Pins
■ GND	0 CCLK_0	25 A[16 to 28]
⊕ VBAT	1 CFGBVS_0	26 A[00 to 15]_D[16 to 31]
▤ VCCAUX_IO	2 D00_MOSI_0	27 CSI_ADV_B
▥ VCCAUX	3 D01_DIN_0	28 DOUT_CSO_B
▦ VCCINT	4 D02_0	29 D[04 to 15]
▧ VCCINT_IO	5 D03_0	30 EMCCLK
▨ VCCO_[bank number]	6 DONE_0	31 FOE_B
▩ VCCBRAM	7 DXP	32 FWE_FCS2_B
▪ VCCADC	8 DXN	33 I2C_SCLK
▫ GNDADC	9 INIT_B_0	34 I2C_SDA
▬ NC	10 M0_0	35 PERSTN[0 to 1]
▭ MGTAVCC_[R or L]	11 M1_0	36 RS0
▮ MGTAVTT_[R or L]	12 M2_0	37 RS1
▯ MGTVCCAUX_[R or L]	13 POR_OVERRIDE	
	14 PROGRAM_B_0	
	15 PUDC_B_0	
	16 RDWR_FCS_B_0	
	17 TCK_0	
	18 TDI_0	
	19 TDO_0	
	20 TMS_0	
	21 VP	
	22 VN	
	23 VREFP	
	24 VREFN	

ug575_c3_70_100815

Figure 3-70: FLGC2104 Package—XCVU160 and XCVU190 Configuration/Power Diagram

FLGB2377 (XCVU440)

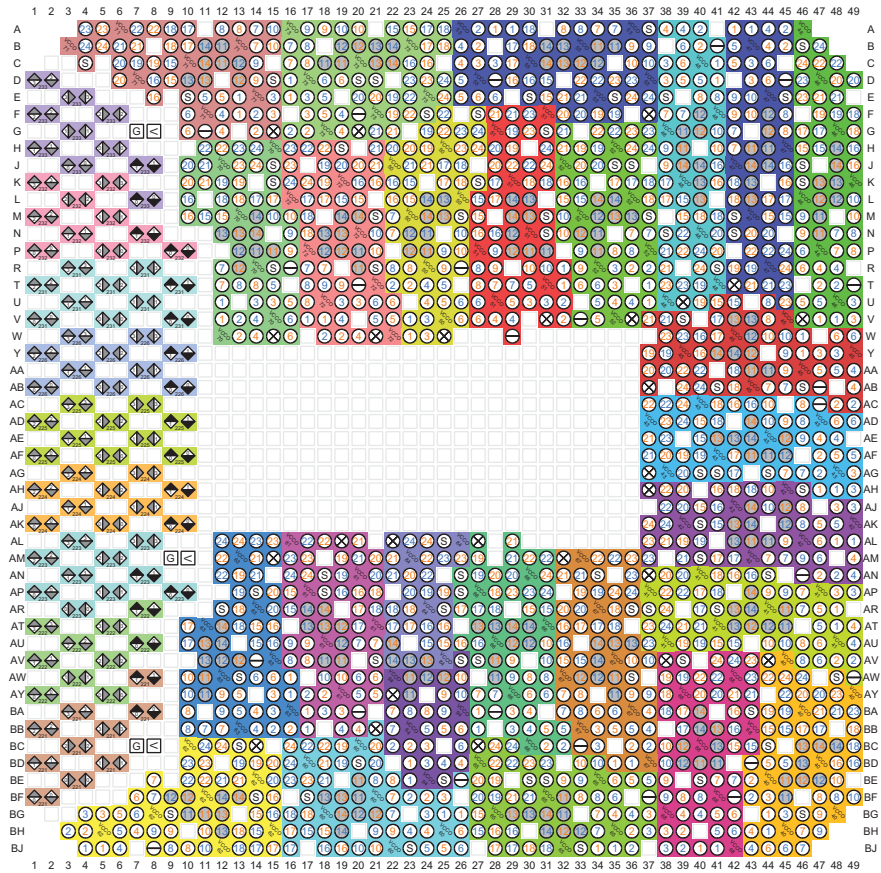

<ul style="list-style-type: none"> Bank 40 Bank 41 Bank 42 Bank 43 Bank 45 Bank 46 Bank 47 Bank 48 	<ul style="list-style-type: none"> Bank 50 Bank 51 Bank 52 Bank 60 Bank 61 Bank 62 Bank 63 	<ul style="list-style-type: none"> Bank 65 Bank 66 Bank 67 Bank 68 Bank 70 Bank 71 Bank 72 Bank 73 	<ul style="list-style-type: none"> Bank 84 Bank 94 Quad 221 Quad 222 Quad 223 Quad 224 Quad 225 Quad 226 	<ul style="list-style-type: none"> Quad 231 Quad 232 Quad 233 	SelectIO Pins <ul style="list-style-type: none"> IO_L#P IO_L#N IO (single-ended) IO_L#P_GC IO_L#N_GC VRP 	Dedicated Pins <ul style="list-style-type: none"> VREF MGTAVTTRCAL MGTREF 	Transceiver Pins <ul style="list-style-type: none"> MGT#H or #YRXP# MGT#H or #YRXN# MGT#H or #YTXP# MGT#H or #YT#N# MGTREFCLK#P MGTREFCLK#N
--	--	--	--	---	---	---	--

ug575_c3_71_100815

Figure 3-71: FLGB2377 Package—XCVU440 I/O Bank Diagram

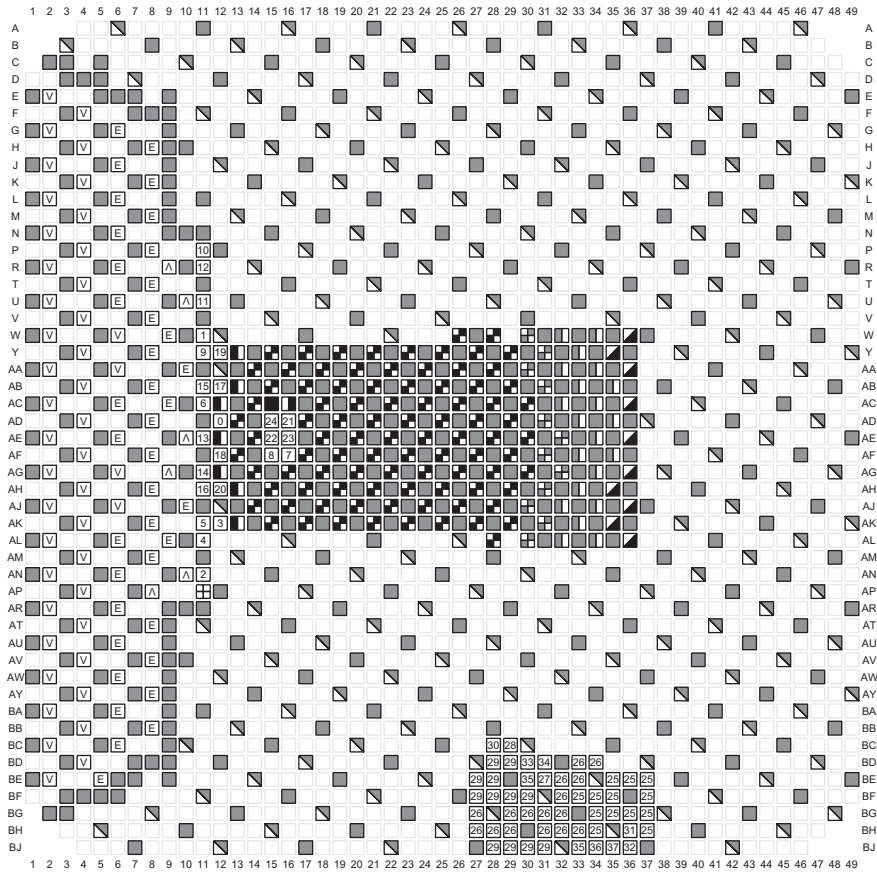

Power Pins	Dedicated Pins	Multi-Function I/O Pins
GND	0 CCLK_0	25 A[16 to 28]
VBATT	1 CFGBVS_0	26 A[0 to 15]_D[16 to 31]
VCCAUX_IO	2 D00_MOSI_0	27 CSI_ADV_B
VCCAUX	3 D01_DIN_0	28 DOUT_CSO_B
VCCINT	4 D02_0	29 D[04 to 15]
VCCINT_IO	5 D03_0	30 EMCCLK
VCCO_[bank number]	6 DONE_0	31 FOE_B
VCCBRAM	7 DXP	32 FWE_FCS2_B
VCCADC	8 DXN	33 I2C_SCLK
GNDADC	9 INIT_B_0	34 I2C_SDA
NC	10 M0_0	35 PERSTN[0 to 1]
MGTAVCC_[R or L]	11 M1_0	36 RS0
MGTAVTT_[R or L]	12 M2_0	37 RS1
MGTVCCAUX_[R or L]	13 POR_OVERRIDE	
	14 PROGRAM_B_0	
	15 PUDC_B_0	
	16 RDWR_FCS_B_0	
	17 TCK_0	
	18 TDI_0	
	19 TDO_0	
	20 TMS_0	
	21 VP	
	22 VN	
	23 VREFP	
	24 VREFN	

ug575_c3_72_100815

Figure 3-72: FLGB2377 Package—XCVU440 Configuration/Power Diagram

FLGA2577 (XCVU190)

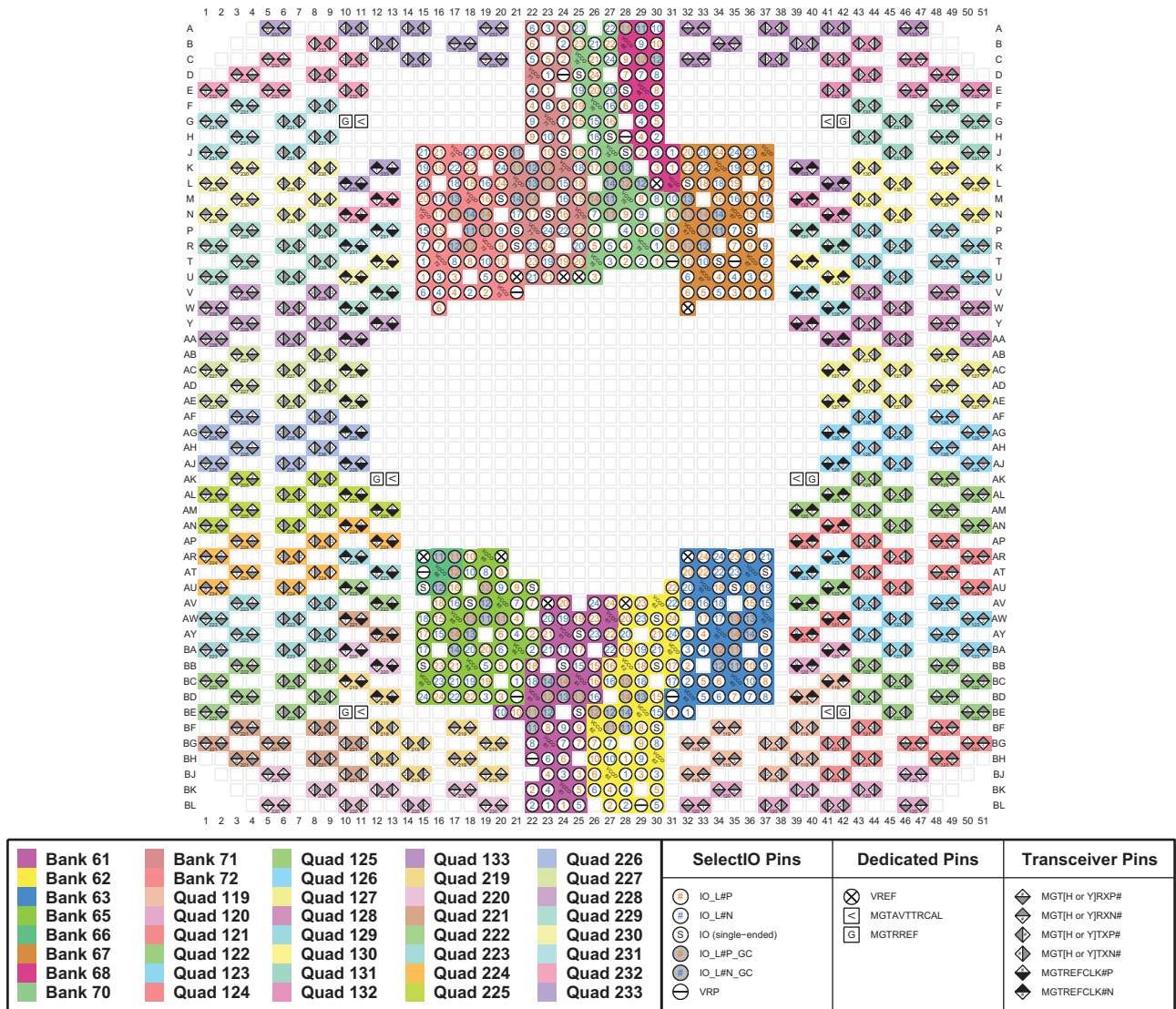

ug575_c3_73_100815

Figure 3-73: FLGA2577 Package—XCVU190 I/O Bank Diagram

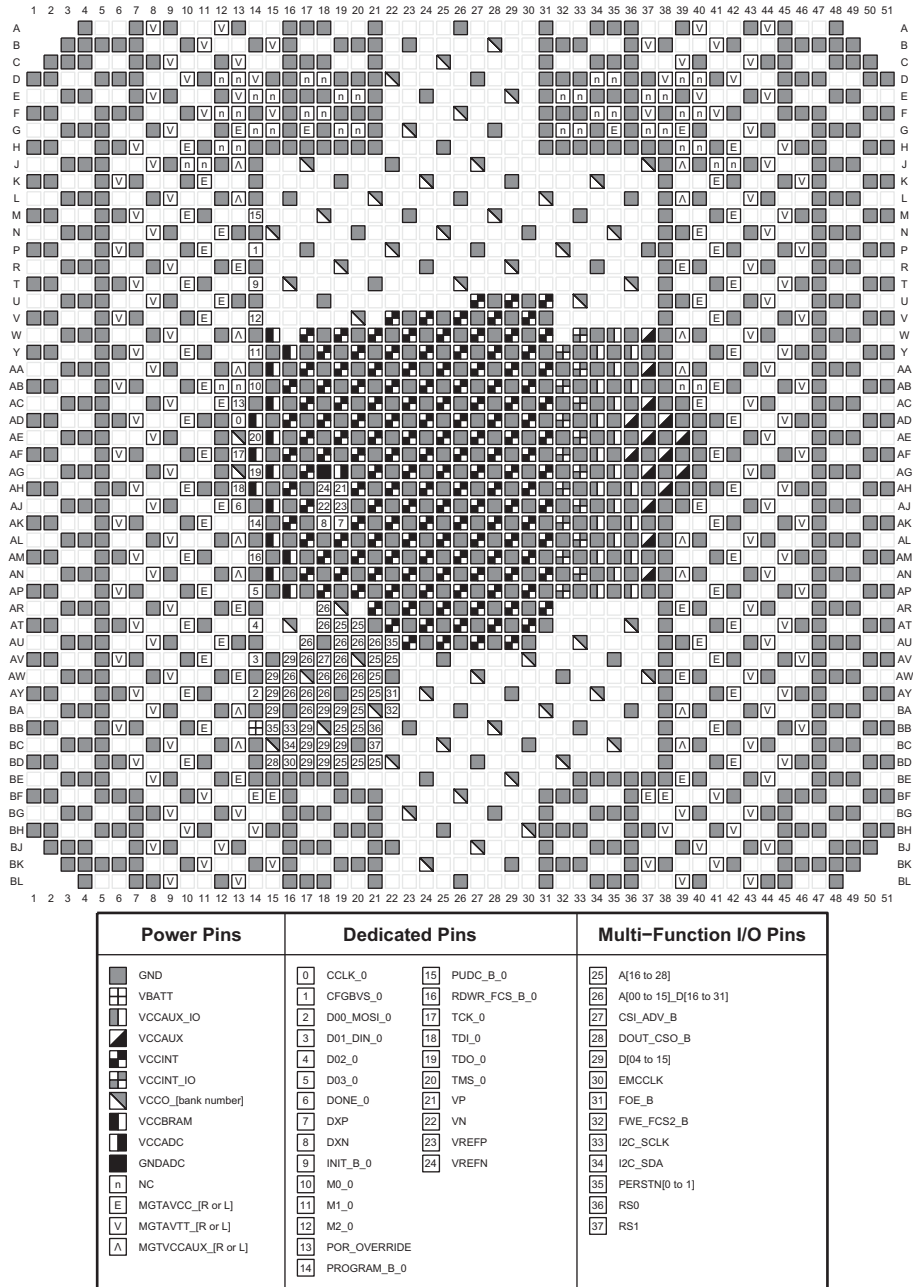

ug575_c3_74_100815

Figure 3-74: FLGA2577 Package—XCVU190 Configuration/Power Diagram

FLGA2892 (XCVU440)

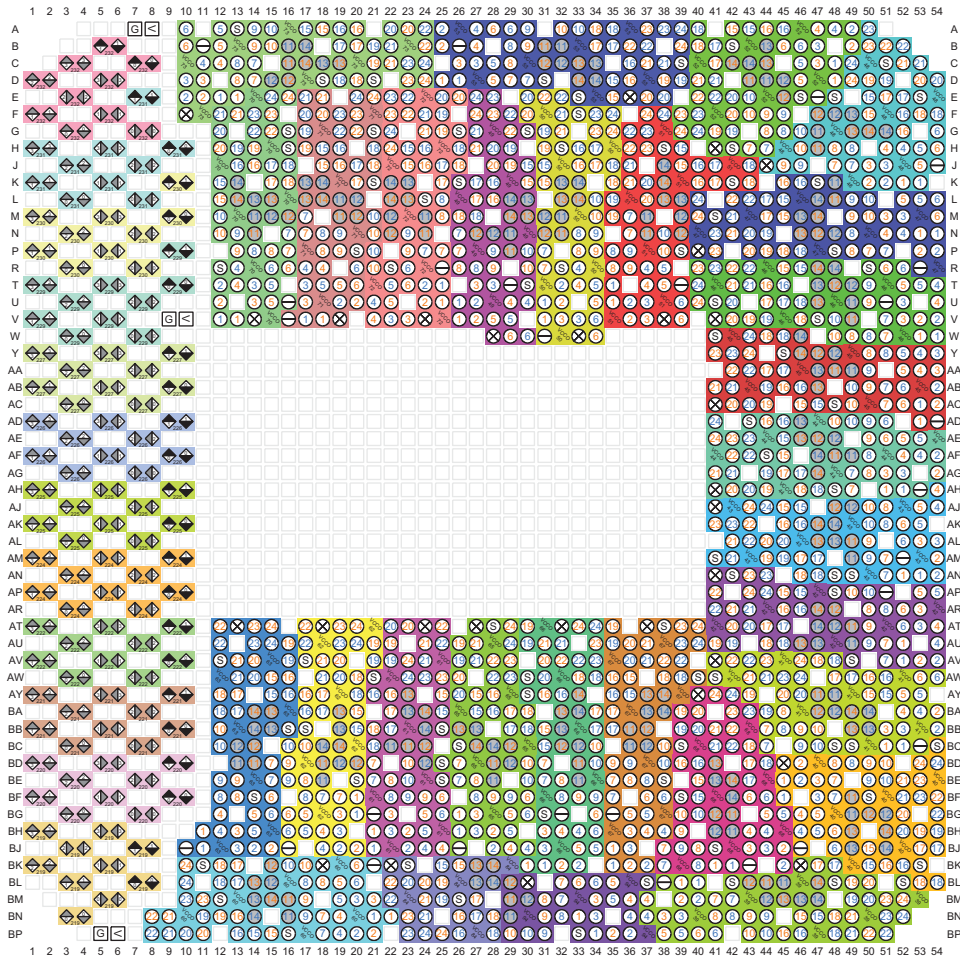

Bank 39	Bank 47	Bank 61	Bank 71	Quad 222	Quad 232	SelectIO Pins	Dedicated Pins	Transceiver Pins
Bank 40	Bank 48	Bank 62	Bank 72	Quad 224		IO_L#P	VREF	MGT[H or Y]RXP#
Bank 41	Bank 49	Bank 63	Bank 73	Quad 225		IO_L#N	MGTAVTTRCAL	MGT[H or Y]TXN#
Bank 42	Bank 50	Bank 65	Bank 74	Quad 226		IO (single-ended)	MGTTRREF	MGT[H or Y]TXP#
Bank 43	Bank 51	Bank 66	Bank 75	Quad 227		IO_L#P_GC		MGT[H or Y]TXN#
Bank 44	Bank 52	Bank 67	Bank 76	Quad 229		IO_L#N_GC		MGTREFCLK#P
Bank 45	Bank 53	Bank 68	Bank 77	Quad 230		VRP		MGTREFCLK#N
Bank 46	Bank 60	Bank 70	Quad 221	Quad 231				

ug575_c3_75_100815

Figure 3-75: FLGA2892 Package—XCVU440 I/O Bank Diagram

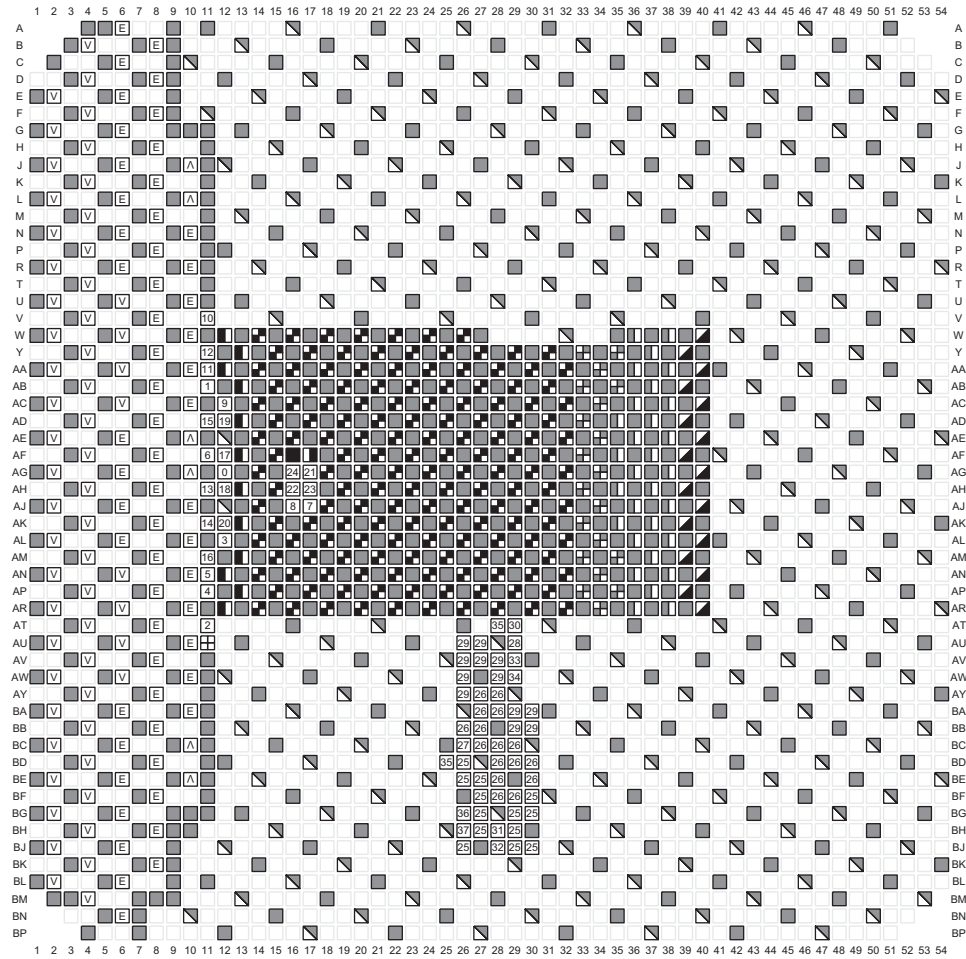

Power Pins	Dedicated Pins	Multi-Function I/O Pins
■ GND	0 CCLK_0	25 A[16 to 28]
⊕ VBAT	1 CFGBVS_0	26 A[00 to 15]_D[16 to 31]
▤ VCCAUX_IO	2 D00_MOSI_0	27 CSI_ADV_B
▥ VCCAUX	3 D01_DIN_0	28 DOUT_CSO_B
■ VCCINT	4 D02_0	29 D[04 to 15]
▤ VCCINT_IO	5 D03_0	30 EMCCLK
▥ VCCO_[bank number]	6 DONE_0	31 FOE_B
■ VCCBRAM	7 DXP	32 FWE_FCS2_B
▤ VCCADC	8 DXN	33 I2C_SCLK
▥ GNDADC	9 INIT_B_0	34 I2C_SDA
□ NC	10 M0_0	35 PERSTN[0 to 1]
▤ MGTAVCC_[R or L]	11 M1_0	36 RSO
▥ MGTAVTT_[R or L]	12 M2_0	37 RS1
▤ MGTVCCAUX_[R or L]	13 POR_OVERRIDE	
	14 PROGRAM_B_0	
	15 PUDC_B_0	
	16 RDWR_FCS_B_0	
	17 TCK_0	
	18 TDI_0	
	19 TDO_0	
	20 TMS_0	
	21 VP	
	22 VN	
	23 VREFF	
	24 VREFN	

ug575_c3_76_100815

Figure 3-76: FLGA2892 Package—XCVU440 Configuration/Power Diagram

FFVA676 (XCKU3P and XCKU5P)

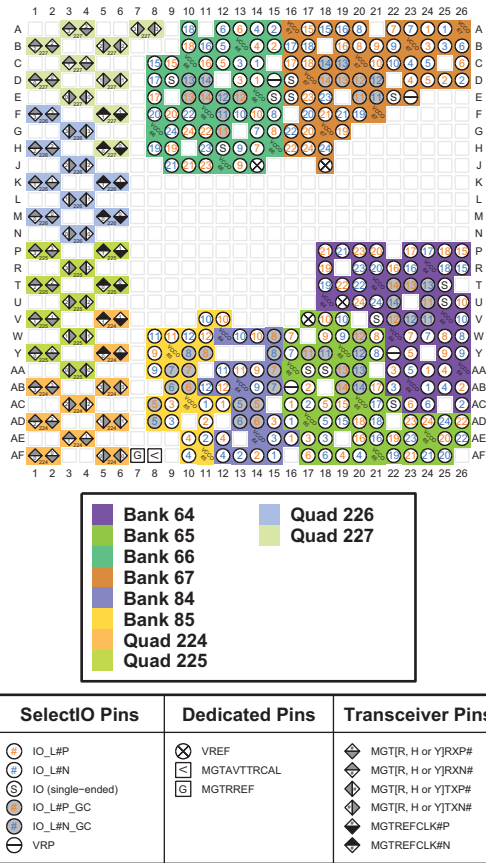

ug575_c3_100_030817

Figure 3-77: FFVA676 Package—XCKU3P and XCKU5P I/O Bank Diagram

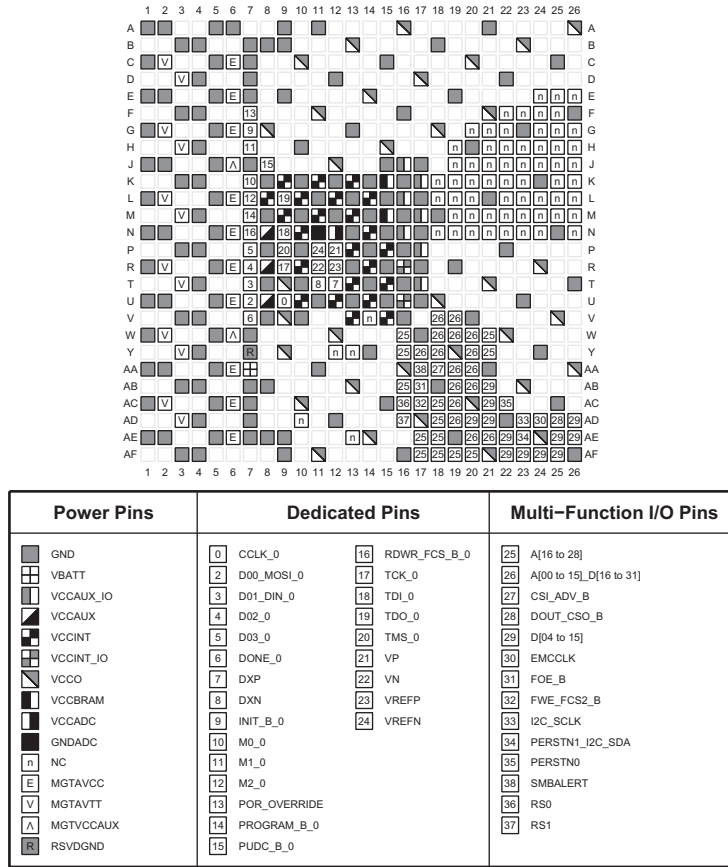

ug575_c3_100_030817

Figure 3-78: FFVA676 Package—XCKU3P and XCKU5P Configuration/Power Diagram

FFVB676 (XCKU3P and XCKU5P) and FFRB676 (XQKU5P)

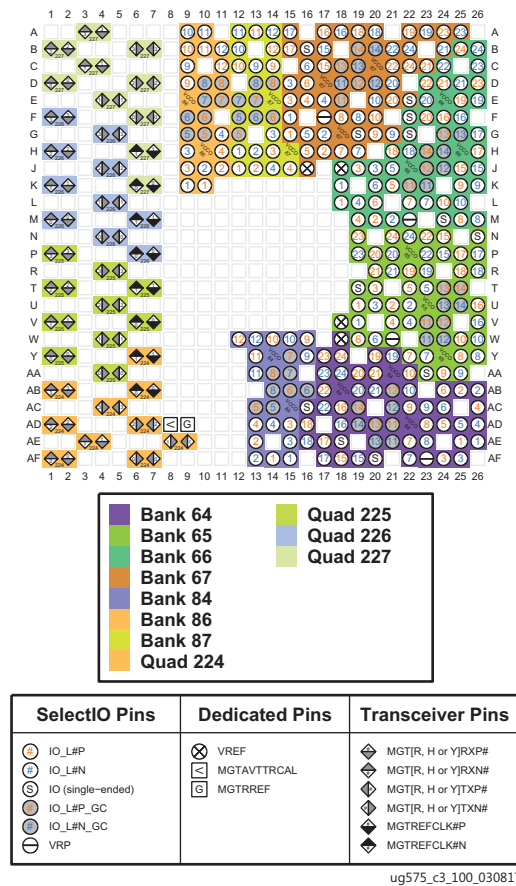

Figure 3-79: FFVB676 Package—XCKU3P and XCKU5P and FFRB676 Package—XQKU5P I/O Bank Diagram

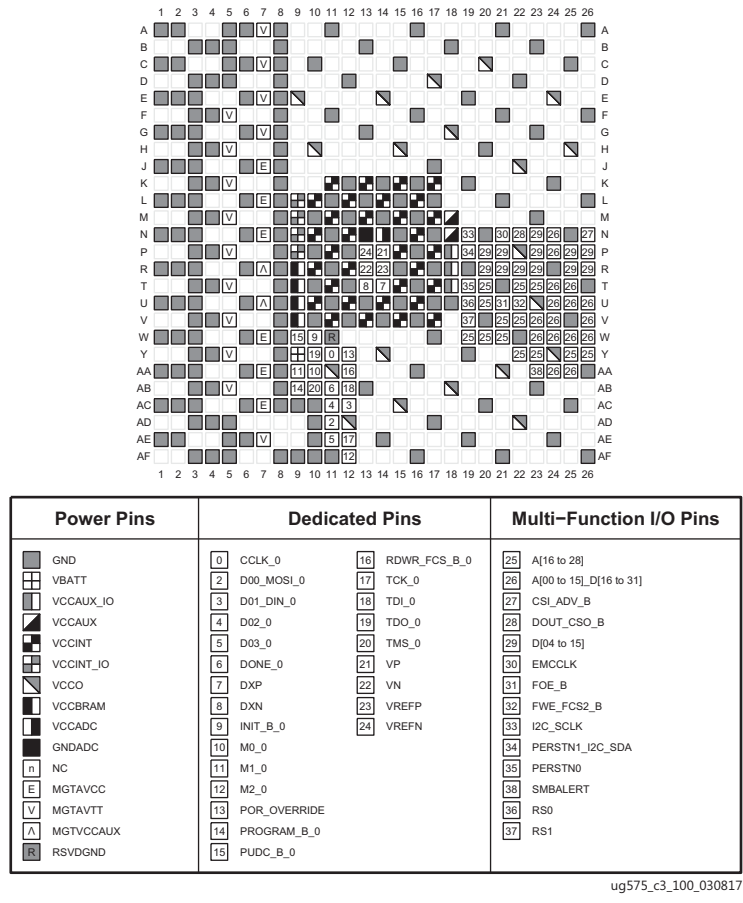

Figure 3-80: FFVB676 Package—XCKU3P and XCKU5P and FFRB676 Package—XQKU5P Configuration/Power Diagram

SFVB784 (XCKU3P and XCKU5P) and SFRB784 (XQKU5P)

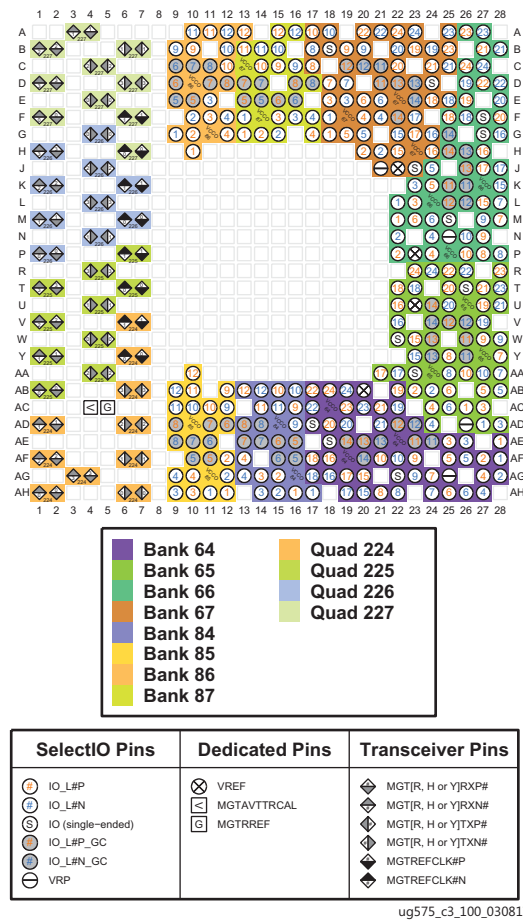

Figure 3-81: SFVB784 Package—XCKU3P and XCKU5P and SFRB784 Package—XQKU5P I/O Bank Diagram

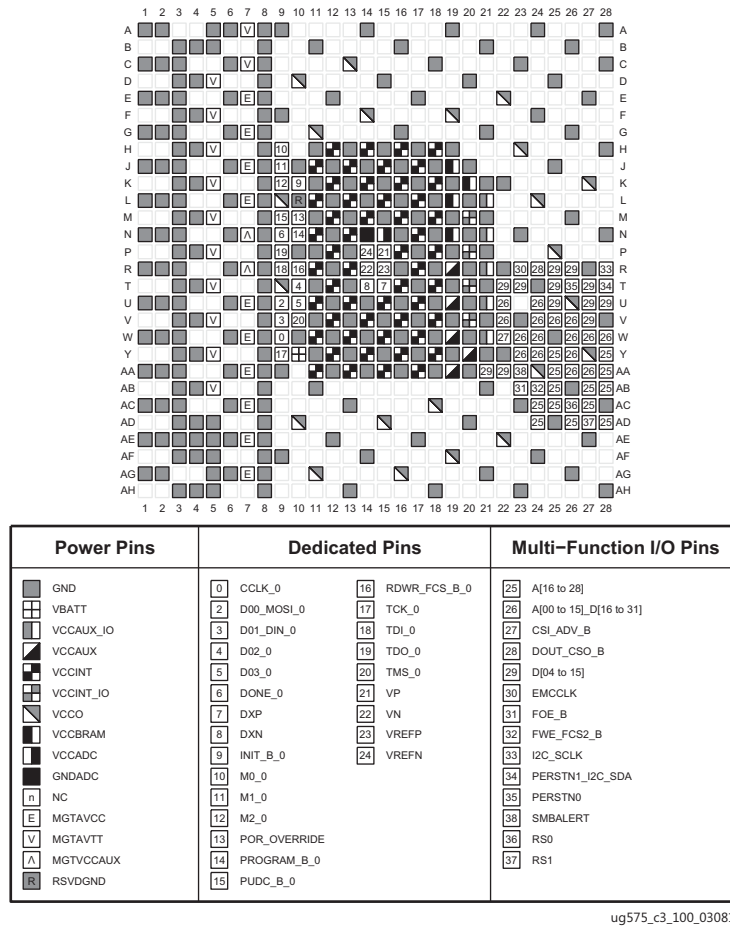
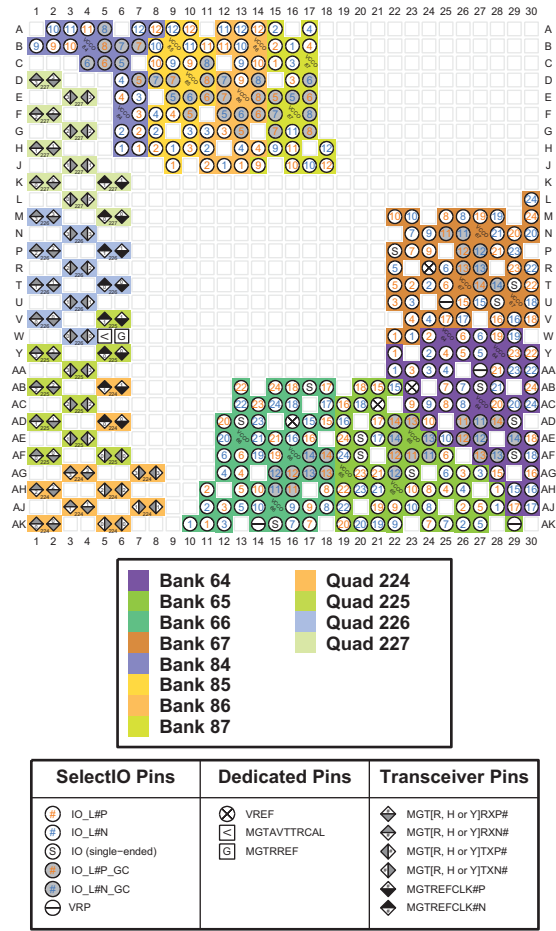

Figure 3-82: SFVB784 Package—XCKU3P and XCKU5P and SFRB784 Package—XQKU5P Configuration/Power Diagram

FFVD900 (XCKU3P and XCKU5P)



ug575_c3_100_030817

Figure 3-83: FFVD900 Package—XCKU3P and XCKU5P I/O Bank Diagram

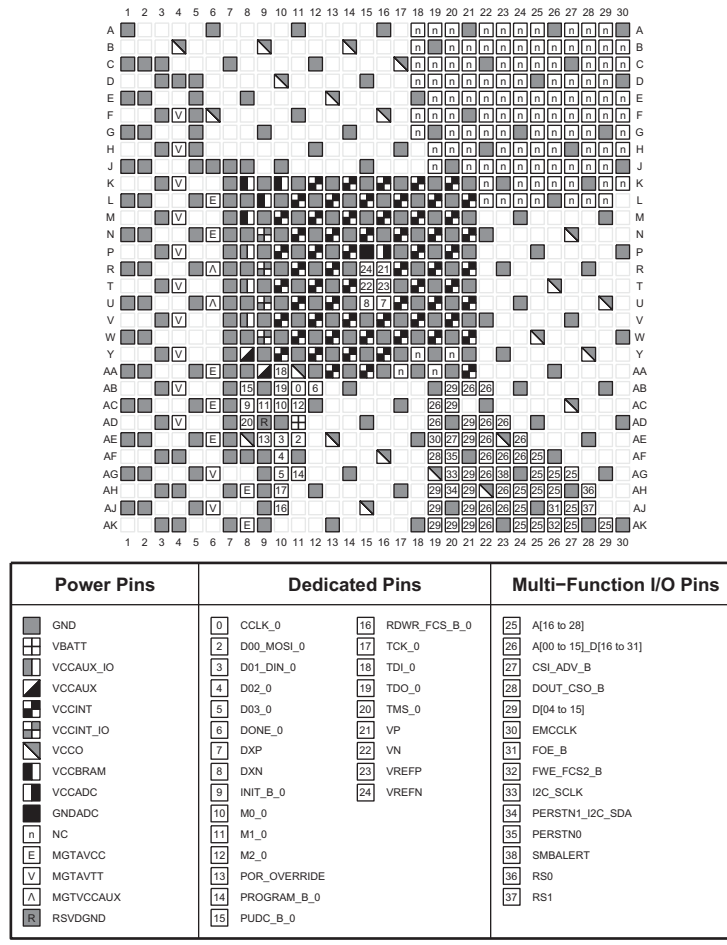

ug575_c3_100_030817

Figure 3-84: FFVD900 Package—XCKU3P and XCKU5P Configuration/Power Diagram

FFVD900 (XCKU11P)

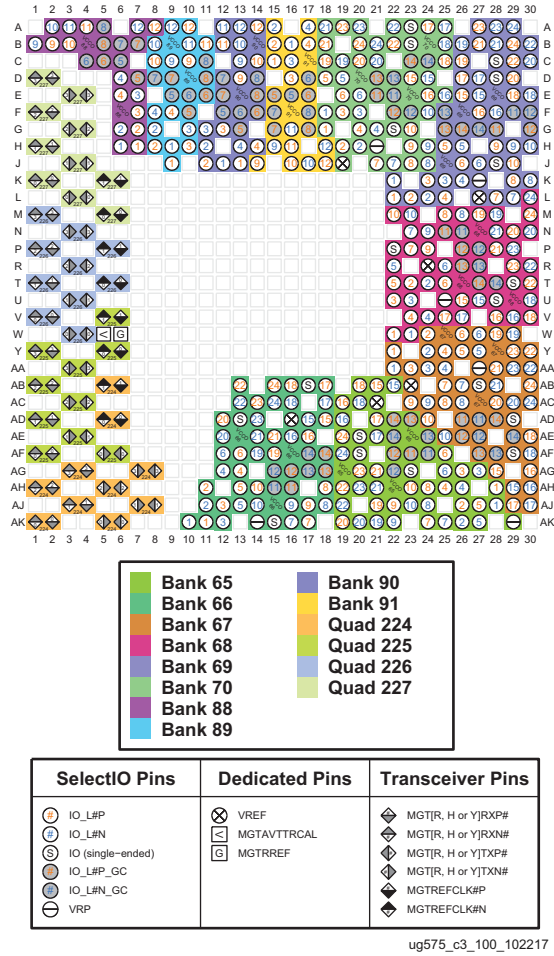

Figure 3-85: FFVD900 Package—XCKU11P I/O Bank Diagram

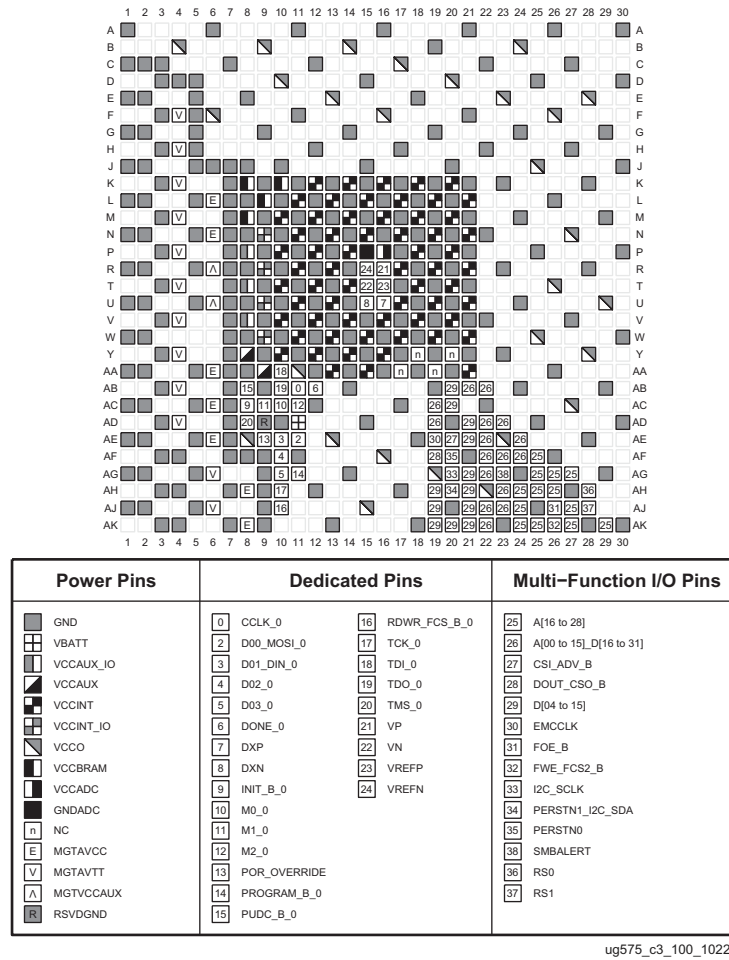
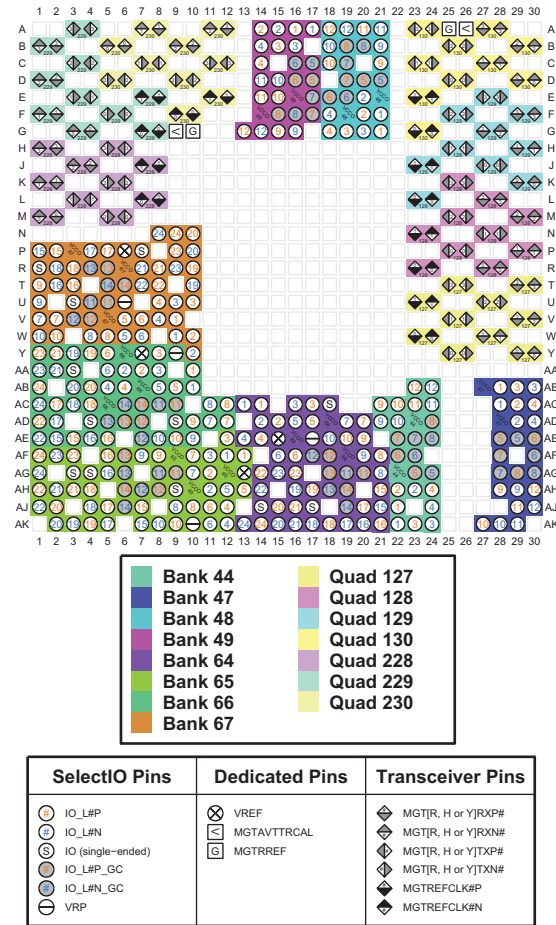

Figure 3-86: FFVD900 Package—XCKU11P Configuration/Power Diagram

FFVE900 (XCKU9P)



ug575_c3_100_030817

Figure 3-87: FFVE900 Package—XCKU9P I/O Bank Diagram

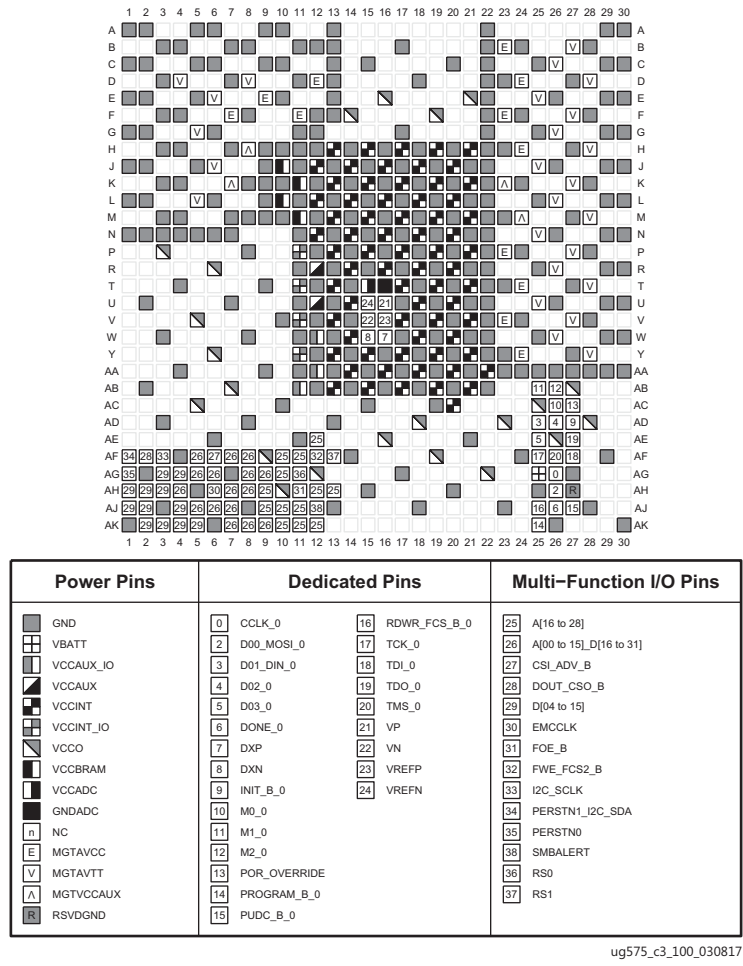
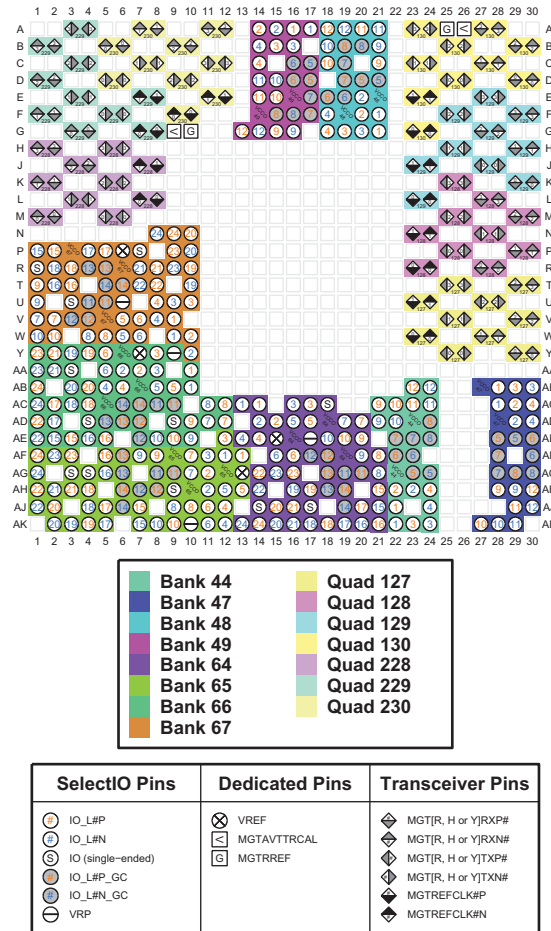

Figure 3-88: FFVE900 Package—XCKU9P Configuration/Power Diagram

FFVE900 (XCKU13P)



ug575_c3_100_030817

Figure 3-89: FFVE900 Package—XCKU13P I/O Bank Diagram

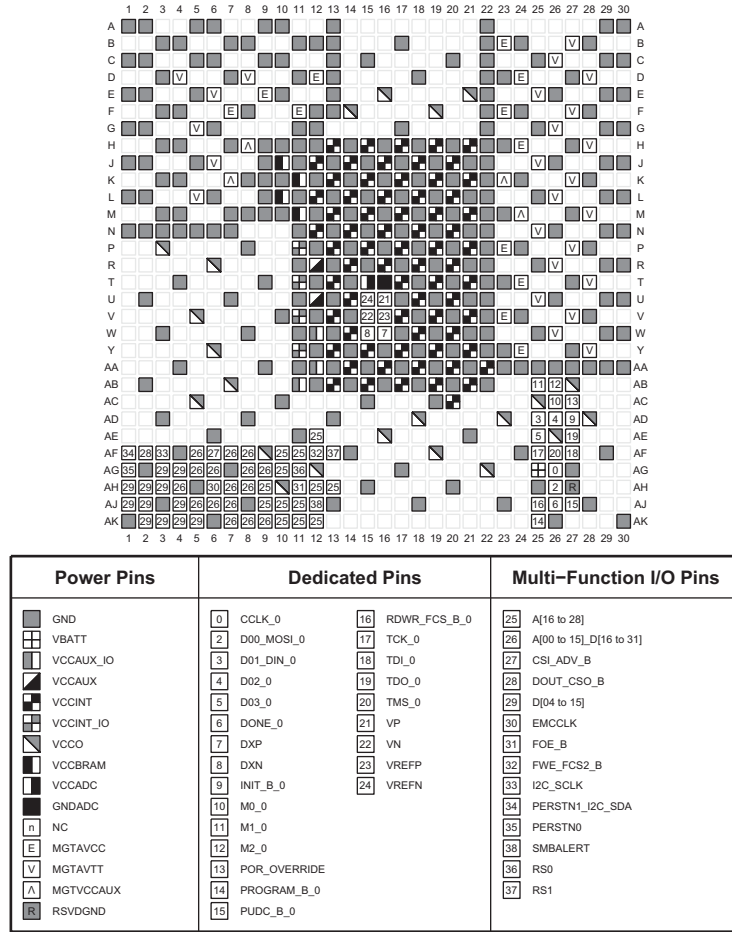

ug575_c3_100_030817

Figure 3-90: FFVE900 Package—XCKU13P Configuration/Power Diagram

FFVA1156 (XCKU11P)

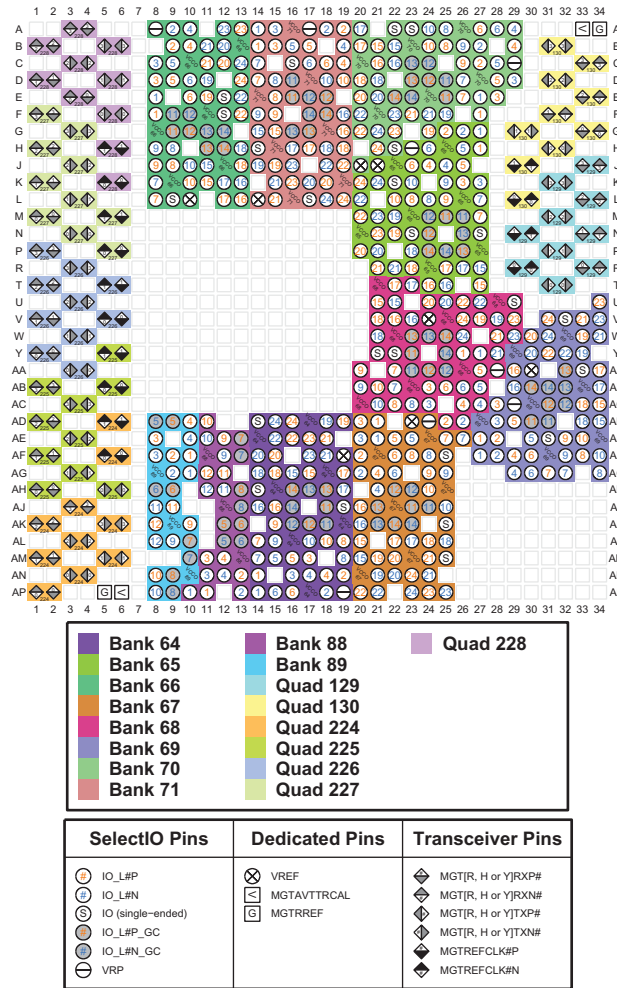

ug575_c3_100_062217

Figure 3-91: FFVA1156 Package—XCKU11P I/O Bank Diagram

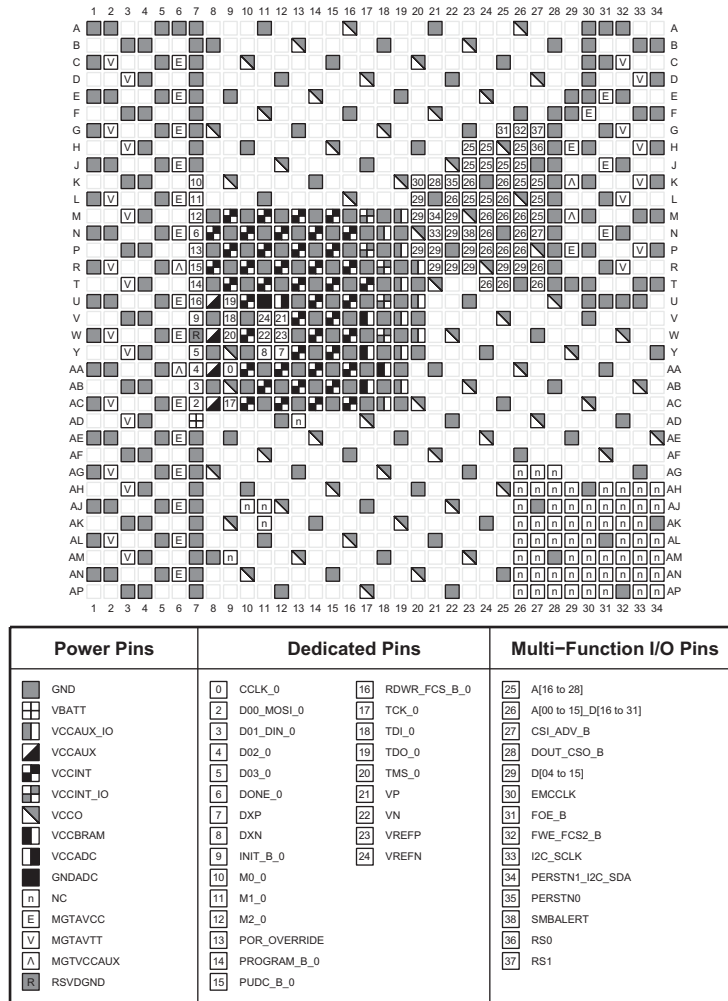

ug575_c3_100_062217

Figure 3-92: FFVA1156 Package—XCKU11P Configuration/Power Diagram

FFVA1156 (XCKU15P) and FFRA1156 (XQKU15P)

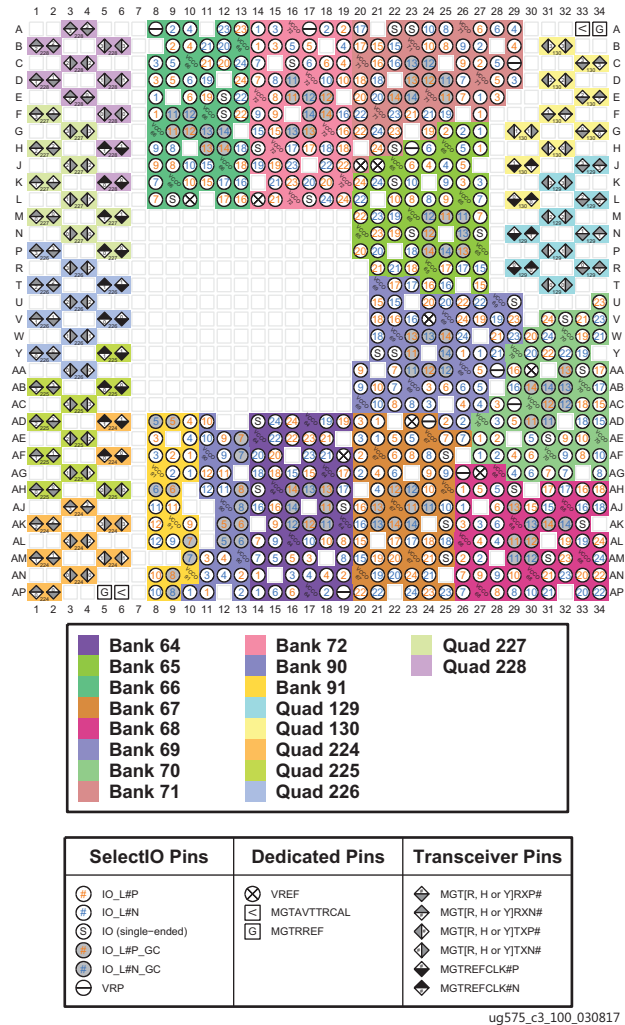
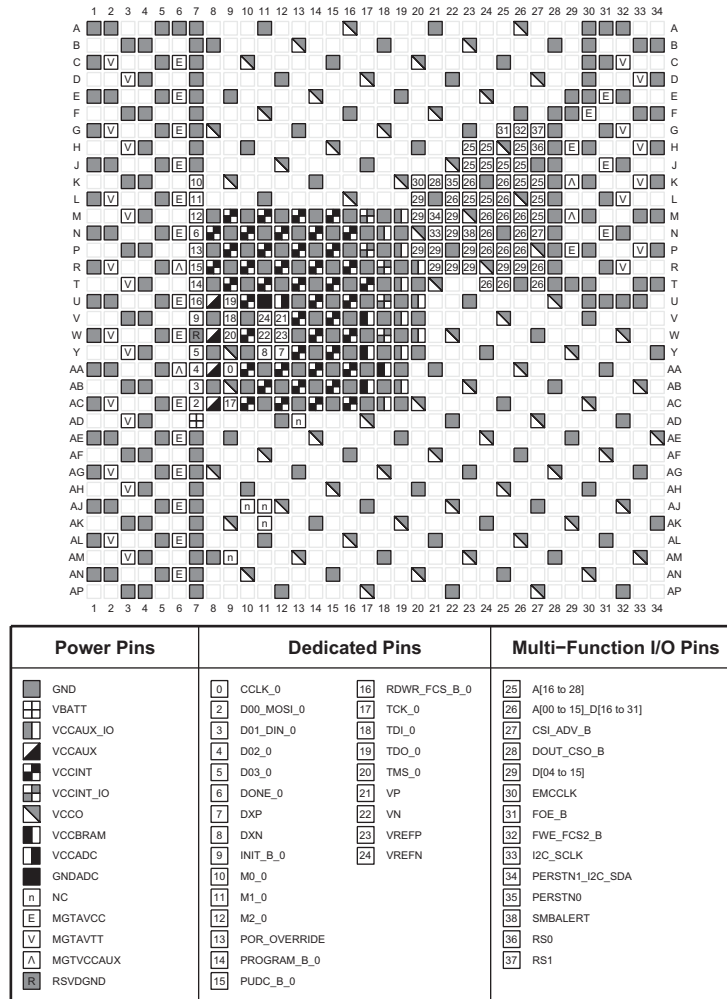

Figure 3-93: FFVA1156 Package—XCKU15P and FFRA1156 Package—XQKU15P I/O Bank Diagram



ug575_c3_100_030817

Figure 3-94: FFVA1156 Package—XCKU15P and FFRA1156 Package—XQKU15P Configuration/Power Diagram

FFVE1517 (XCKU11P)

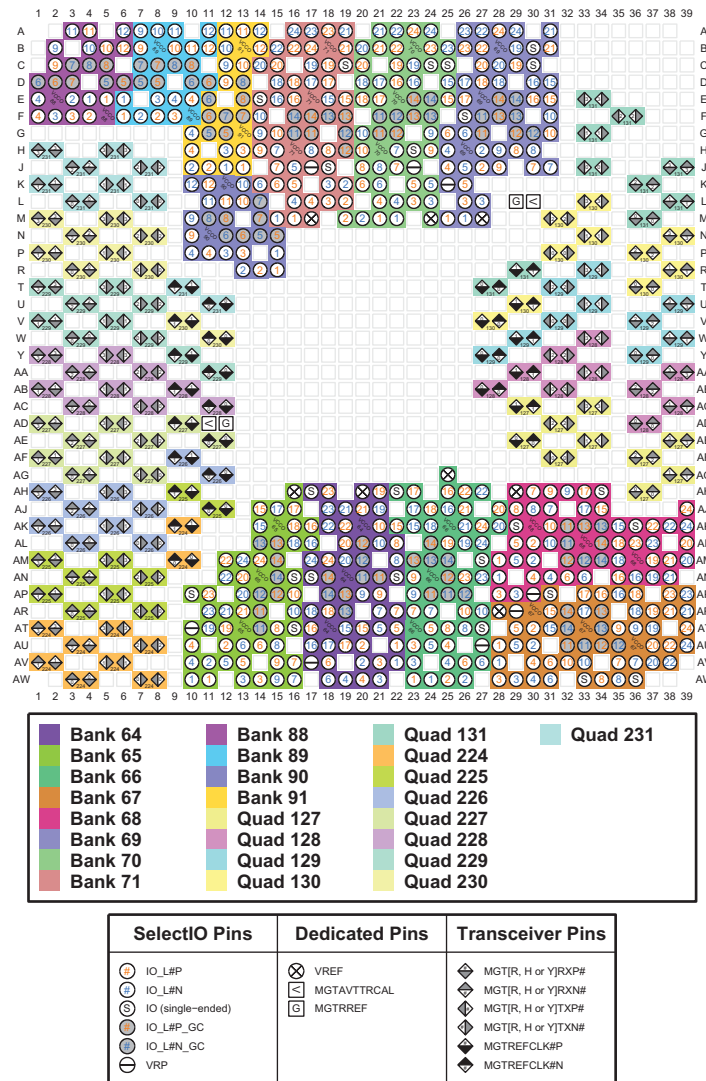

ug575_c3_100_062217

Figure 3-95: FFVE1517 Package—XCKU11P I/O Bank Diagram

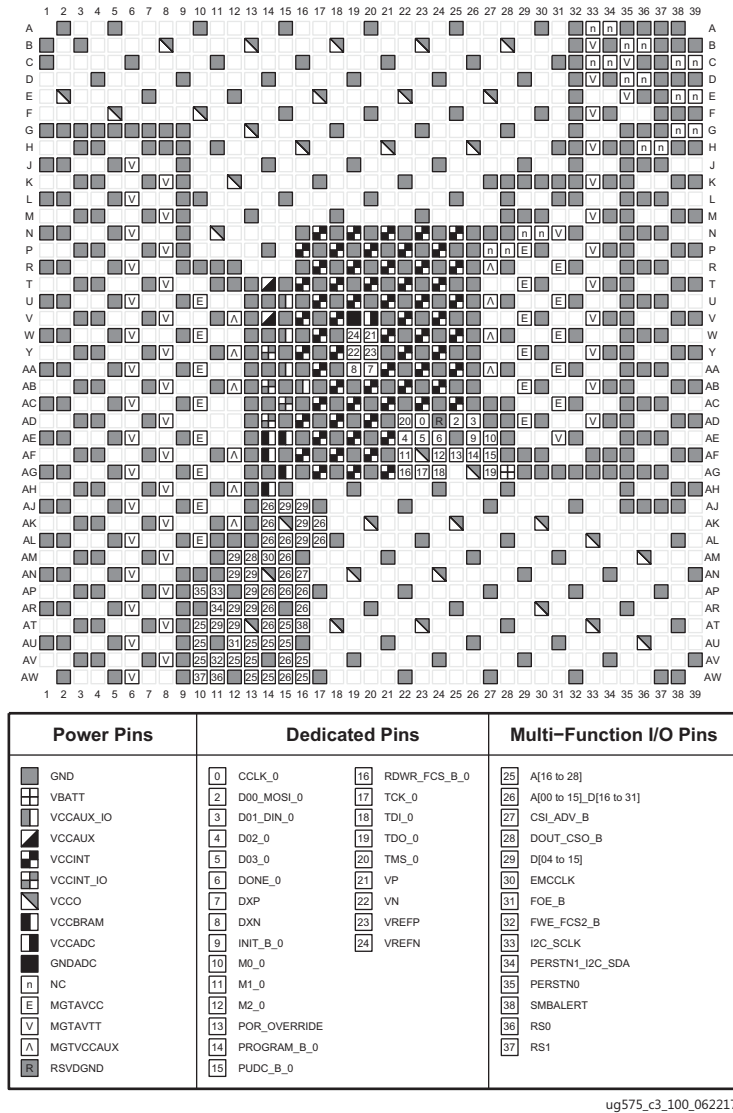
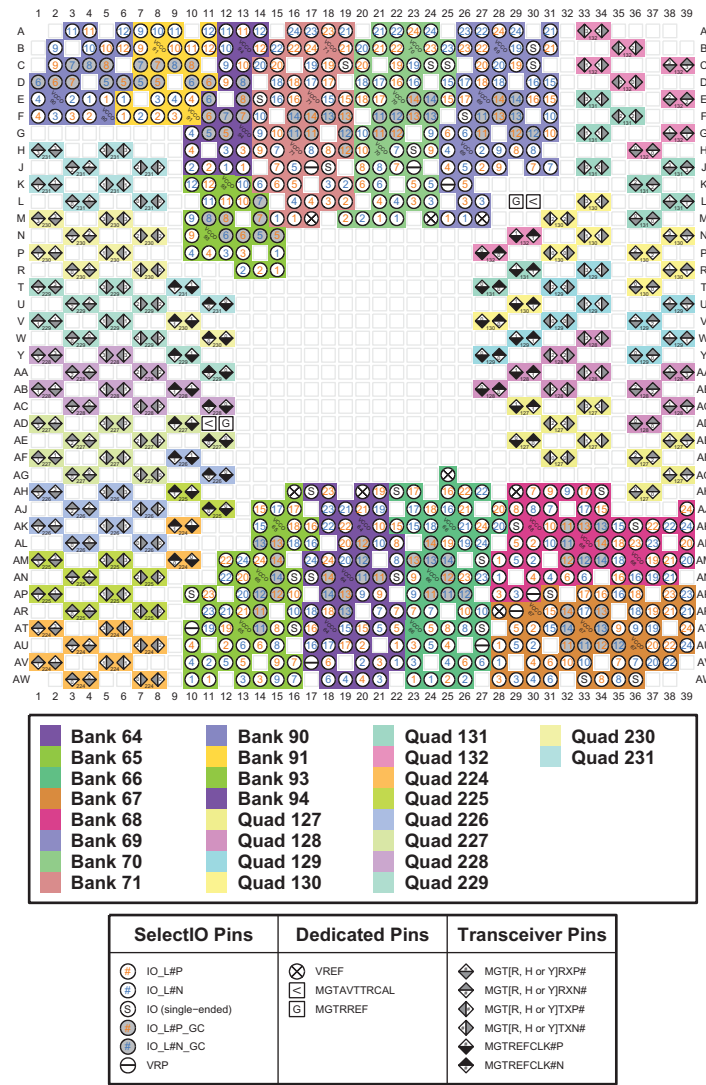

Figure 3-96: FFVE1517 Package—XCKU11P Configuration/Power Diagram

FFVE1517 (XCKU15P) and FFRE1517 (XQKU15P)



ug575_c3_100_030817

Figure 3-97: FFVE1517 Package—XCKU15P and FFRE1517 Package—XQKU15P I/O Bank Diagram

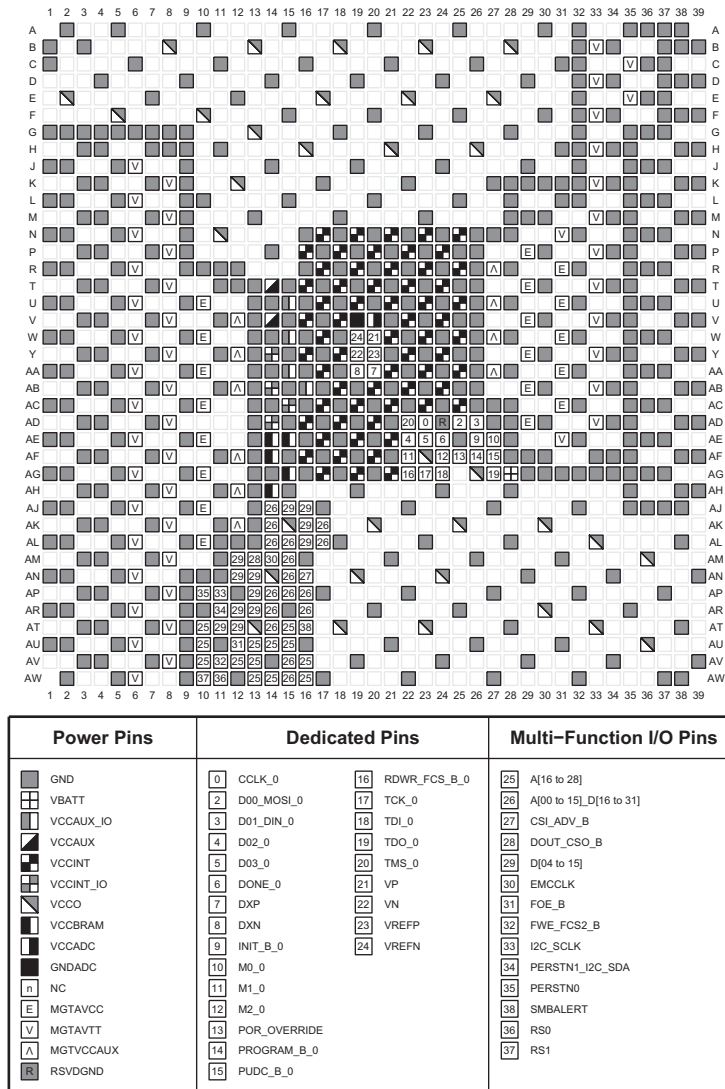

ug575_c3_100_030817

Figure 3-98: FFVE1517 Package—XCKU15P and FFRE1517 Package—XQKU15P Configuration/Power Diagram

FFVA1760 (XCKU15P)

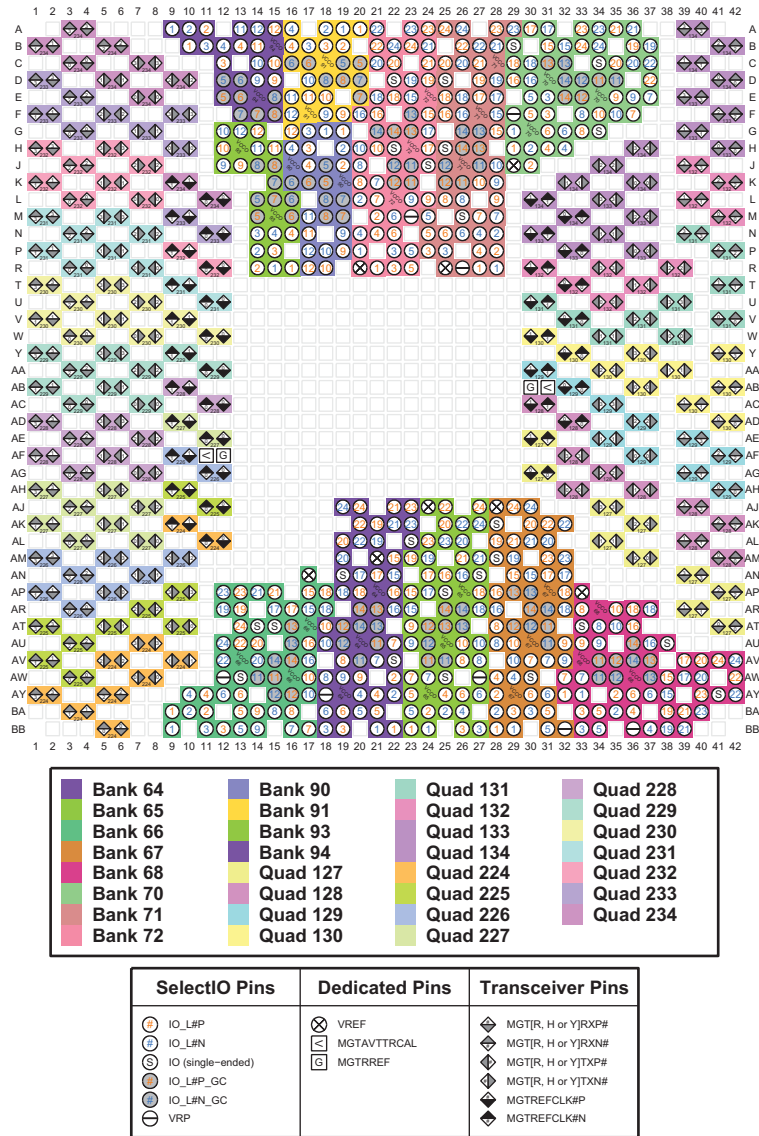

ug575_c3_100_030817

Figure 3-99: FFVA1760 Package—XCKU15P I/O Bank Diagram

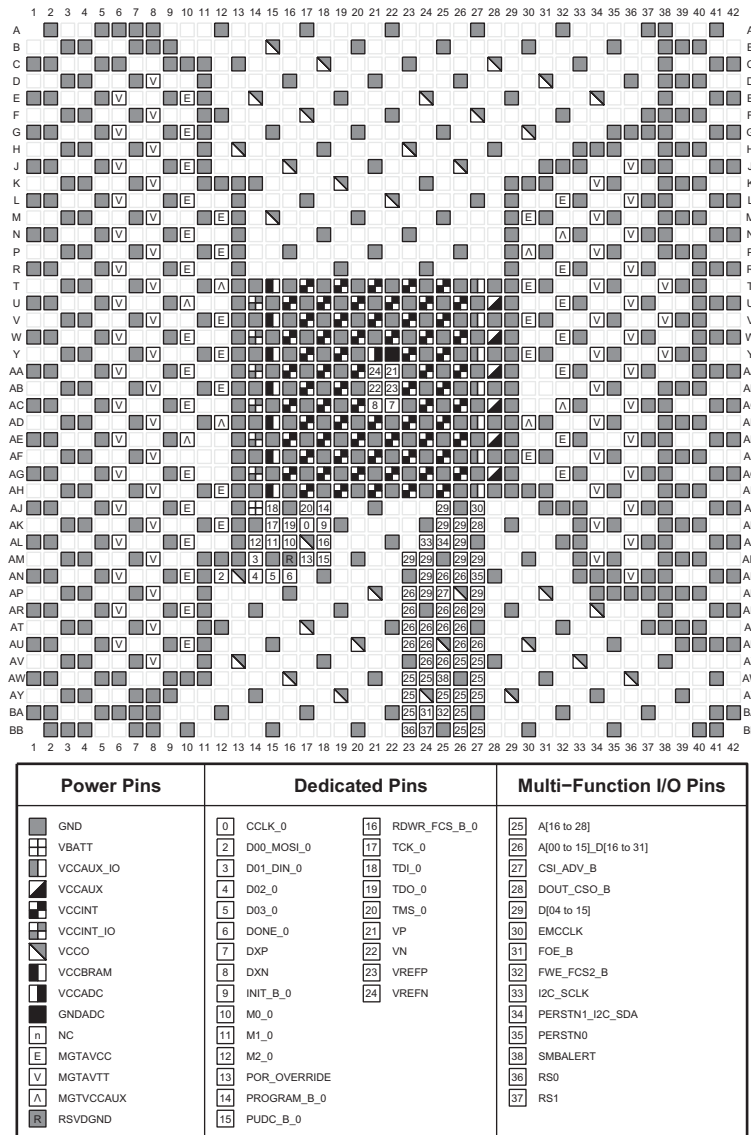

ug575_c3_100_030817

Figure 3-100: FFVA1760 Package—XCKU15P Configuration/Power Diagram

FFVE1760 (XCKU15P)

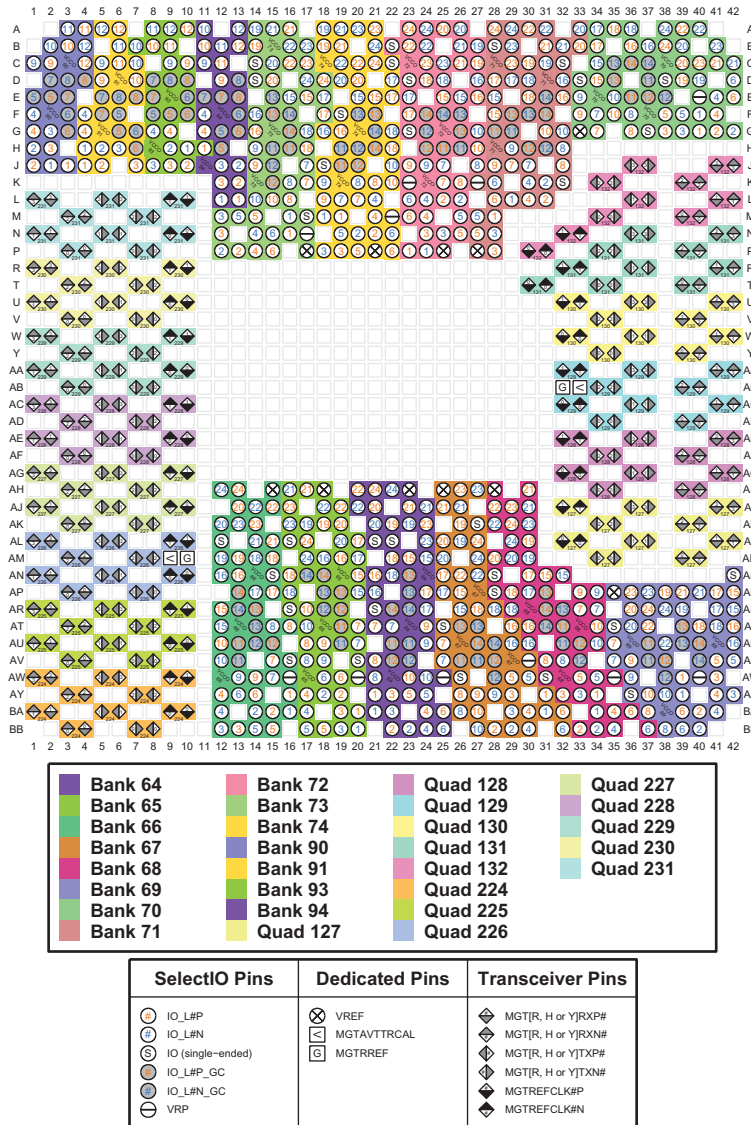

ug575_c3_100_030817

Figure 3-101: FFVE1760 Package—XCKU15P I/O Bank Diagram

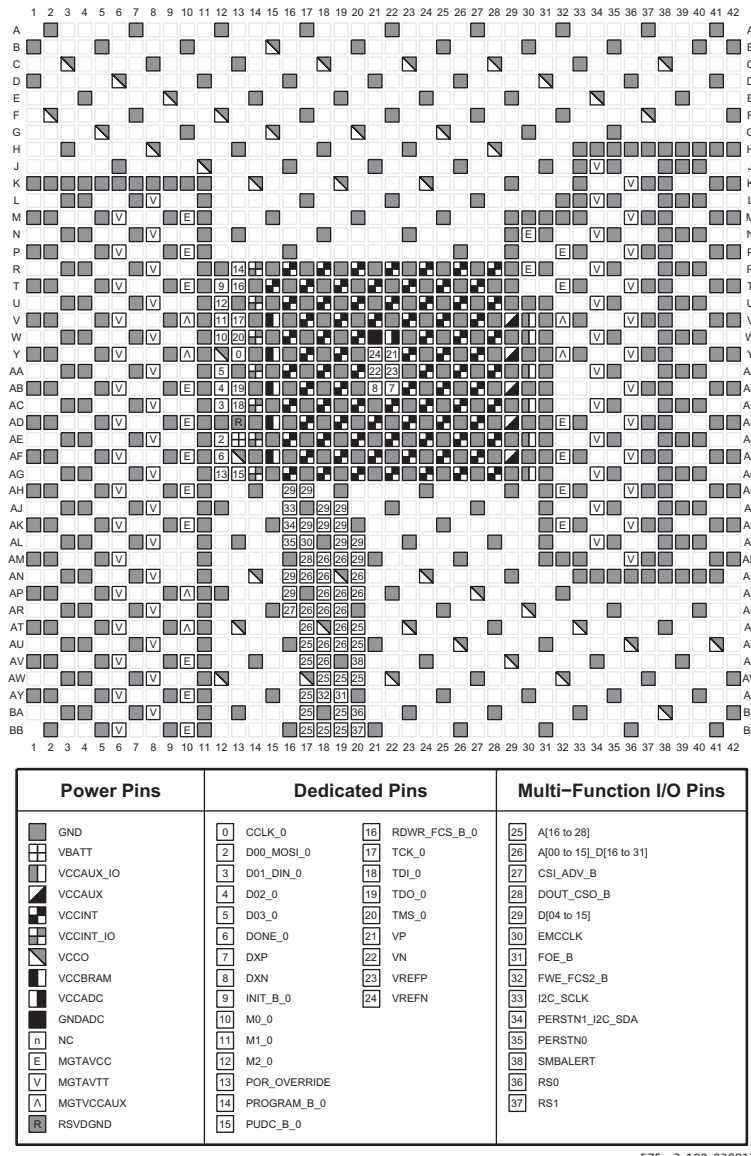

ug575_c3_100_030817

Figure 3-102: FFVE1760 Package—XCKU15P Configuration/Power Diagram

FFVC1517 (XCVU3P) and FFRC1517 (XQVU3P)

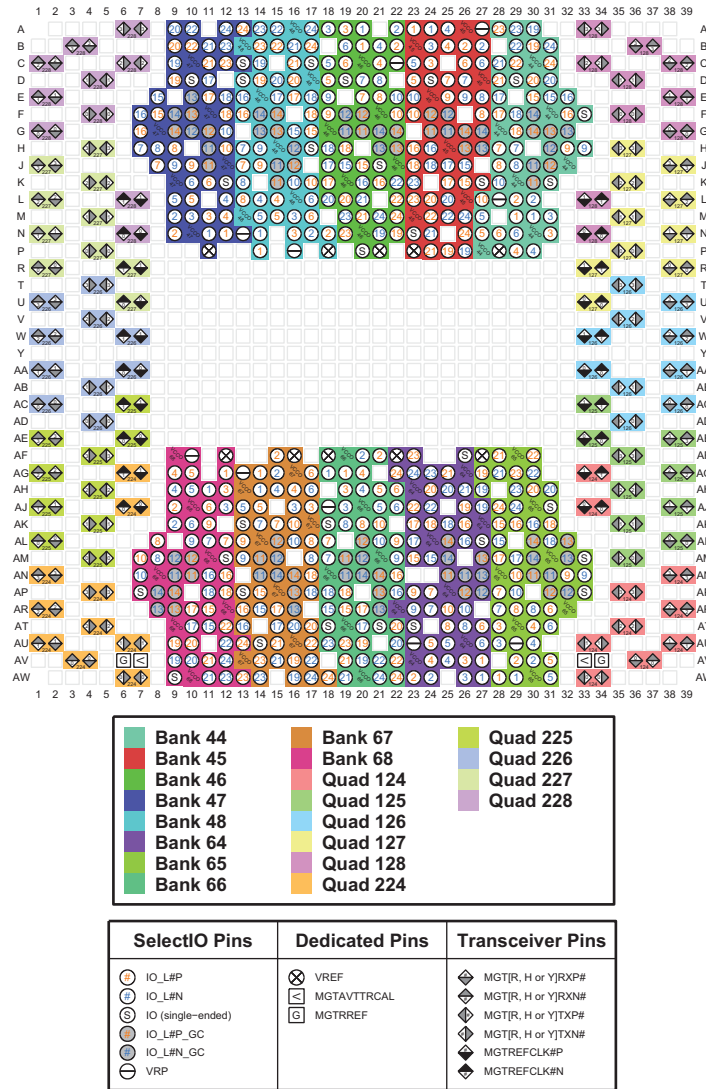

ug575_c3_100_030817

Figure 3-103: FFVC1517 Package—XCVU3P and FFRC1517 Package—XQVU3P I/O Bank Diagram

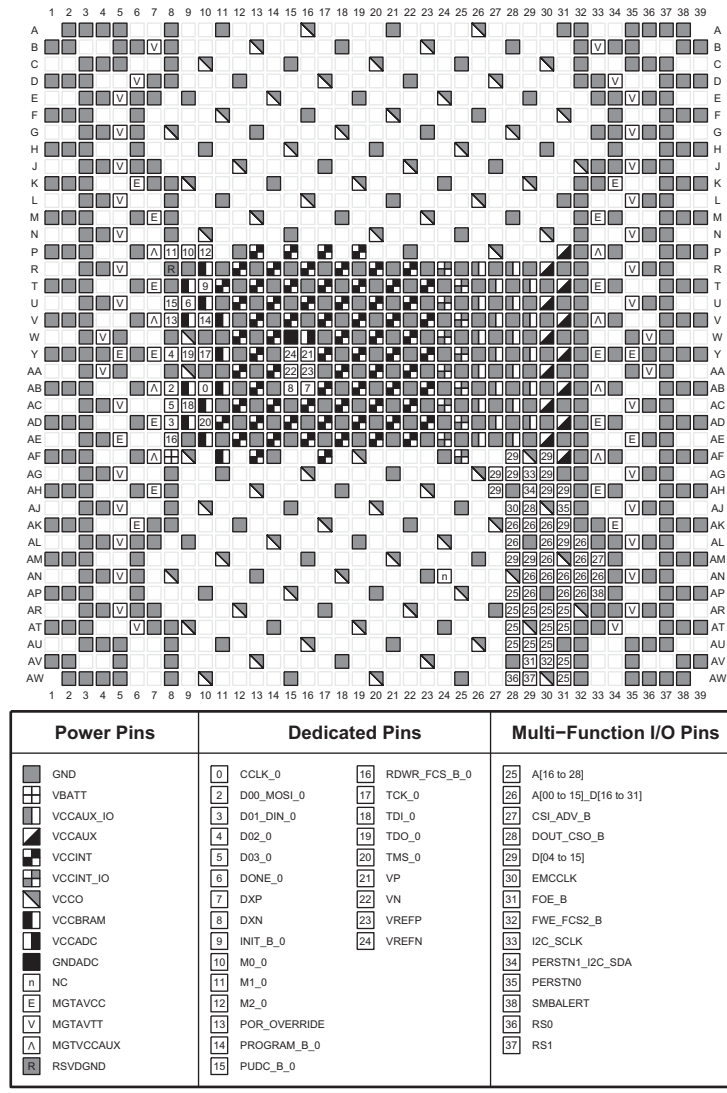
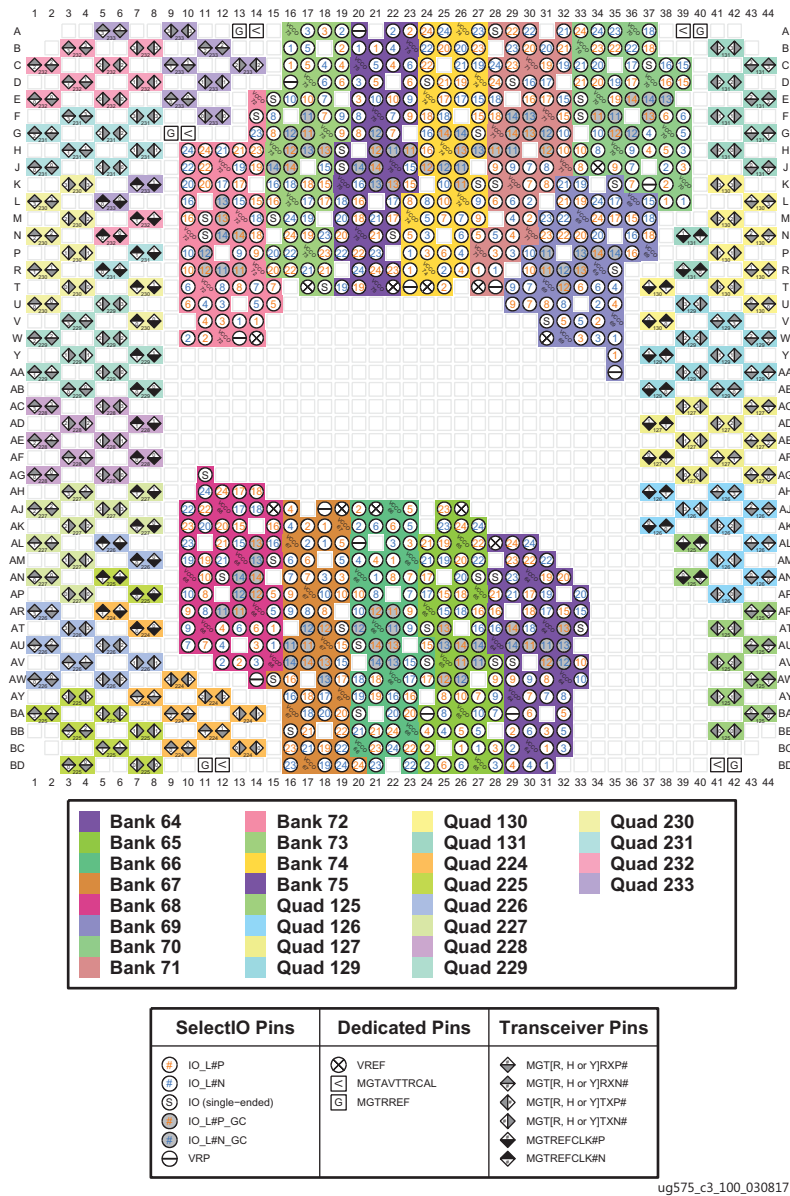

Figure 3-104: FFVC1517 Package—XCVU3P and FFRC1517 Package—XQVU3P Configuration/Power Diagram

FLGF1924 (XCVU11P)



ug575_c3_100_030817

Figure 3-105: FLGF1924 Package—XCVU11P I/O Bank Diagram

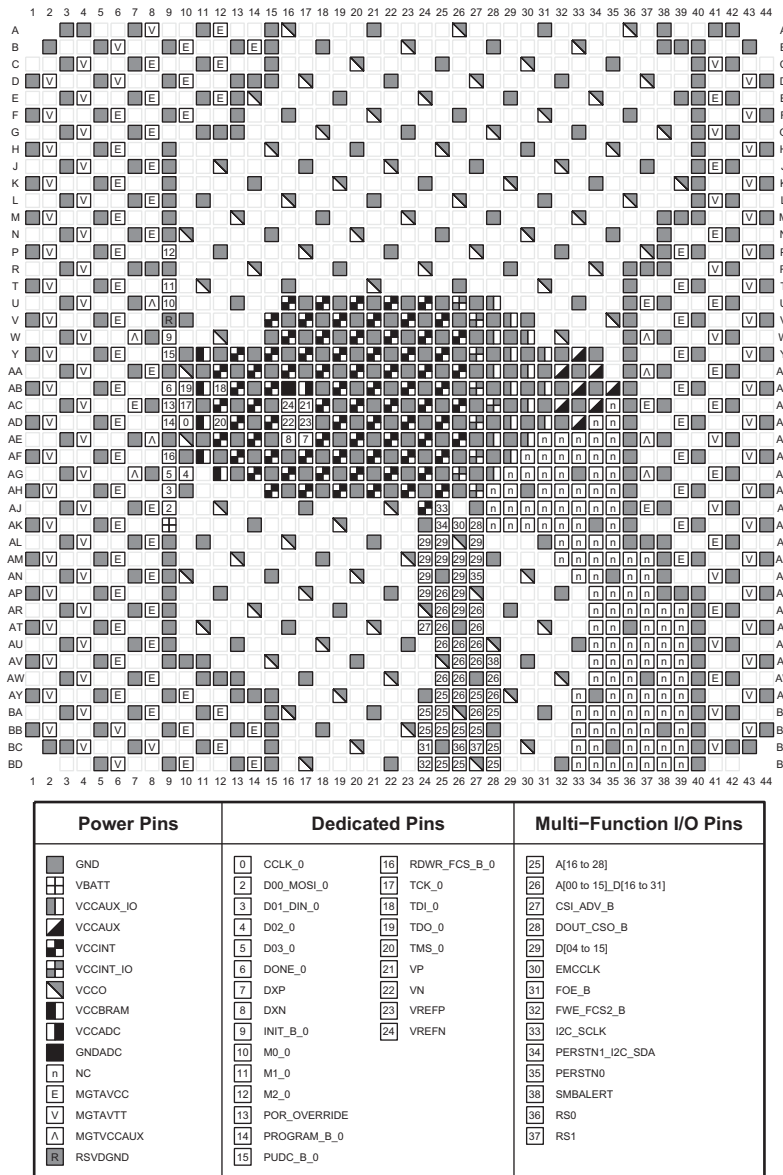

ug575_c3_100_030817

Figure 3-106: FLGF1924 Package—XCVU11P Configuration/Power Diagram

FSVH1924 (XCVU31P)

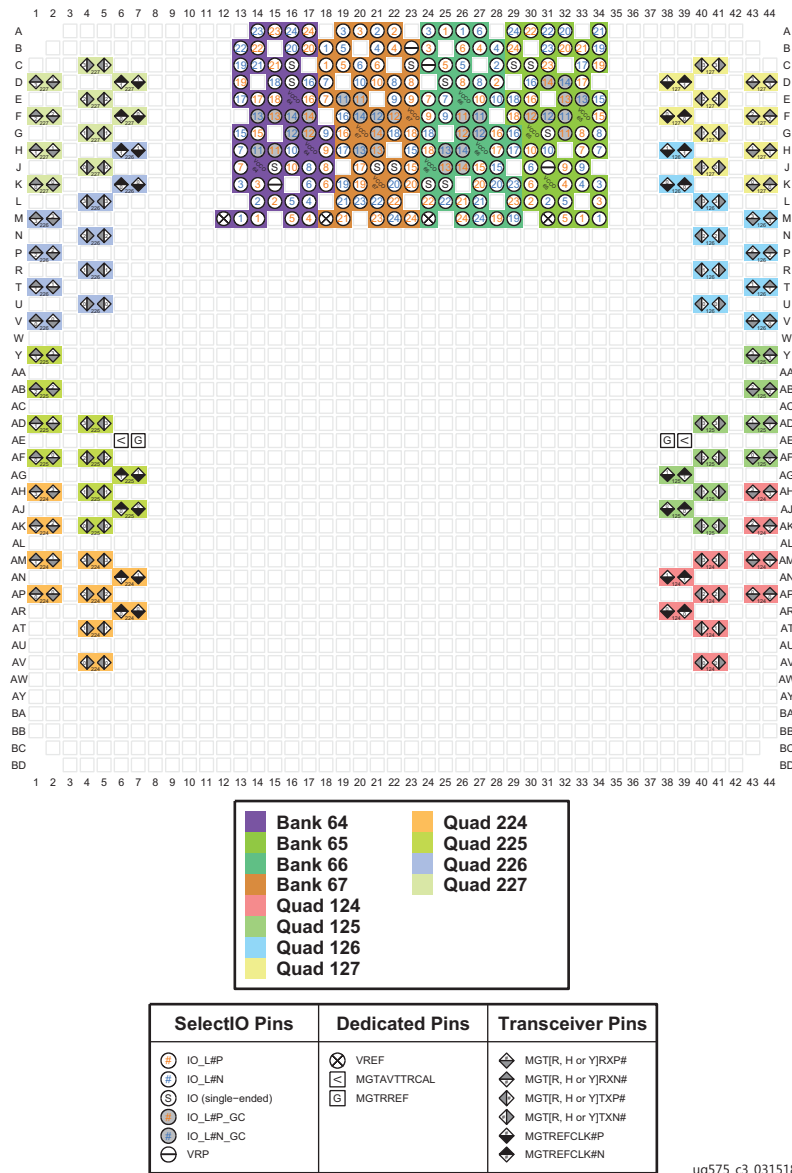
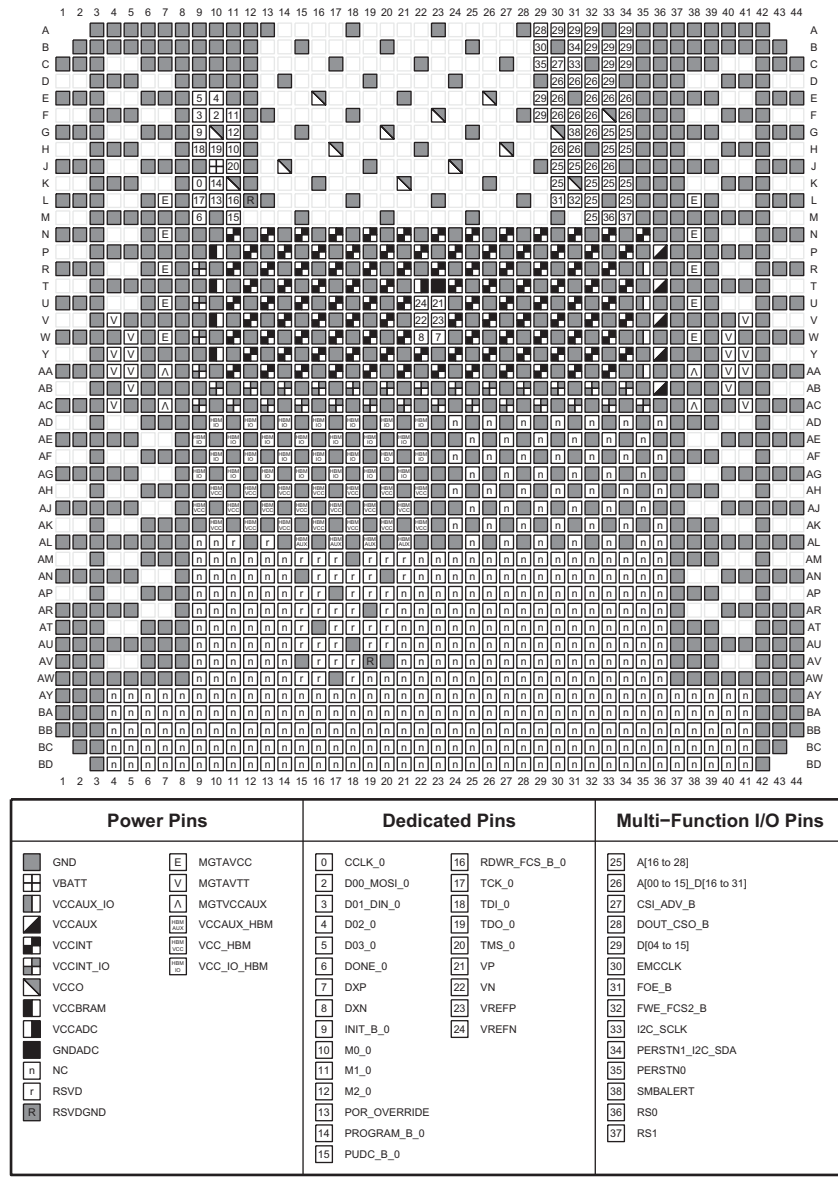

Figure 3-107: FSVH1924 Package—XCVU31P I/O Bank Diagram



ug575_c3_031518

Figure 3-108: FSVH1924 Package—XCVU31P Configuration/Power Diagram

FLVA2104 (XCVU5P and XCVU7P) and FLRA2104 (XQVU7P)

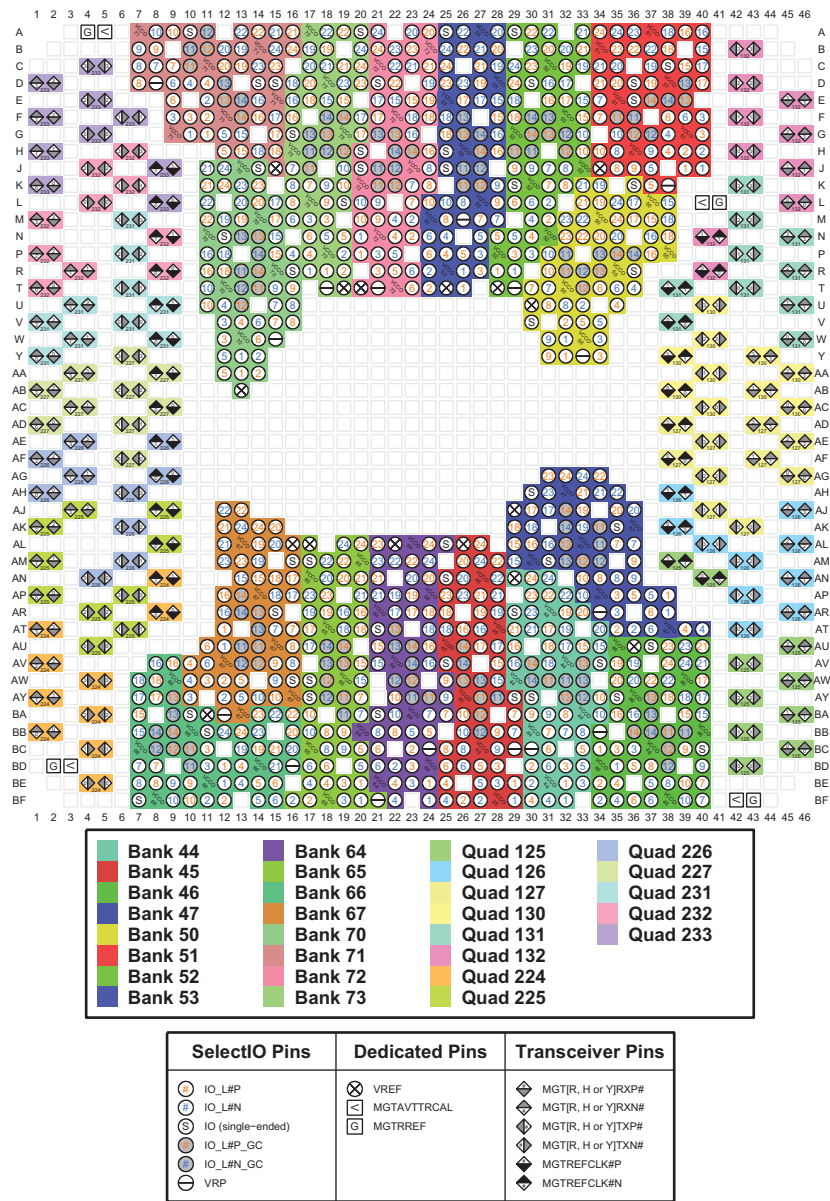

ug575_c3_100_030817

Figure 3-109: FLVA2104 Package—XCVU5P and XCVU7P and FLRA2104 Package—XQVU7P I/O Bank Diagram

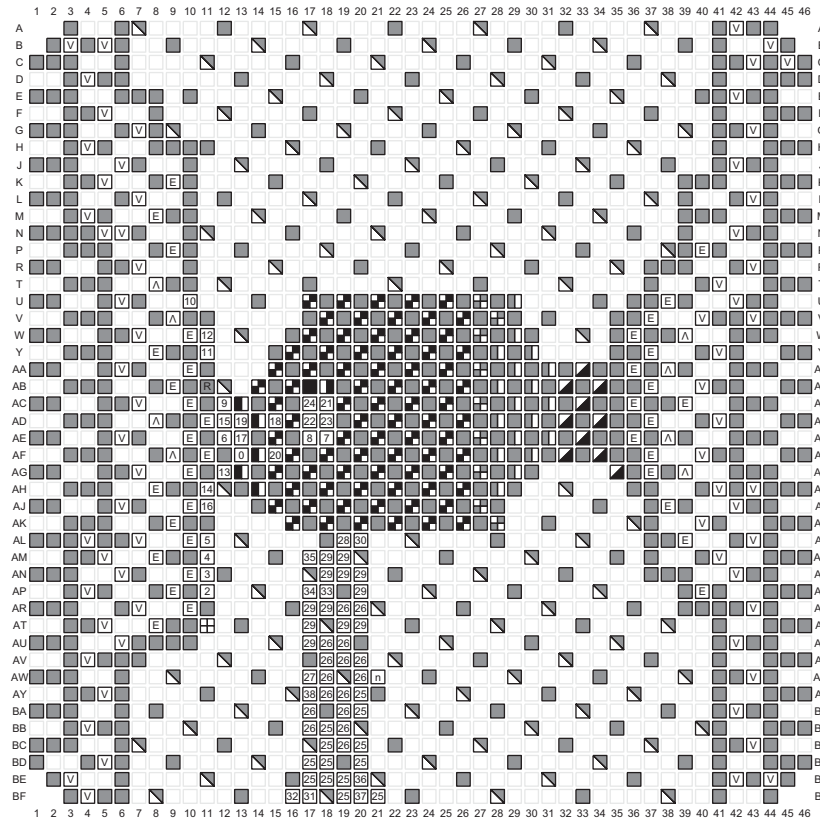

Power Pins	Dedicated Pins	Multi-Function I/O Pins
GND	0 CCLK_0	25 A[16 to 28]
VBATT	2 D00_MOSI_0	26 A[00 to 15]_D[16 to 31]
VCCAUX_IO	3 D01_DIN_0	27 CSI_ADV_B
VCCAUX	4 D02_0	28 DOUT_CSO_B
VCCINT	5 D03_0	29 D[04 to 15]
VCCINT_IO	6 DONE_0	30 EMCCLK
VCCO	7 DXP	31 FOE_B
VCCBRAM	8 DXN	32 FWE_FCS2_B
VCCADC	9 INIT_B_0	33 I2C_SCLCK
GNDADC	10 M0_0	34 PERSTN1_I2C_SDA
NC	11 M1_0	35 PERSTN0
MGTAVCC	12 M2_0	38 SMBALERT
MGTAVTT	13 POR_OVERRIDE	36 RS0
MGTVCCAUX	14 PROGRAM_B_0	37 RS1
RSVDGND	15 PUDC_B_0	
	16 RDWR_FCS_B_0	
	17 TCK_0	
	18 TDL_0	
	19 TDO_0	
	20 TMS_0	
	21 VP	
	22 VN	
	23 VREFP	
	24 VREFN	

ug575_c3_100_030817

Figure 3-110: FLVA2104 Package—XCVU5P and XCVU7P and FLRA2104 Package—XQVU7P Configuration/Power Diagram

FLGA2104 (XCVU9P)

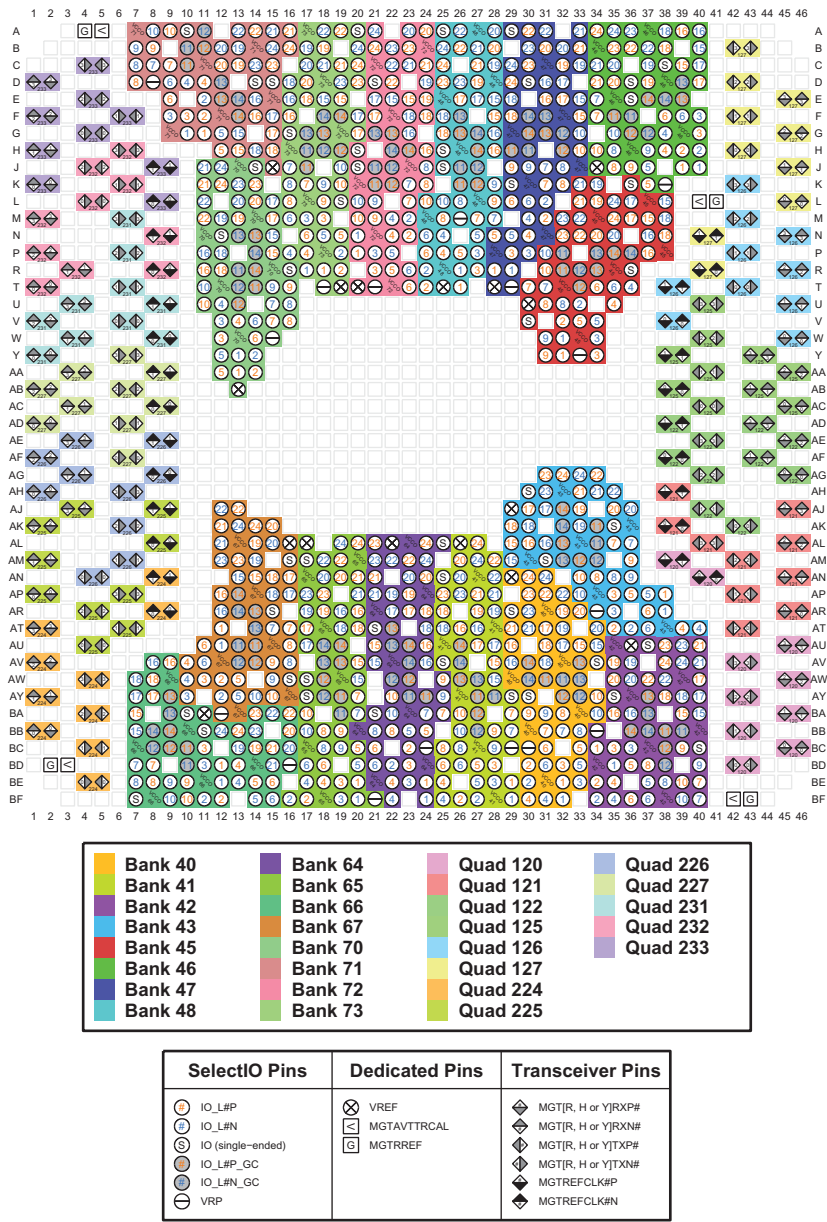
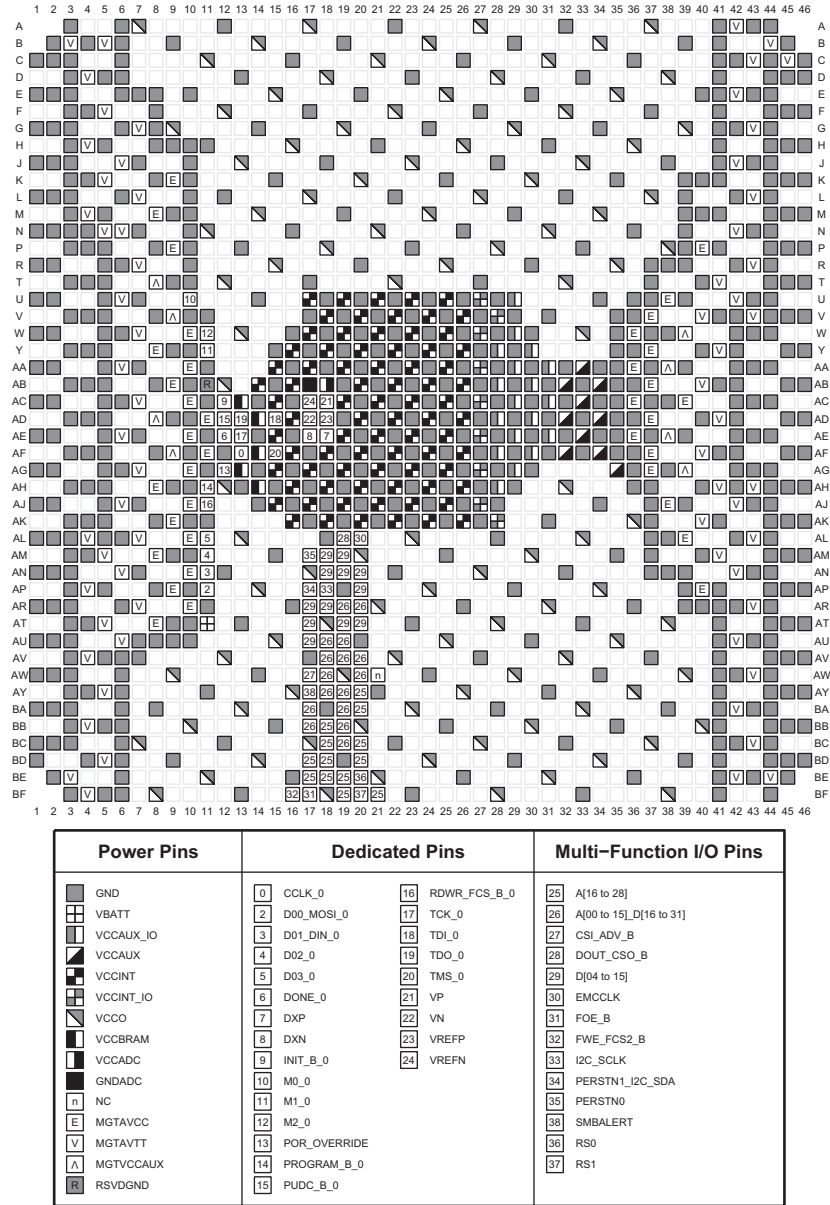

Figure 3-111: FLGA2104 Package—XCVU9P I/O Bank Diagram



ug575_c3_100_030817

Figure 3-112: FLGA2104 Package—XCVU9P Configuration/Power Diagram

FHGA2104 (XCVU13P)

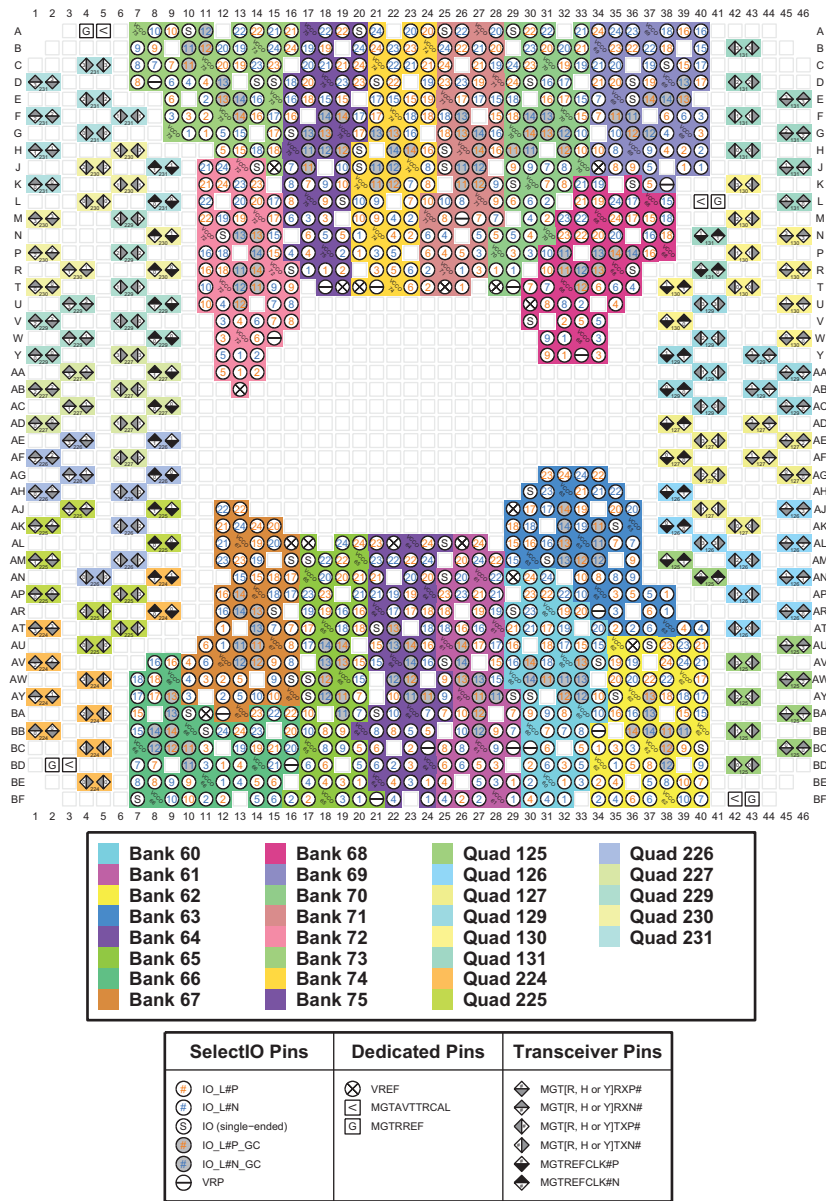

ug575_c3_100_062217

Figure 3-113: FHGA2104 Package—XCVU13P I/O Bank Diagram

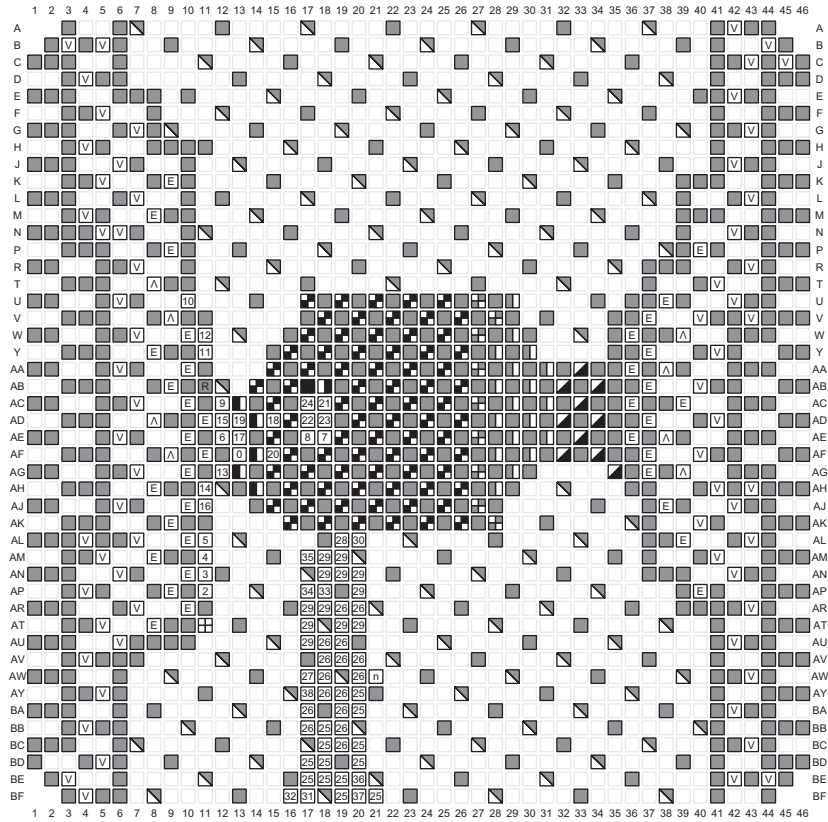

Power Pins	Dedicated Pins		Multi-Function I/O Pins
GND	0 CCLK_0	16 RDWR_FCS_B_0	25 A[16 to 28]
VBATT	2 D00_MOSI_0	17 TCK_0	26 A[00 to 15]_D[16 to 31]
VCCAUX_IO	3 D01_DIN_0	18 TDI_0	27 CSI_ADV_B
VCCAUX	4 D02_0	19 TDO_0	28 DOUT_CSO_B
VCCINT	5 D03_0	20 TMS_0	29 D[04 to 15]
VCCINT_IO	6 DONE_0	21 VP	30 EMCCLK
VCCO	7 DXP	22 VN	31 FOE_B
VCCBRAM	8 DXN	23 VREFP	32 FWE_FCS2_B
VCCADC	9 INIT_B_0	24 VREFN	33 I2C_SCLK
GNDADC	10 M0_0		34 PERSTN1_I2C_SDA
n NC	11 M1_0		35 PERSTN0
E MGTAVCC	12 M2_0		38 SMBALERT
V MGTAVTT	13 POR_OVERRIDE		36 RSO
A MGTVCCAUX	14 PROGRAM_B_0		37 RS1
R RSVGDND	15 PUDC_B_0		

ug575_c3_100_062217

Figure 3-114: FHGA2104 Package—XCVU13P Configuration/Power Diagram

FLVB2104 (XCVU5P and XCVU7P) and FLRB2104 (XQVU7P)

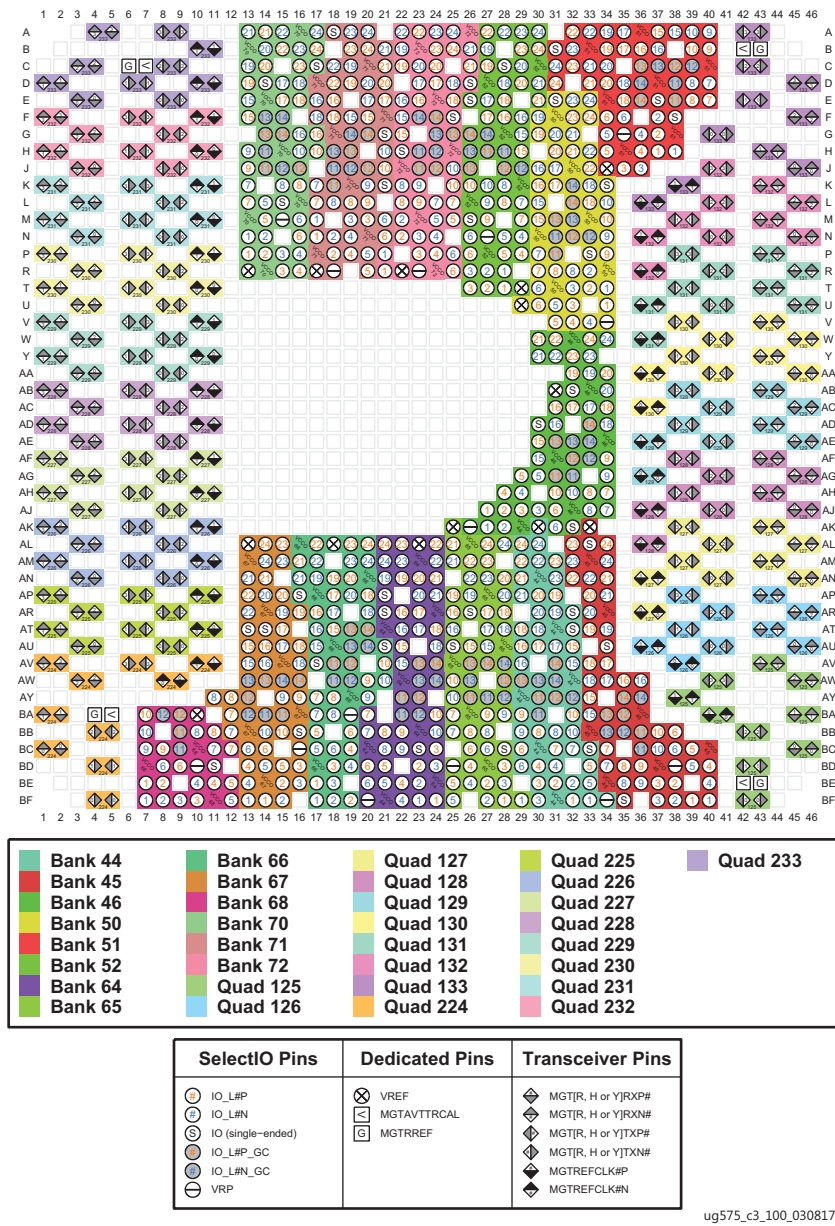
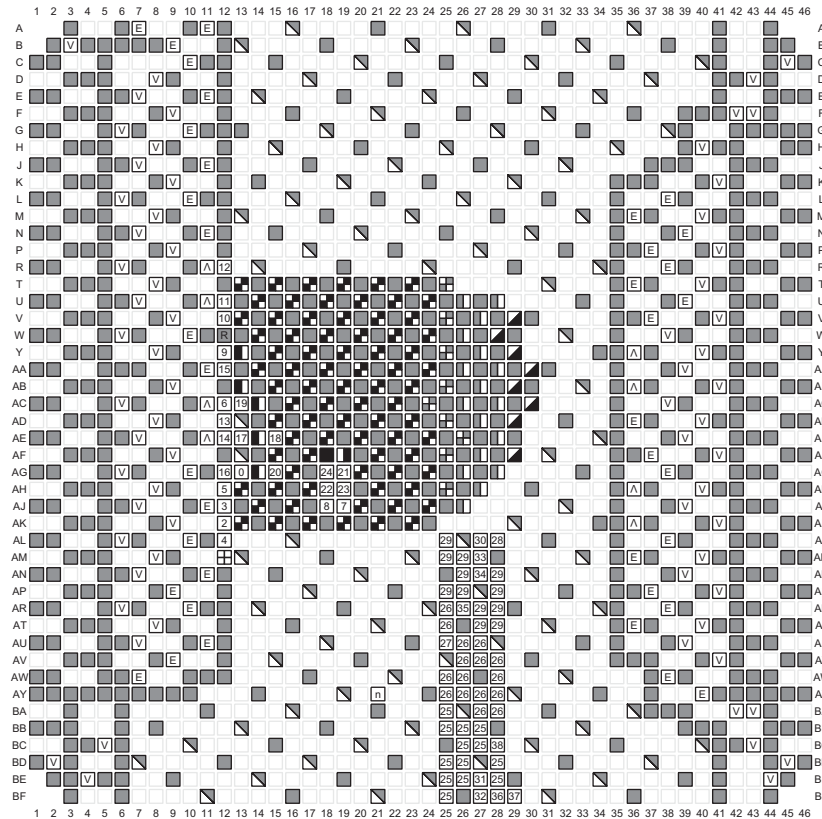

Figure 3-115: FLVB2104 Package—XCVU5P and XCVU7P and FLRB2104 Package—XQVU7P I/O Bank Diagram



Power Pins	Dedicated Pins	Multi-Function I/O Pins
■ GND	0 CCLK_0	25 A[16 to 28]
⊕ VBATT	2 D00_MOSI_0	26 A[00 to 15]_D[16 to 31]
▢ VCCAUX_IO	3 D01_DIN_0	27 CSI_ADV_B
▣ VCCAUX	4 D02_0	28 DOUT_CSO_B
▤ VCCINT	5 D03_0	29 D[04 to 15]
▥ VCCINT_IO	6 DONE_0	30 EMCCLK
▦ VCCO	7 DXP	31 FOE_B
▧ VCCBRAM	8 DXN	32 FWE_FCS2_B
▨ VCCADC	9 INIT_B_0	33 I2C_SCLK
▩ GNDADC	10 M0_0	34 PERSTN1_I2C_SDA
▪ NC	11 M1_0	35 PERSTN0
▫ MGTAVCC	12 M2_0	38 SMBALERT
▬ MGTAVTT	13 POR_OVERRIDE	36 RS0
▭ MGTVCCAUX	14 PROGRAM_B_0	37 RS1
▮ RSVDGND	15 PUDC_B_0	
	16 RDWR_FCS_B_0	
	17 TCK_0	
	18 TDI_0	
	19 TDO_0	
	20 TMS_0	
	21 VP	
	22 VN	
	23 VREFF	
	24 VREFN	

ug575_c3_100_030817

Figure 3-116: FLVB2104 Package—XCVU5P and XCVU7P and FLRB2104 Package—XQVU7P Configuration/Power Diagram

FLGB2104 (XCVU9P)

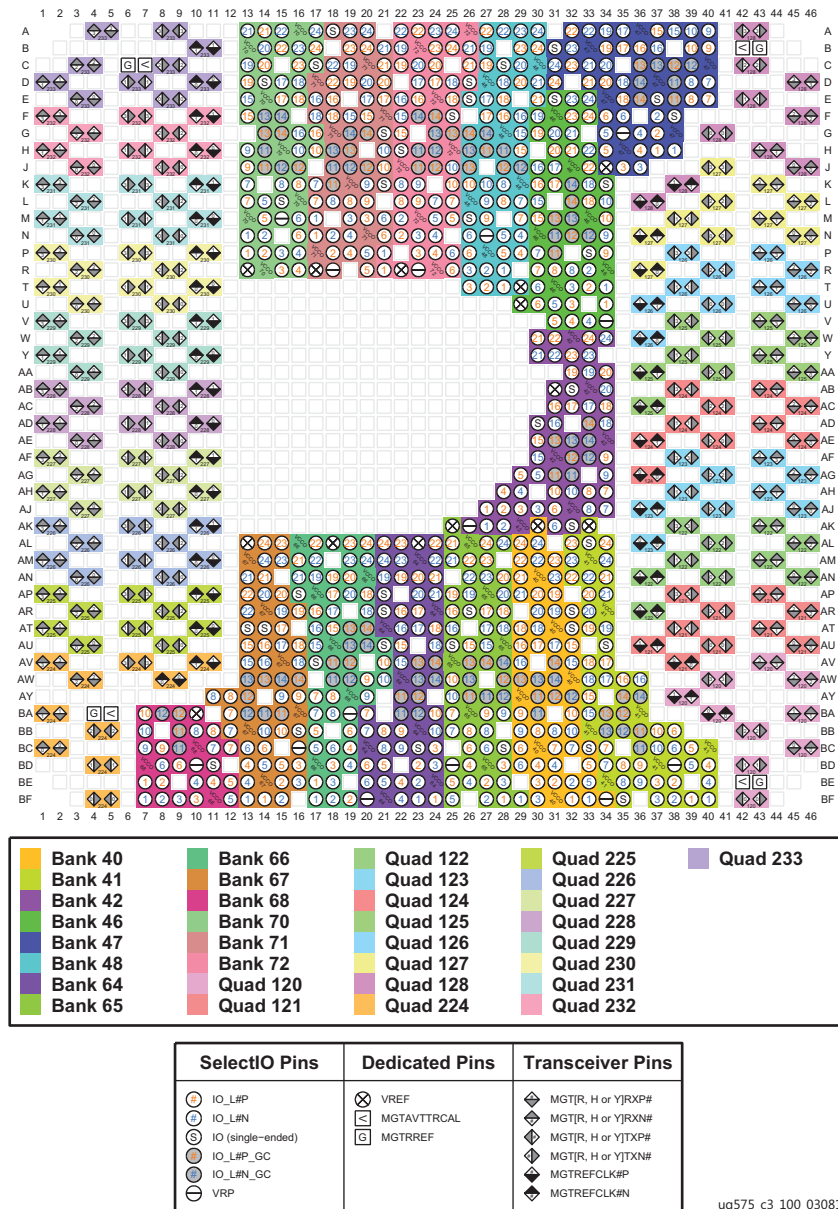

ug575_c3_100_030817

Figure 3-117: FLGB2104 Package—XCVU9P I/O Bank Diagram

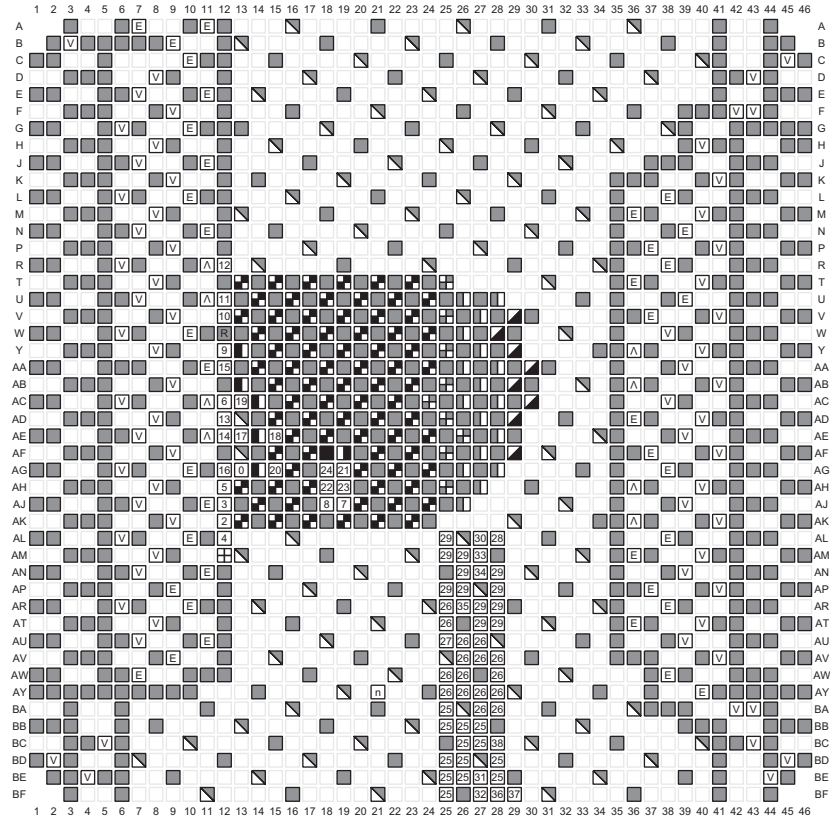

Power Pins	Dedicated Pins	Multi-Function I/O Pins
GND	0 CCLK_0	25 A[16 to 28]
VBATT	2 D00_MOSI_0	26 A[00 to 15]_D[16 to 31]
VCCAUX_IO	3 D01_DIN_0	27 CSI_ADV_B
VCCAUX	4 D02_0	28 DOUT_CSO_B
VCCINT	5 D03_0	29 D[04 to 15]
VCCINT_IO	6 DONE_0	30 EMCCLK
VCCO	7 DXP	31 FOE_B
VCCBRAM	8 DXN	32 FWE_FCS2_B
VCCADC	9 INIT_B_0	33 I2C_SCLK
GNDADC	10 M0_0	34 PERSTN1_I2C_SDA
n NC	11 M1_0	35 PERSTN0
E MGTAVCC	12 M2_0	38 SMBALERT
V MGTAVTT	13 POR_OVERRIDE	36 RS0
A MGTVCCAUX	14 PROGRAM_B_0	37 RS1
R RSVDGND	15 PUDC_B_0	
	16 RDWR_FCS_B_0	
	17 TCK_0	
	18 TDI_0	
	19 TDO_0	
	20 TMS_0	
	21 VP	
	22 VN	
	23 VREFP	
	24 VREFN	

ug575_c3_100_030817

Figure 3-118: FLGB2104 Package—XCVU9P Configuration/Power Diagram

FLGB2104 (XCVU11P)

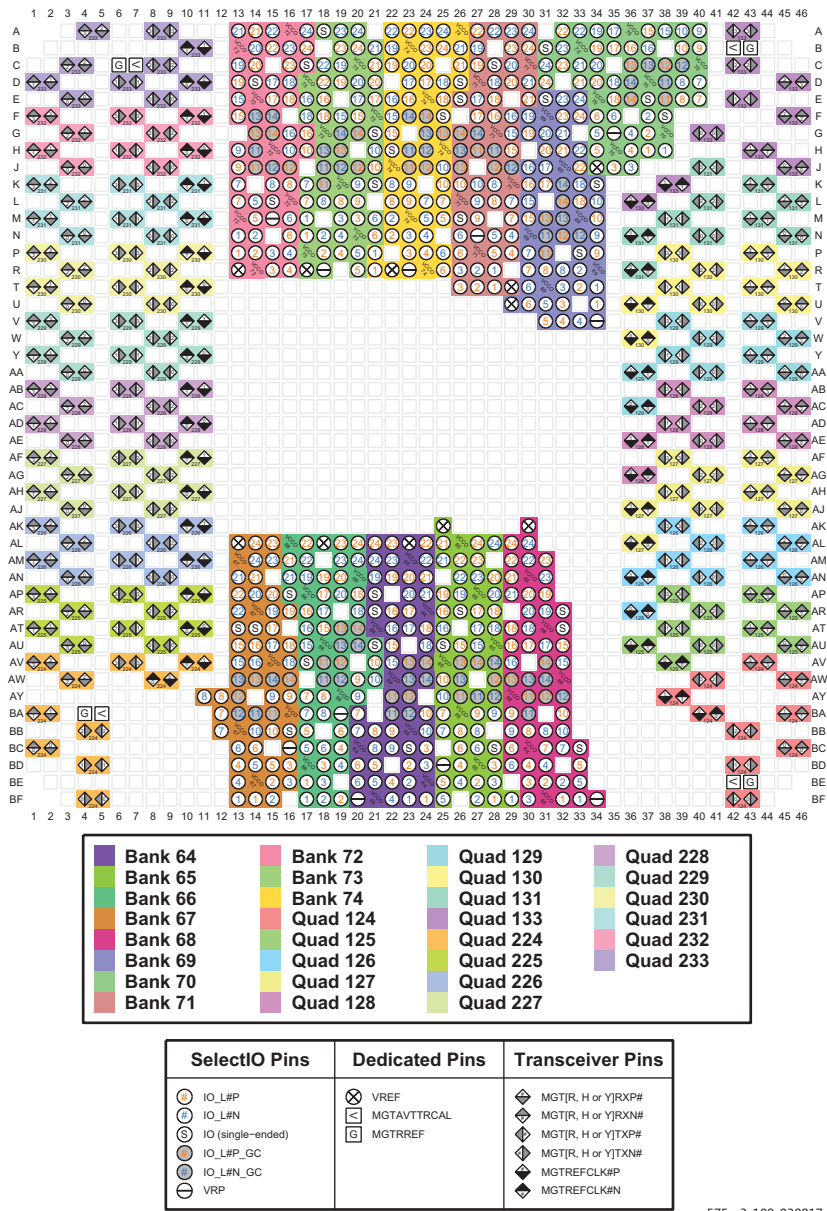
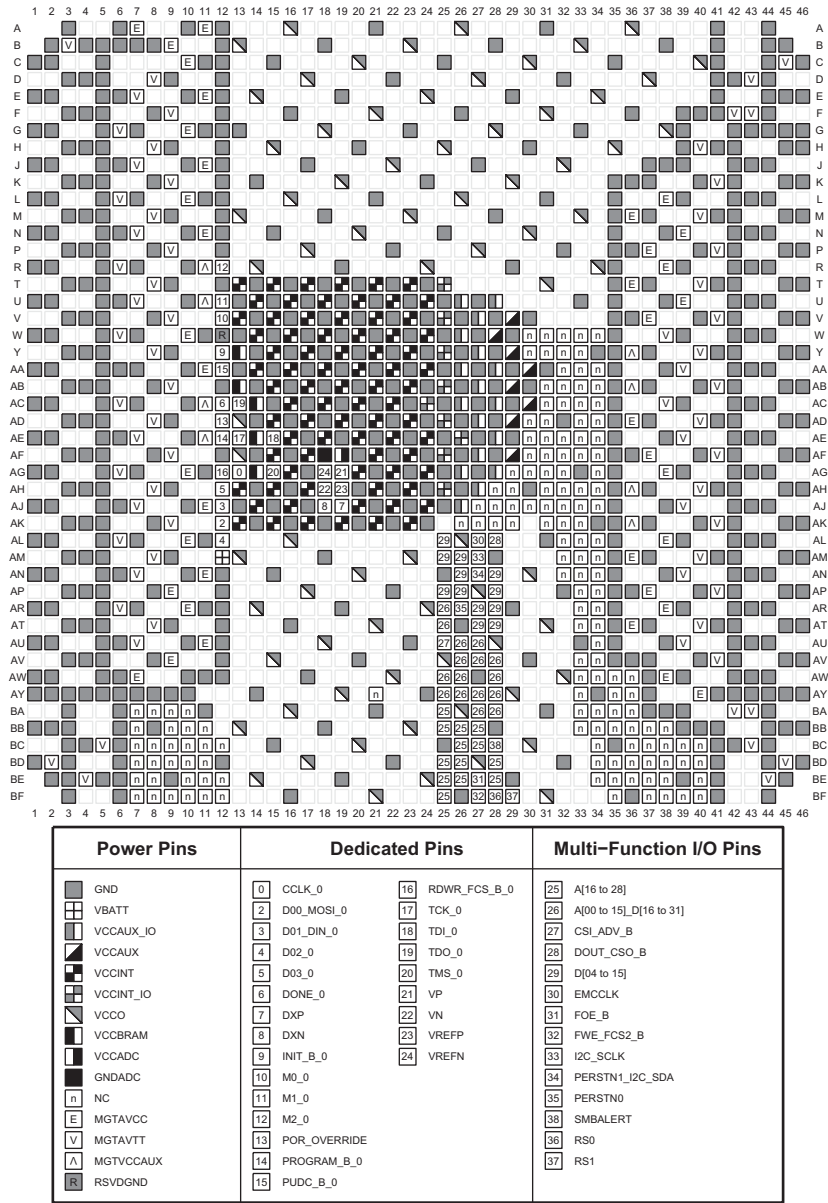

Figure 3-119: FLGB2104 Package—XCVU11P I/O Bank Diagram



ug575_c3_100_030817

Figure 3-120: FLGB2104 Package—XCVU11P Configuration/Power Diagram

FHGB2104 (XCVU13P)

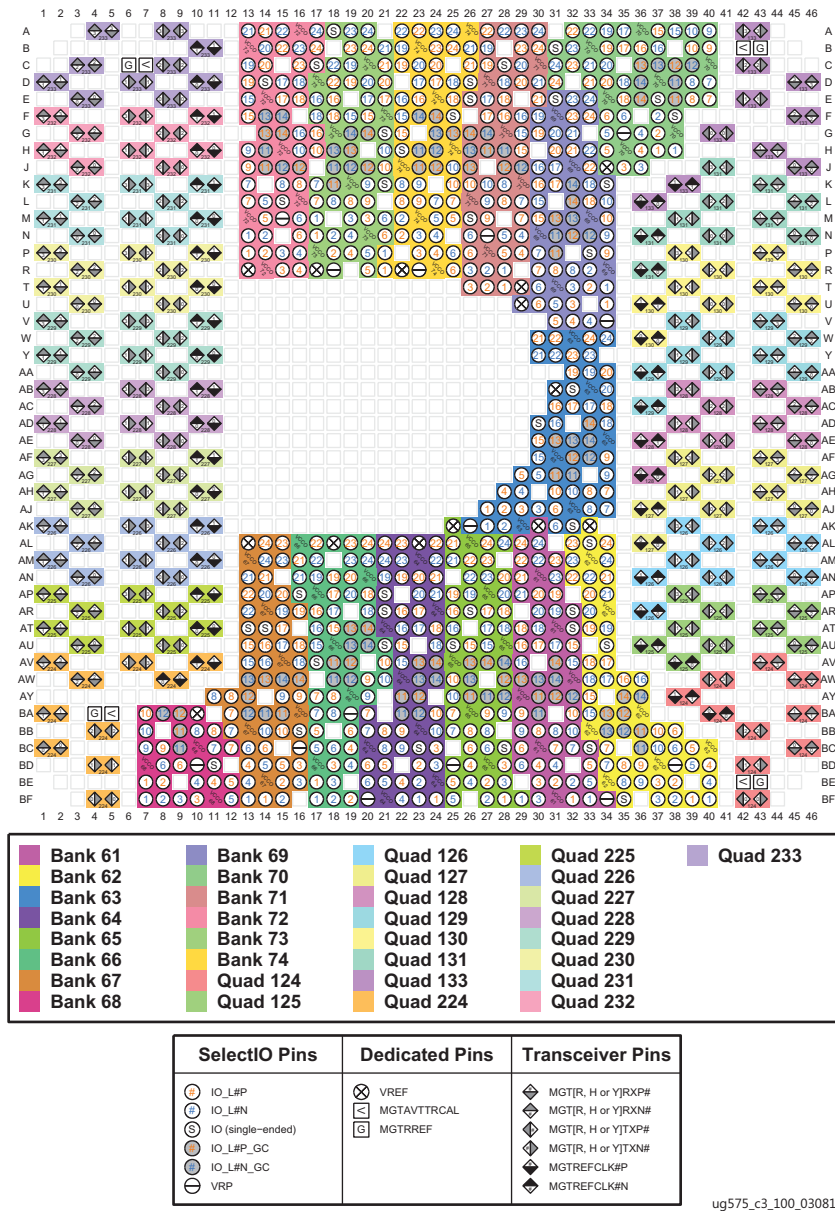
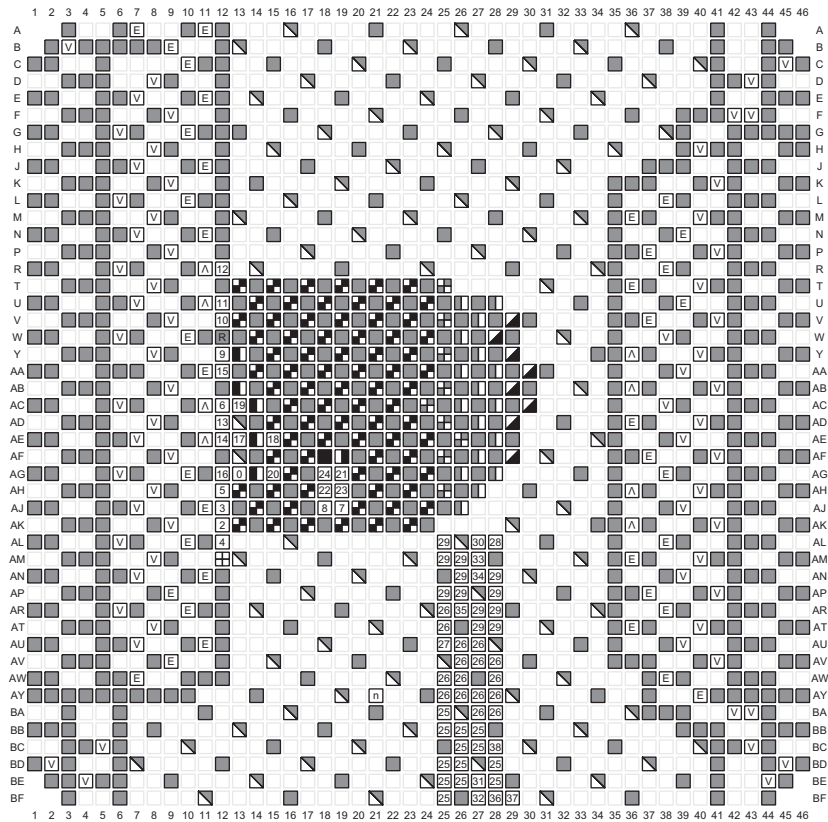

Figure 3-121: FHGB2104 Package—XCVU13P I/O Bank Diagram



Power Pins	Dedicated Pins		Multi-Function I/O Pins
GND	0 CCLK_0	16 RDWR_FCS_B_0	25 A[16 to 28]
VBATT	2 D00_MOSI_0	17 TCK_0	26 A[00 to 15]_D[16 to 31]
VCCAUX_I/O	3 D01_DIN_0	18 TDI_0	27 CSI_ADV_B
VCCAUX	4 D02_0	19 TDO_0	28 DOUT_CSO_B
VCCINT	5 D03_0	20 TMS_0	29 D[04 to 15]
VCCINT_I/O	6 DONE_0	21 VP	30 EMCCLK
VCCO	7 DXP	22 VN	31 FOE_B
VCCBRAM	8 DXN	23 VREFP	32 FWE_FCS2_B
VCCADC	9 INIT_B_0	24 VREFN	33 I2C_SCLK
GNDADC	10 M0_0		34 PERSTN1_I2C_SDA
n NC	11 M1_0		35 PERSTN0
E MGTAVCC	12 M2_0		38 SMBALERT
V MGTAVTT	13 POR_OVERRIDE		36 RSO
A MGTVCCAUX	14 PROGRAM_B_0		37 RS1
R RSVDCND	15 PUDC_B_0		

ug575_c3_100_030817

Figure 3-122: FHGB2104 Package—XCVU13P Configuration/Power Diagram

FLVC2104 (XCVU5P and XCVU7P)

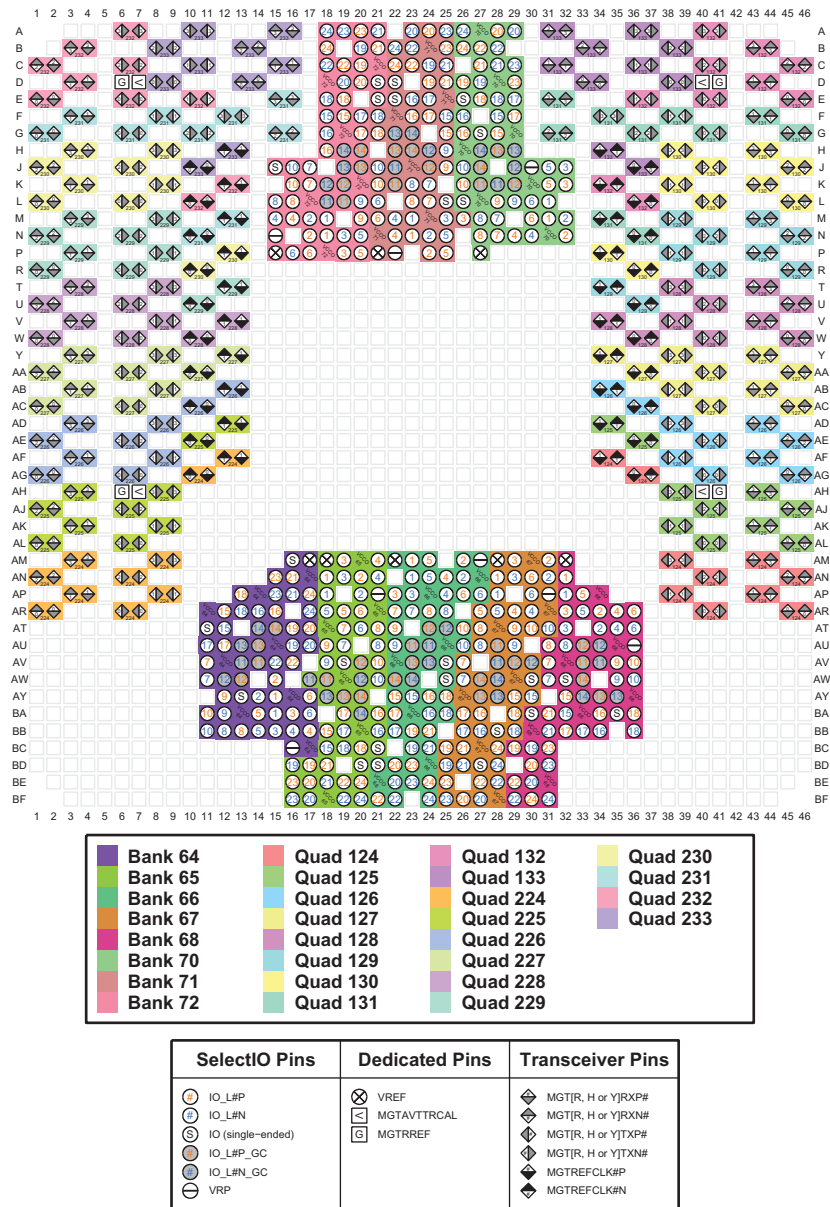

ug575_c3_100_030817

Figure 3-123: FLVC2104 Package—XCVU5P and XCVU7P I/O Bank Diagram

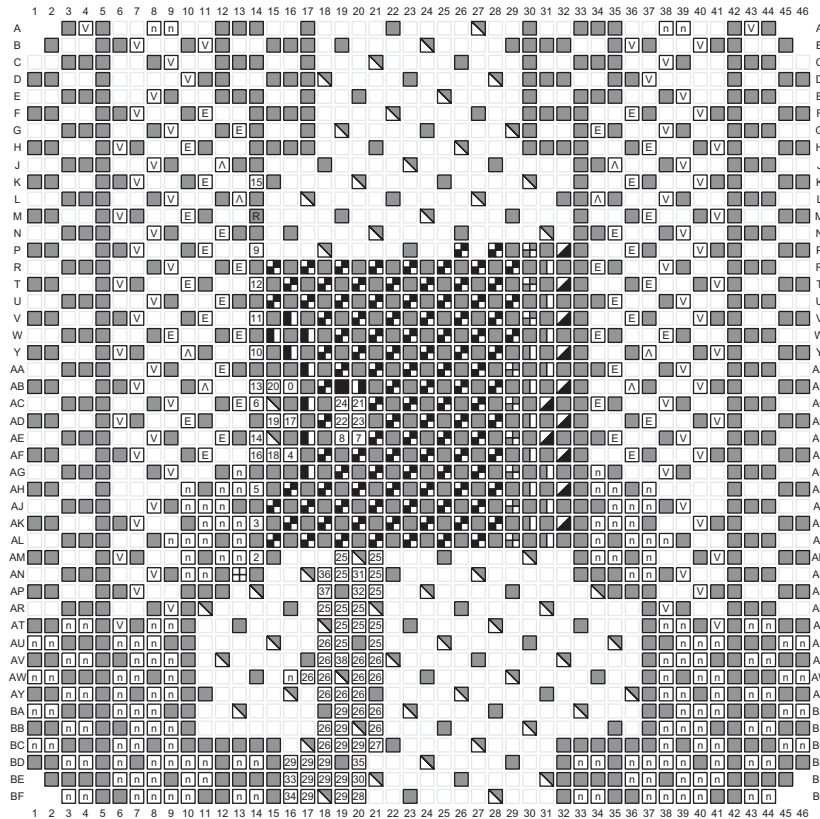

Power Pins	Dedicated Pins	Multi-Function I/O Pins
GND	0 CCLK_0	25 A[16 to 28]
VBATT	2 D00_MOSI_0	26 A[00 to 15]_D[16 to 31]
VCCAUX_IO	3 D01_DIN_0	27 CSI_ADV_B
VCCAUX	4 D02_0	28 DOUT_CSO_B
VCCINT	5 D03_0	29 D[04 to 15]
VCCINT_IO	6 DONE_0	30 EMCCLK
VCCO	7 DXP	31 FOE_B
VCCBRAM	8 DXN	32 FWE_FCS2_B
VCCADC	9 INIT_B_0	33 I2C_SCLK
GNDADC	10 M0_0	34 PERSTN1_I2C_SDA
NC	11 M1_0	35 PERSTN0
MGTAVCC	12 M2_0	36 SMBALERT
MGTAVTT	13 POR_OVERRIDE	37 RS0
MGTVCCAUX	14 PROGRAM_B_0	38 RS1
RSVDGND	15 PUDC_B_0	
	16 RDWR_FCS_B_0	
	17 TCK_0	
	18 TDI_0	
	19 TDO_0	
	20 TMS_0	
	21 VP	
	22 VDN	
	23 VREFP	
	24 VREFN	

ug575_c3_100_030817

Figure 3-124: FLVC2104 Package—XCVU5P and XCVU7P Configuration/Power Diagram

FLGC2104 (XCVU9P)

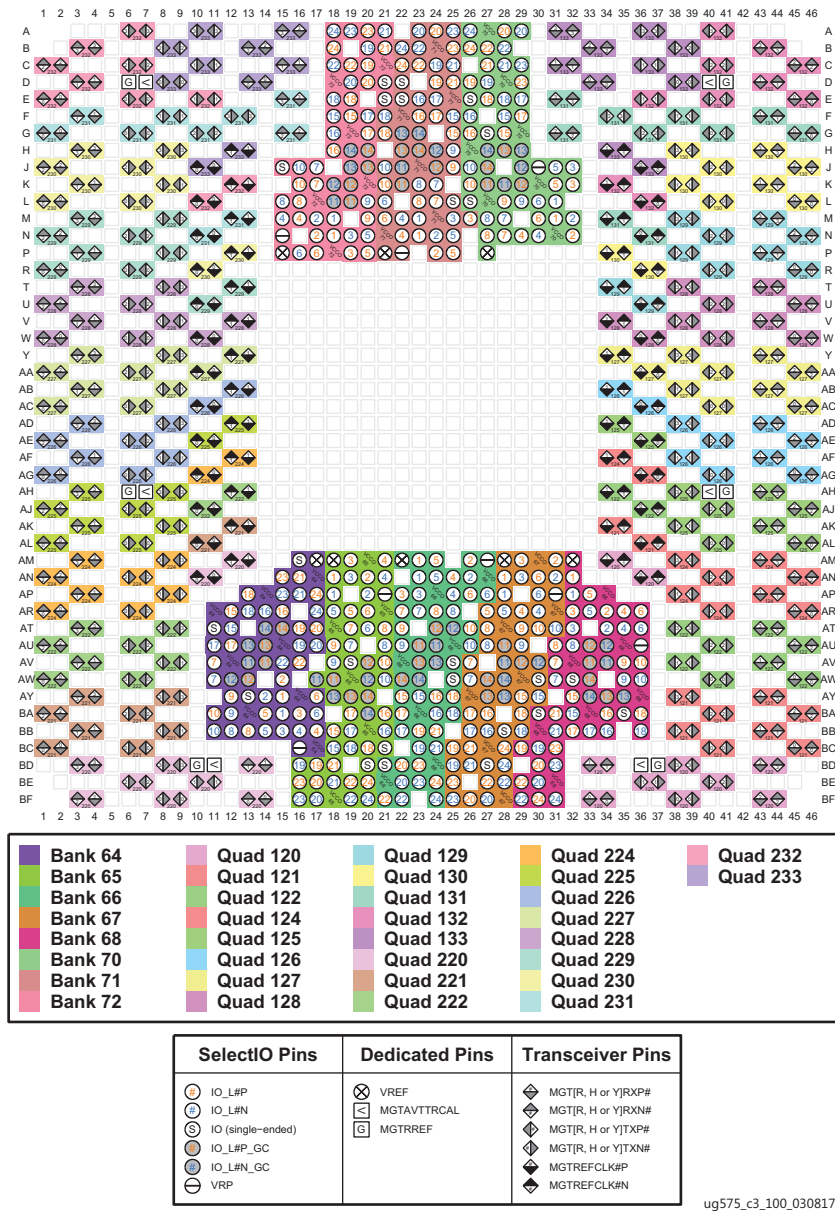

ug575_c3_100_030817

Figure 3-125: FLGC2104 Package—XCVU9P I/O Bank Diagram

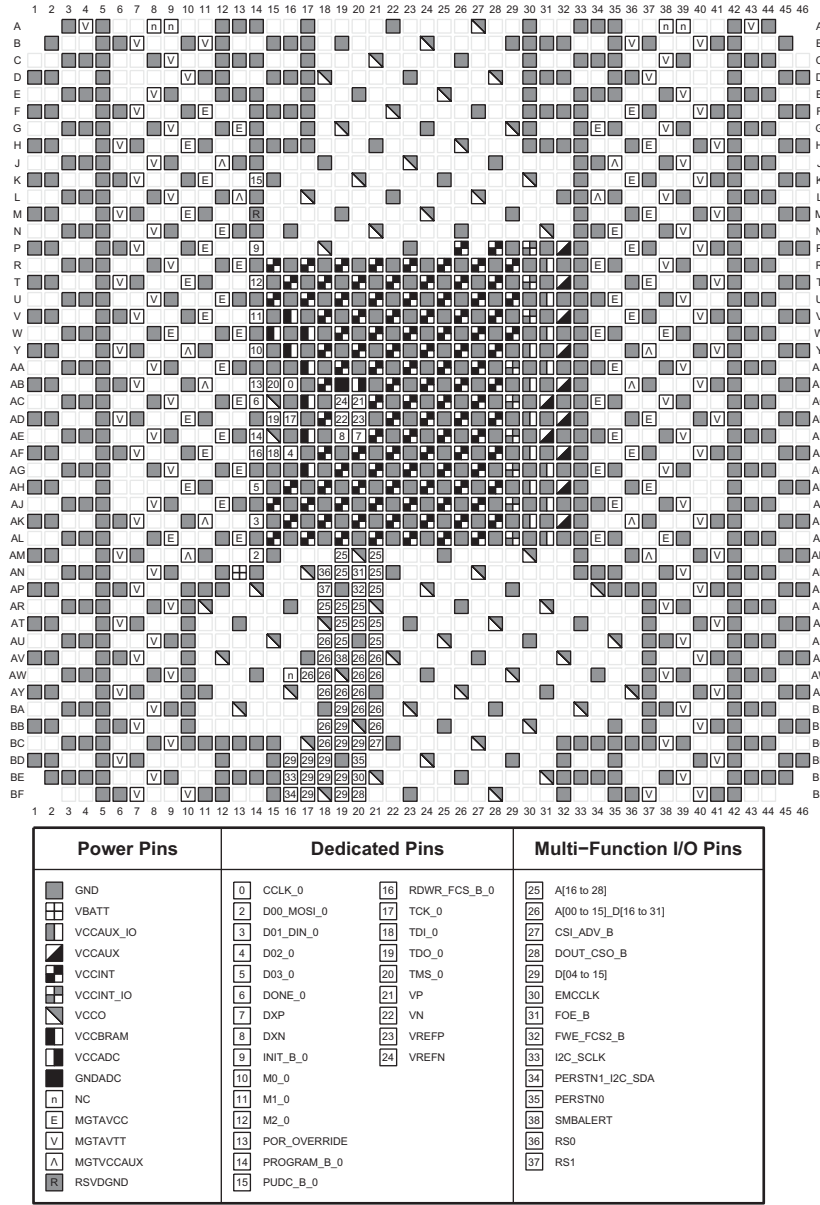

Figure 3-126: FLGC2104 Package—XCVU9P Configuration/Power Diagram

FLGC2104 (XCVU11P) and FLRC2104 (XQVU11P)

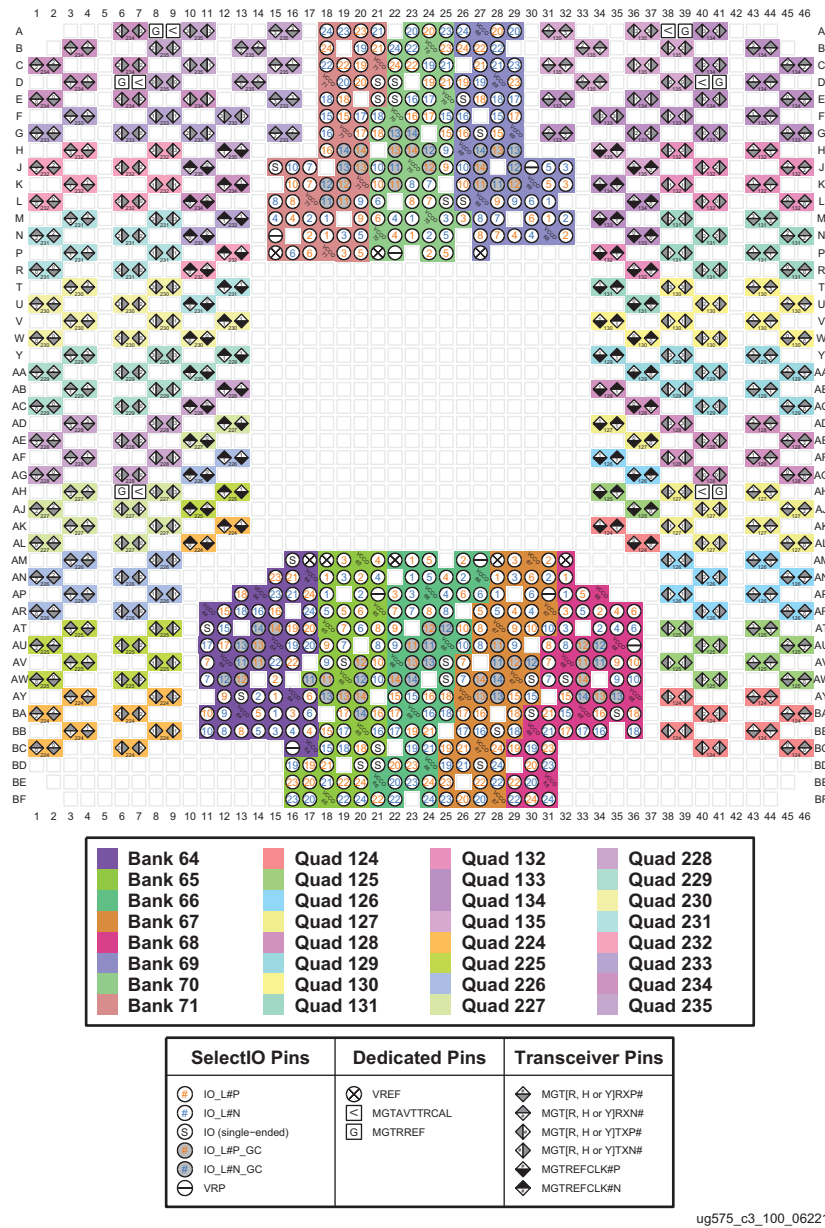
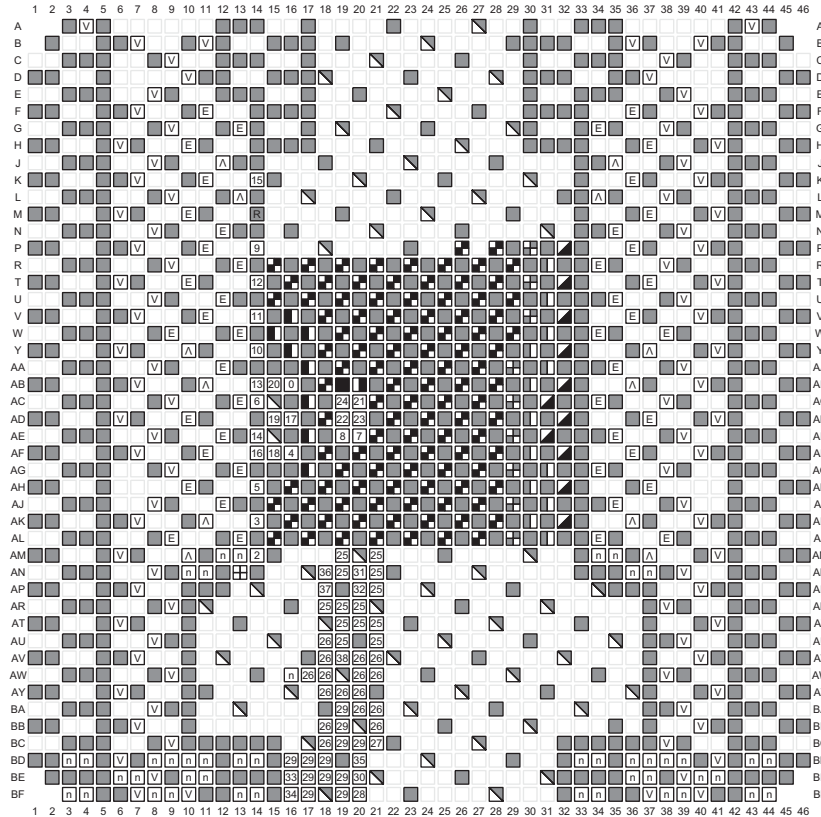

Figure 3-127: FLGC2104 Package—XCVU11P and FLRC2104 Package—XQVU11P I/O Bank Diagram



Power Pins	Dedicated Pins	Multi-Function I/O Pins
GND	0 CCLK_0	25 A[16 to 28]
VBATT	2 D00_MOSI_0	26 A[00 to 15]_D[16 to 31]
VCCAUX_IO	3 D01_DIN_0	27 CSI_ADV_B
VCCAUX	4 D02_0	28 DOUT_CSO_B
VCCINT	5 D03_0	29 D[04 to 15]
VCCINT_IO	6 DONE_0	30 EMCCLK
VCCO	7 DXP	31 FOE_B
VCCBRAM	8 DXN	32 FWE_FCS2_B
VCCADC	9 INIT_B_0	33 I2C_SCLK
GNDADC	10 M0_0	34 PERSTN1_I2C_SDA
NC	11 M1_0	35 PERSTN0
MGTA VCC	12 M2_0	38 SMBALERT
MGTA VTT	13 POR_OVERRIDE	36 RS0
MGT VCCAUX	14 PROGRAM_B_0	37 RS1
RSV D GND	15 PUDC_B_0	
	16 RDWR_FCS_B_0	
	17 TCK_0	
	18 TDI_0	
	19 TDO_0	
	20 TMS_0	
	21 VP	
	22 VN	
	23 VREFF	
	24 VREFN	

ug575_c3_100_062217

Figure 3-128: FLGC2104 Package—XCvu11P and FLRC2104 Package—XQvu11P Configuration/Power Diagram

FHGC2104 (XCVU13P)

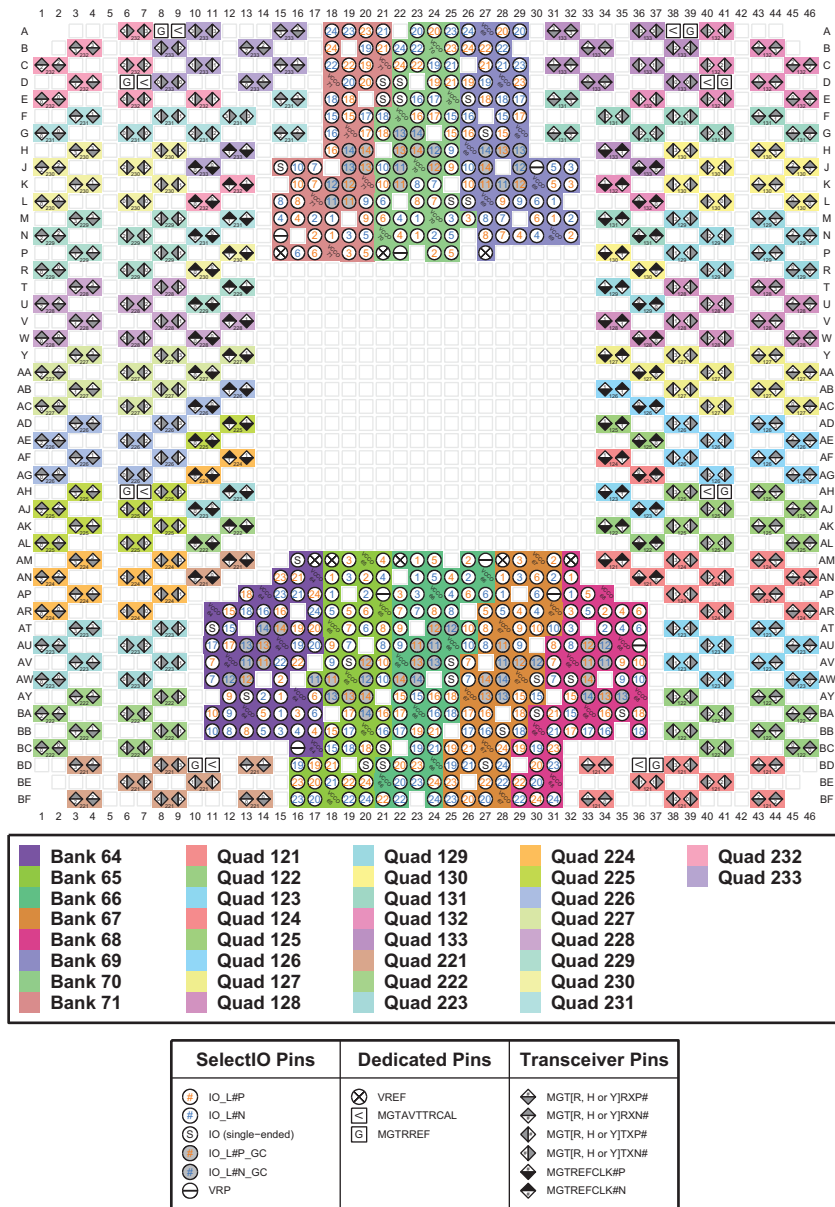

ug575_c3_100_030817

Figure 3-129: FHGC2104 Package—XCVU13P I/O Bank Diagram

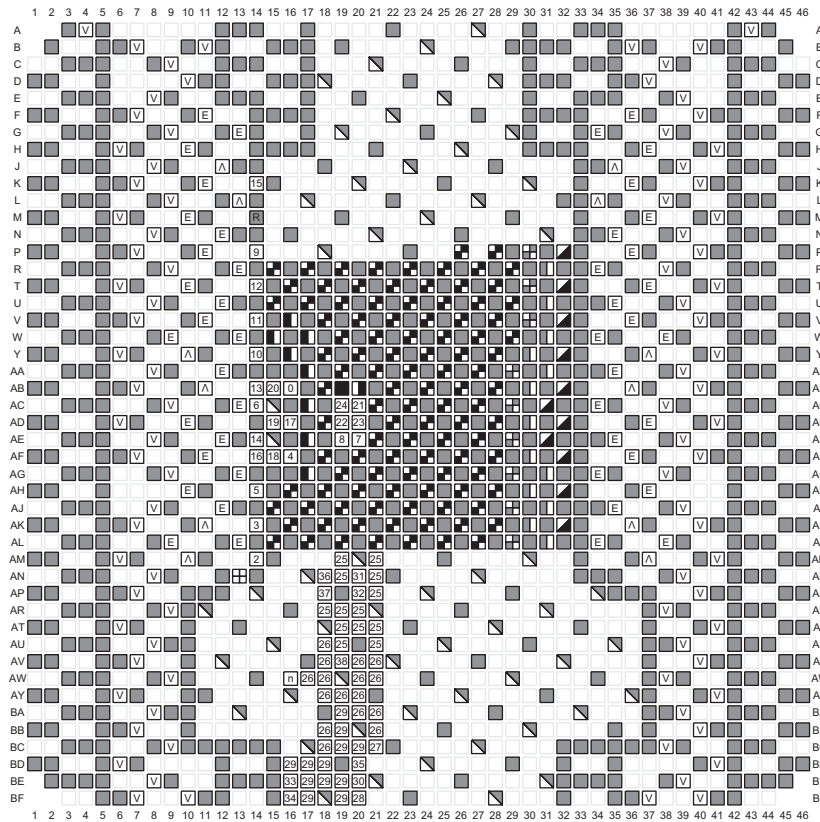

Power Pins	Dedicated Pins	Multi-Function I/O Pins
GND	0 CCLK_0	25 A[16 to 28]
VBATT	2 D00_MOSI_0	26 A[00 to 15], D[16 to 31]
VCCAUX_IO	3 D01_DIN_0	27 CSI_ADV_B
VCCAUX	4 D02_0	28 DOUT_CSO_B
VCCINT	5 D03_0	29 D[04 to 15]
VCCINT_IO	6 DONE_0	30 EMCCLK
VCCO	7 DXP	31 FOE_B
VCCBRAM	8 DXN	32 FWE_FCS2_B
VCCADC	9 INIT_B_0	33 I2C_SCLK
GNDADC	10 M0_0	34 PERSTN1_I2C_SDA
n NC	11 M1_0	35 PERSTN0
E MGTAVCC	12 M2_0	38 SMBALERT
V MGTAVTT	13 POR_OVERRIDE	36 RS0
A MGTVCCAUX	14 PROGRAM_B_0	37 RS1
R RSV D GND	15 PUDC_B_0	
	16 RDWR_FCS_B_0	
	17 TCK_0	
	18 TDI_0	
	19 TDO_0	
	20 TMS_0	
	21 VP	
	22 VN	
	23 VREFP	
	24 VREFN	

ug575_c3_100_030817

Figure 3-130: FHGC2104 Package—XCVCU13P Configuration/Power Diagram

FSGD2104 (XCVU9P)

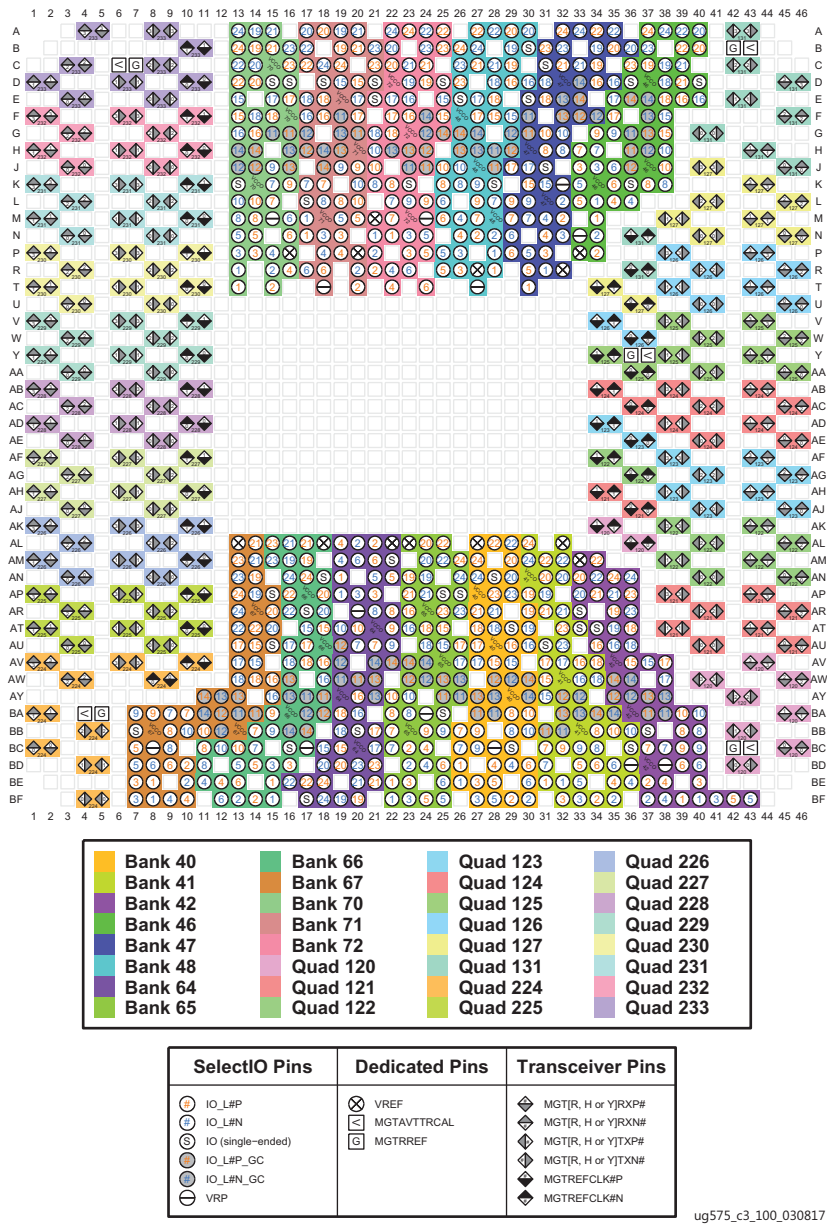
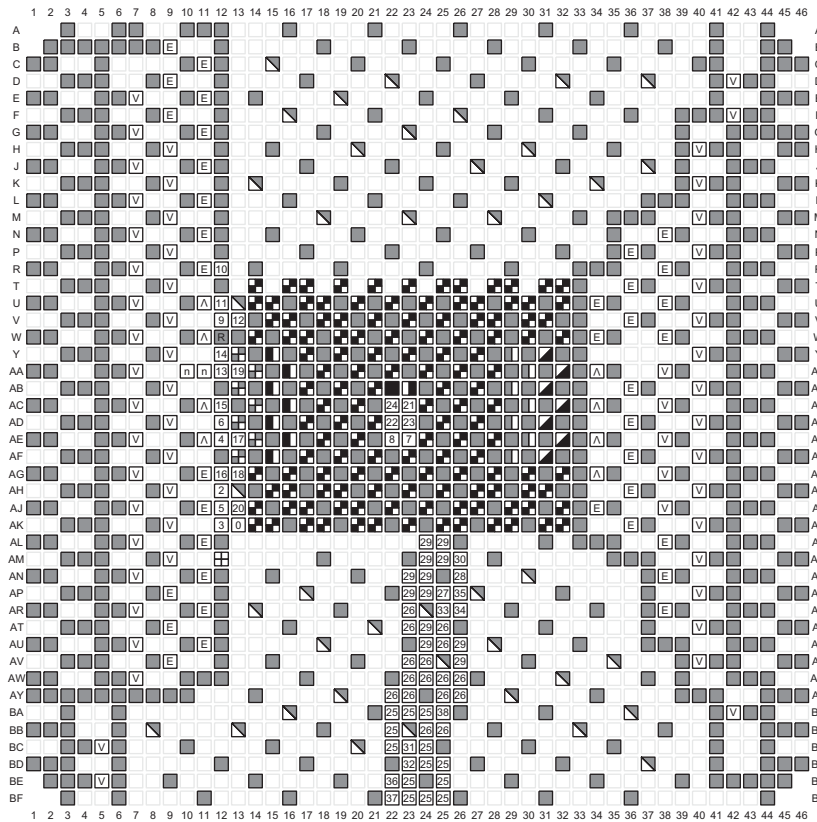

Figure 3-131: FSGD2104 Package—XCVU9P I/O Bank Diagram



Power Pins	Dedicated Pins		Multi-Function I/O Pins
GND	0 CCLK_0	16 RDWR_FCS_B_0	25 A[16 to 28]
VBATT	2 D00_MOSI_0	17 TCK_0	26 A[00 to 15]_D[16 to 31]
VCCAUX_IO	3 D01_DIN_0	18 TDI_0	27 CSI_ADV_B
VCCAUX	4 D02_0	19 TDO_0	28 DOUT_CSO_B
VCCINT	5 D03_0	20 TMS_0	29 D[04 to 15]
VCCINT_IO	6 DONE_0	21 VP	30 EMCCLK
VCCO	7 DXP	22 VN	31 FOE_B
VCCBRAM	8 DXN	23 VREFP	32 FWE_FCS2_B
VCCADC	9 INIT_B_0	24 VREFN	33 I2C_SCLK
GNDADC	10 M0_0		34 PERSTN1_I2C_SDA
NC	11 M1_0		35 PERSTN0
MGTAVCC	12 M2_0		38 SMBALERT
MGTAVTT	13 POR_OVERRIDE		36 RS0
MGTVCCAUX	14 PROGRAM_B_0		37 RS1
RSVDGND	15 PUDC_B_0		

ug575_c3_100_030817

Figure 3-132: FSGD2104 Package—XCVU9P Configuration/Power Diagram

FSGD2104 (XCVU11P)

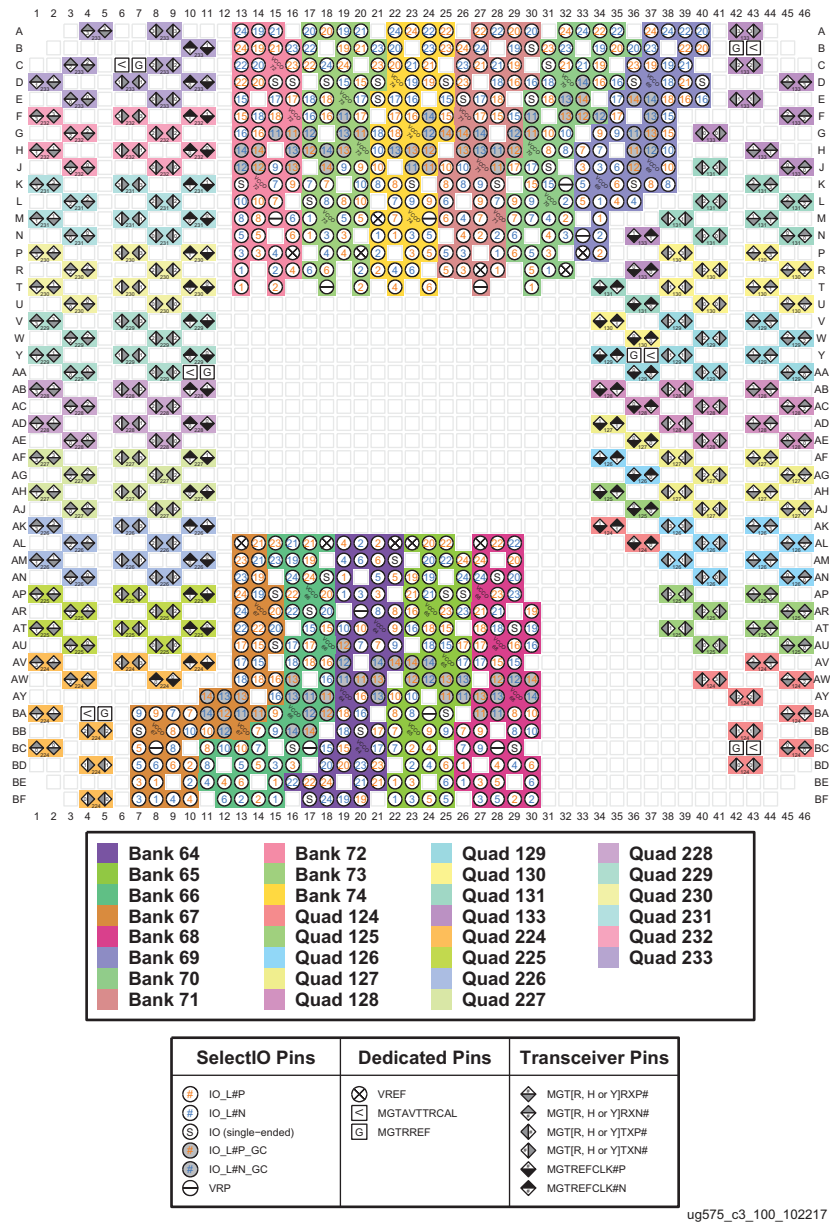
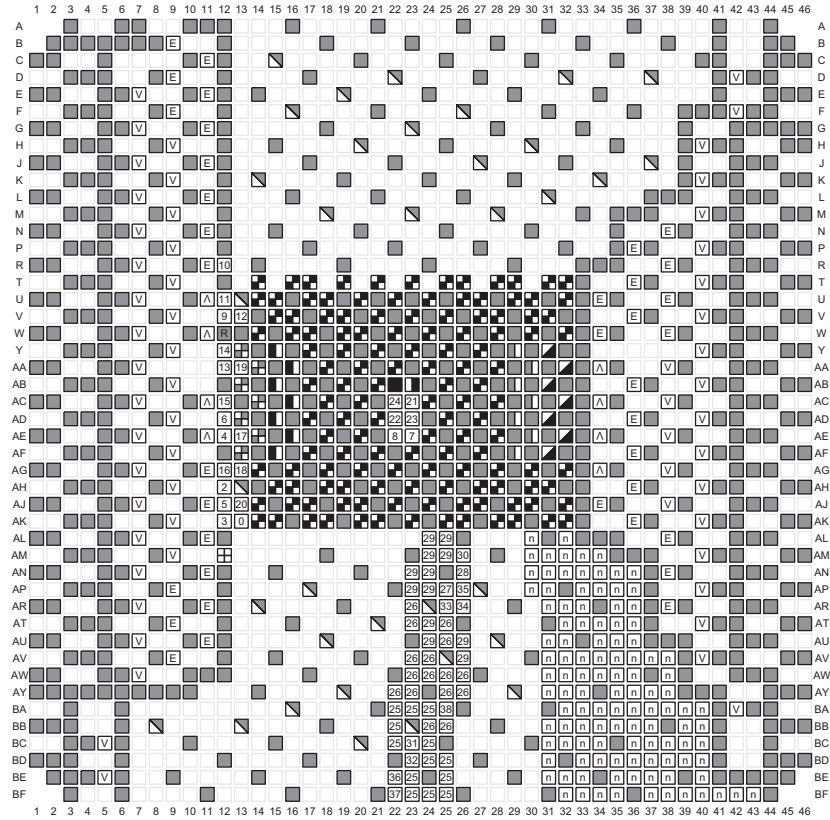

Figure 3-133: FSGD2104 Package—XCVU11P I/O Bank Diagram



Power Pins	Dedicated Pins		Multi-Function I/O Pins
GND	0 CCLK_0	16 RDWR_FCS_B_0	25 A[16 to 28]
VBATT	2 D00_MOSI_0	17 TCK_0	26 A[00 to 15]_D[16 to 31]
VCCAUX_IO	3 D01_DIN_0	18 TDI_0	27 CSI_ADV_B
VCCAUX	4 D02_0	19 TDO_0	28 DOUT_CSO_B
VCCINT	5 D03_0	20 TMS_0	29 D[04 to 15]
VCCINT_IO	6 DONE_0	21 VP	30 EMCCLK
VCCO	7 DXP	22 VN	31 FOE_B
VCCBRAM	8 DXN	23 VREFP	32 FWE_FCS2_B
VCCADC	9 INIT_B_0	24 VREFN	33 I2C_SCLK
GNDADC	10 M0_0		34 PERSTN1_I2C_SDA
n NC	11 M1_0		35 PERSTN0
E MGTAVCC	12 M2_0		36 SMBALERT
V MGTAVTT	13 POR_OVERRIDE		37 RS0
A MGTVCCAUX	14 PROGRAM_B_0		37 RS1
R RSDVGGND	15 PUDC_B_0		

ug575_c3_100_102217

Figure 3-134: FSGD2104 Package—XCVU11P Configuration/Power Diagram

FIGD2104 (XCVU13P)

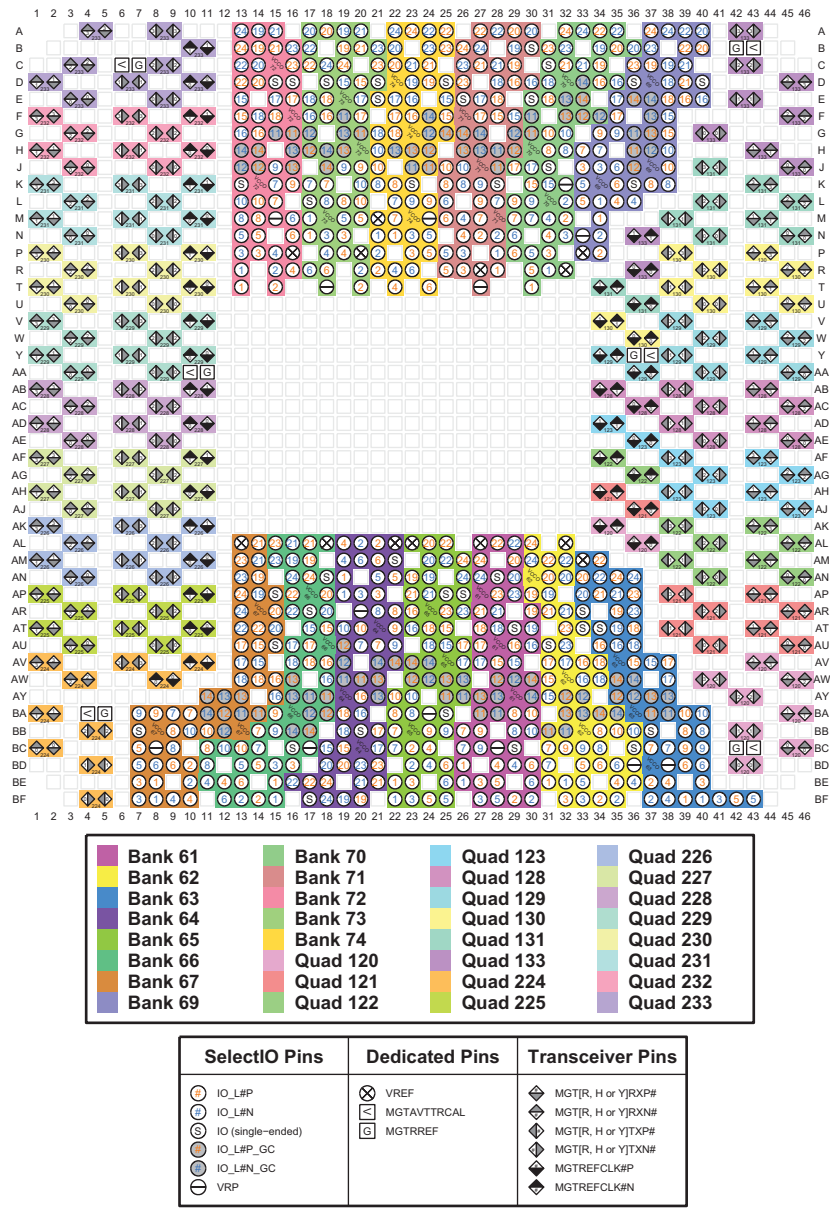

ug575_c3_100_062217

Figure 3-135: FIGD2104 Package—XCVU13P I/O Bank Diagram

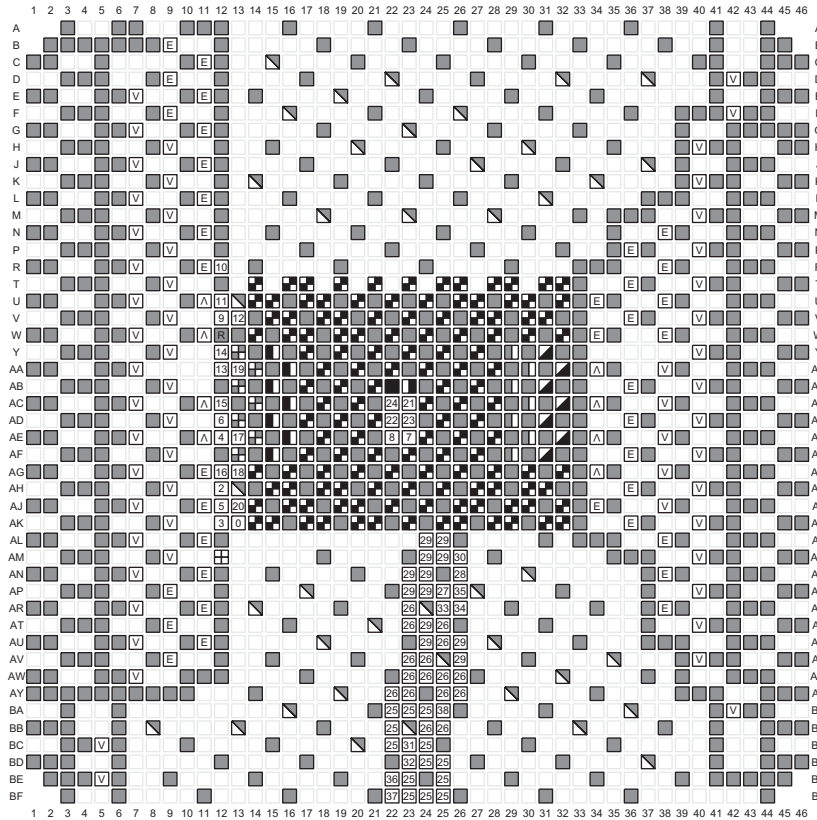

Power Pins	Dedicated Pins	Multi-Function I/O Pins
GND	0 CCLK_0	25 A[16 to 28]
VBATT	2 D00_MOSI_0	26 A[00 to 15]_D[16 to 31]
VCCAUX_IO	3 D01_DIN_0	27 CSI_ADV_B
VCCAUX	4 D02_0	28 DOUT_CSO_B
VCCINT	5 D03_0	29 D[04 to 15]
VCCINT_IO	6 DONE_0	30 EMCCLK
VCCO	7 DXP	31 FOE_B
VCCBRAM	8 DXN	32 FWE_FCS2_B
VCCADC	9 INIT_B_0	33 I2C_SCLK
GNDADC	10 M0_0	34 PERSTN1_I2C_SDA
NC	11 M1_0	35 PERSTN0
MGTAVCC	12 M2_0	36 SMBALERT
MGTAVTT	13 POR_OVERRIDE	37 RSO
MGTVCCAUX	14 PROGRAM_B_0	38 RS1
RSVDGND	15 PUDC_B_0	
	16 RDWR_FCS_B_0	
	17 TCK_0	
	18 TDI_0	
	19 TDO_0	
	20 TMS_0	
	21 VP	
	22 VN	
	23 VREFP	
	24 VREFN	

ug575_c3_100_062217

Figure 3-136: FIGD2104 Package—XCVU13P Configuration/Power Diagram

FIGD2104 (XCVU27P)

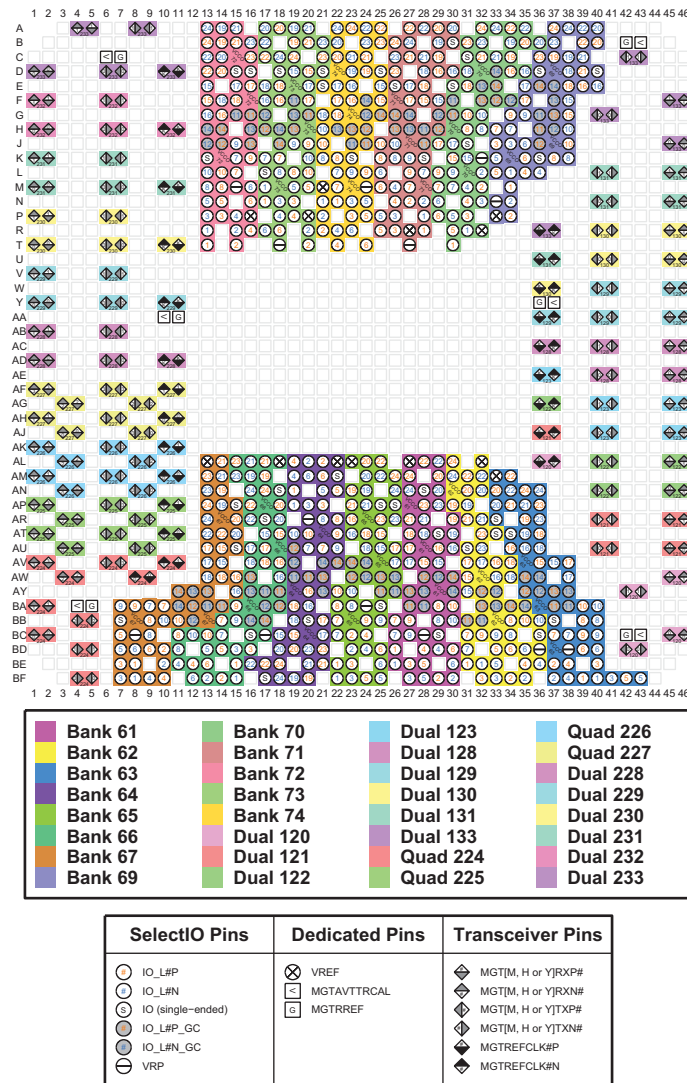

ug575_c3_xcvu27pfigd2104_010819

Figure 3-137: FIGD2104 Package—XCVU27P I/O Bank Diagram

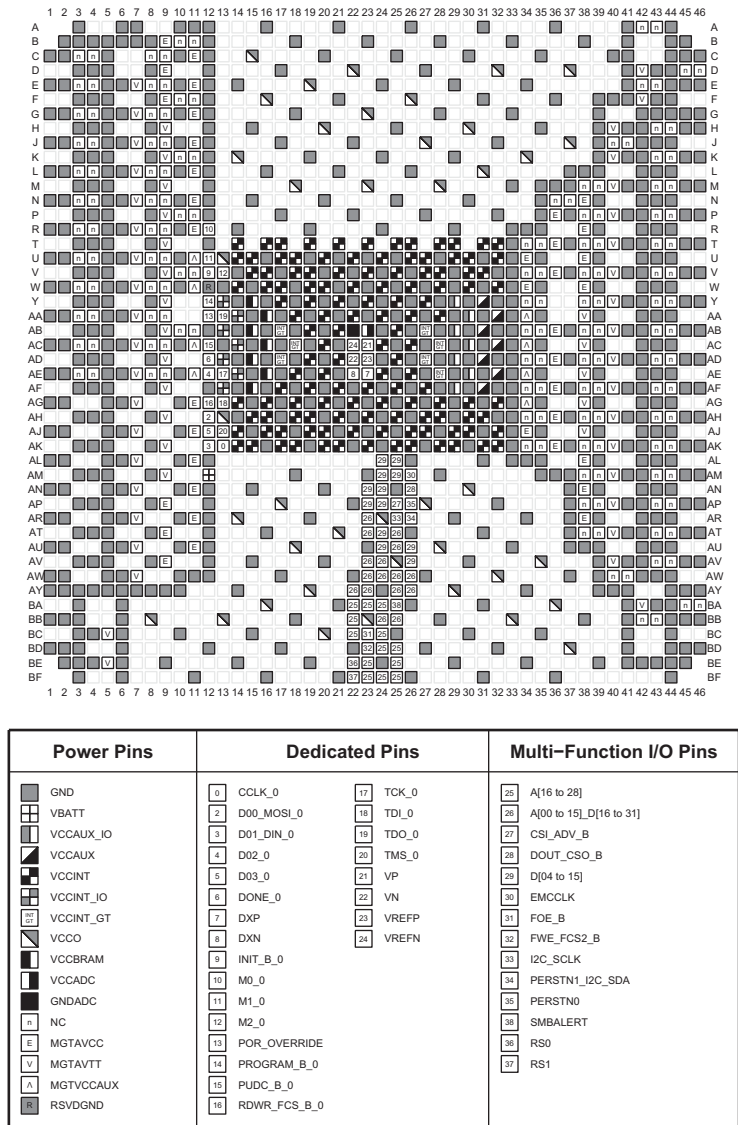

ug575_c3_xcvu27pfigd2104_010819

Figure 3-138: FIGD2104 Package—XC7VU27P Configuration/Power Diagram

FIGD2104 (XCVU29P)

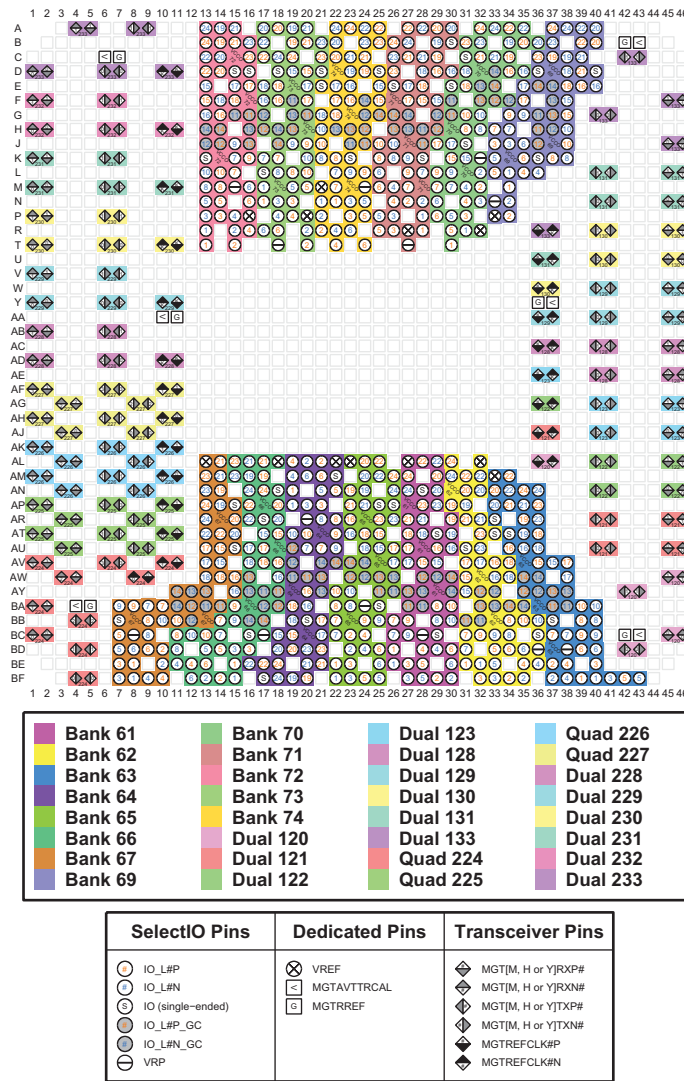

Figure 3-139: FIGD2104 Package—XCVU29P I/O Bank Diagram

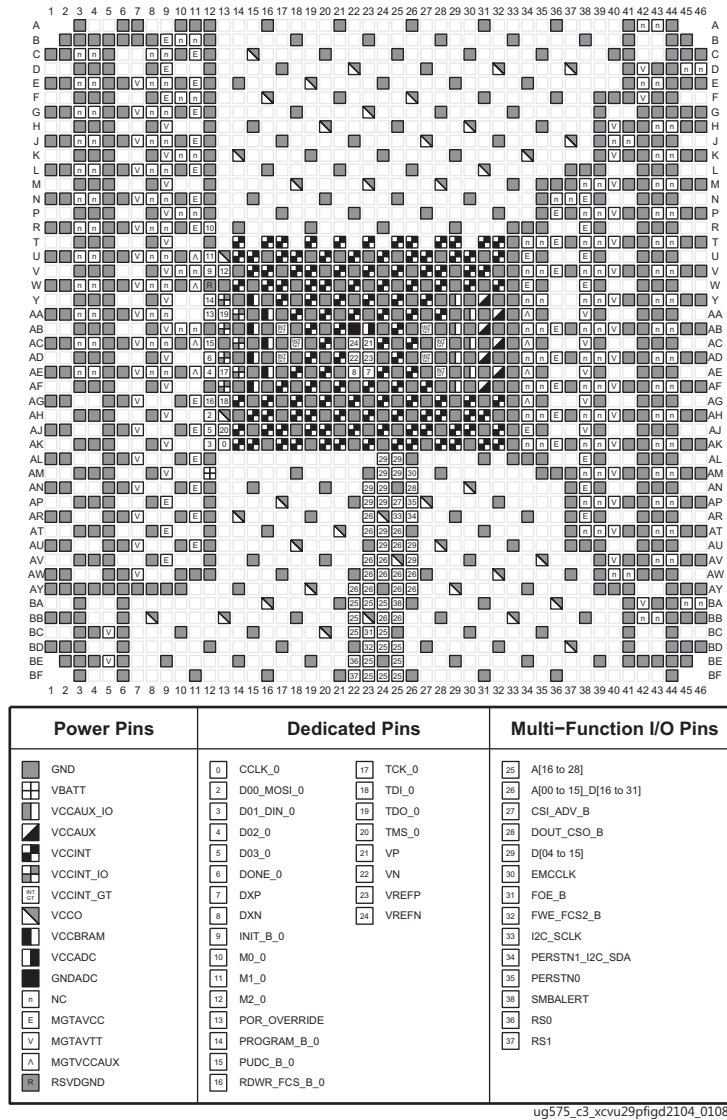

Figure 3-140: FIGD2104 Package—XCVU29P Configuration/Power Diagram

FSVH2104 (XCVU33P)

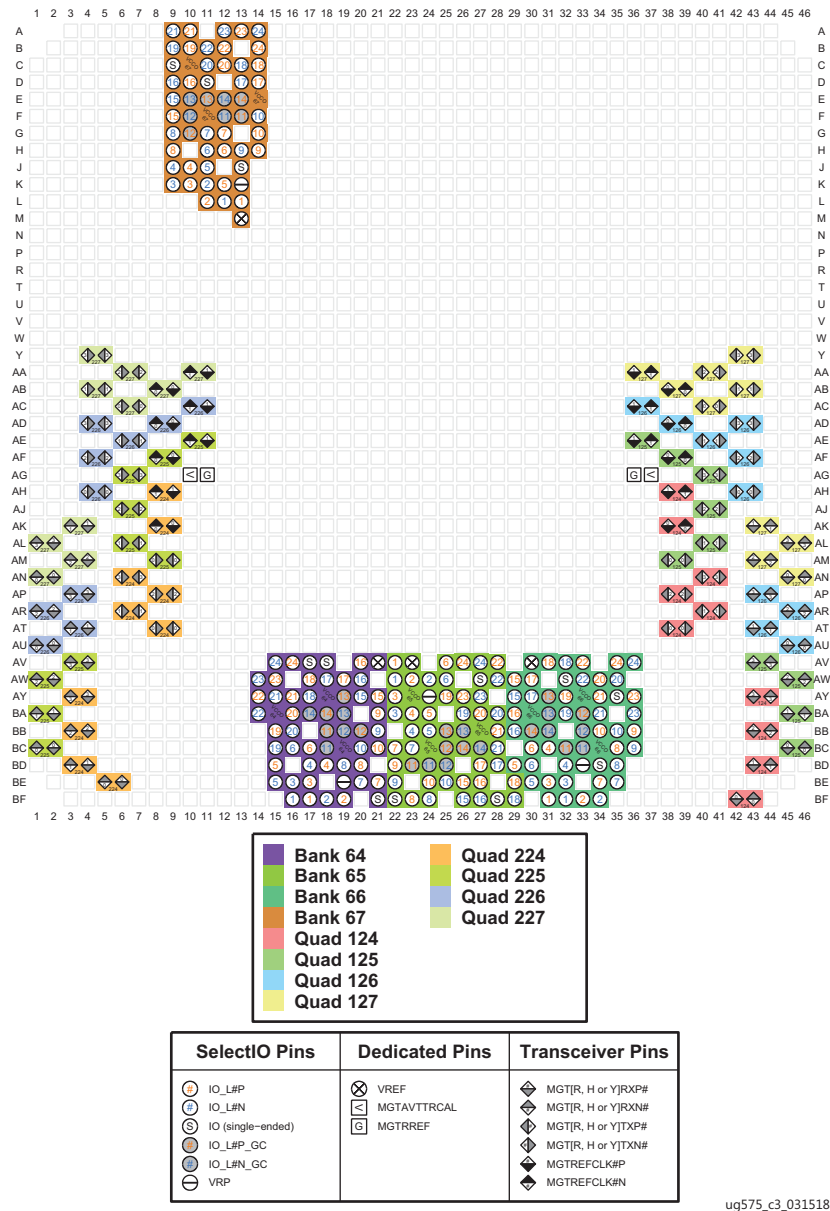
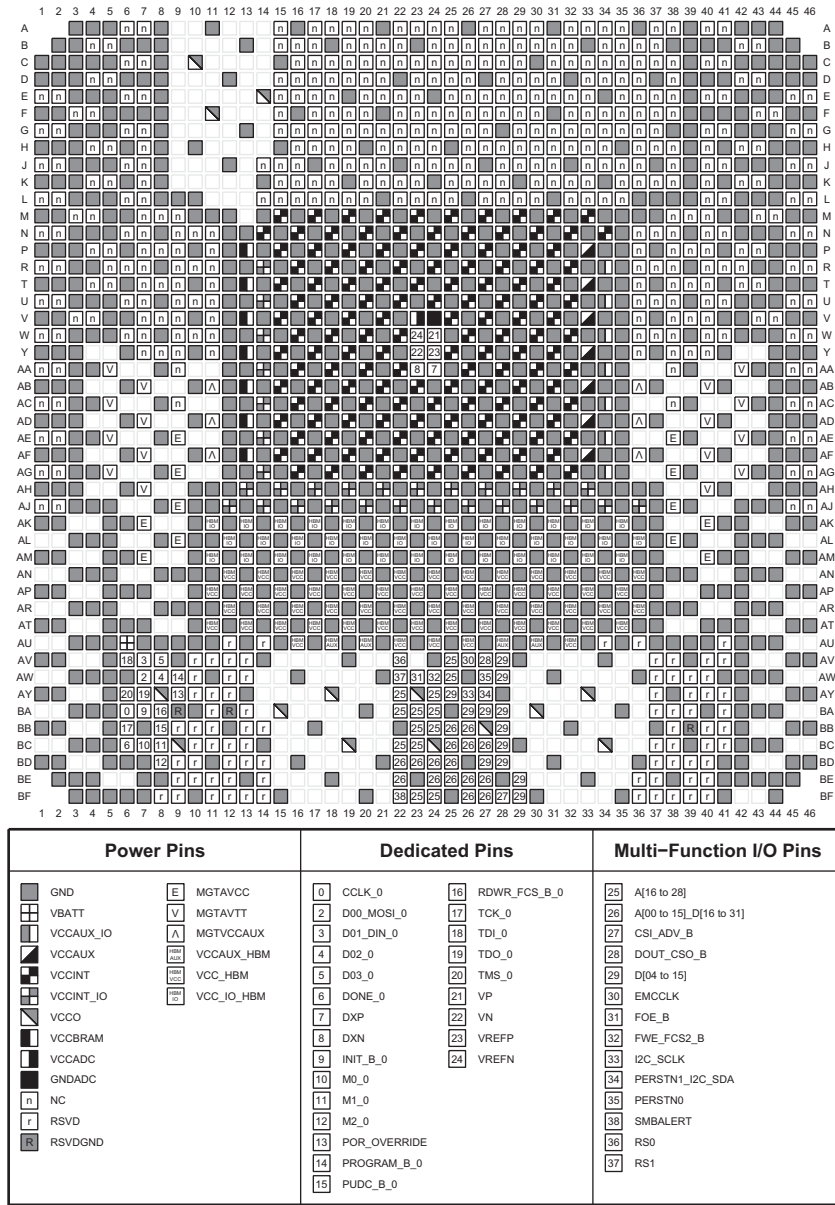

Figure 3-141: FSVH2104 Package—XCVU33P I/O Bank Diagram



ug575_c3_031518

Figure 3-142: FSVH2104 Package—XCVU33P Configuration/Power Diagram

FSVH2104 (XCVU35P)

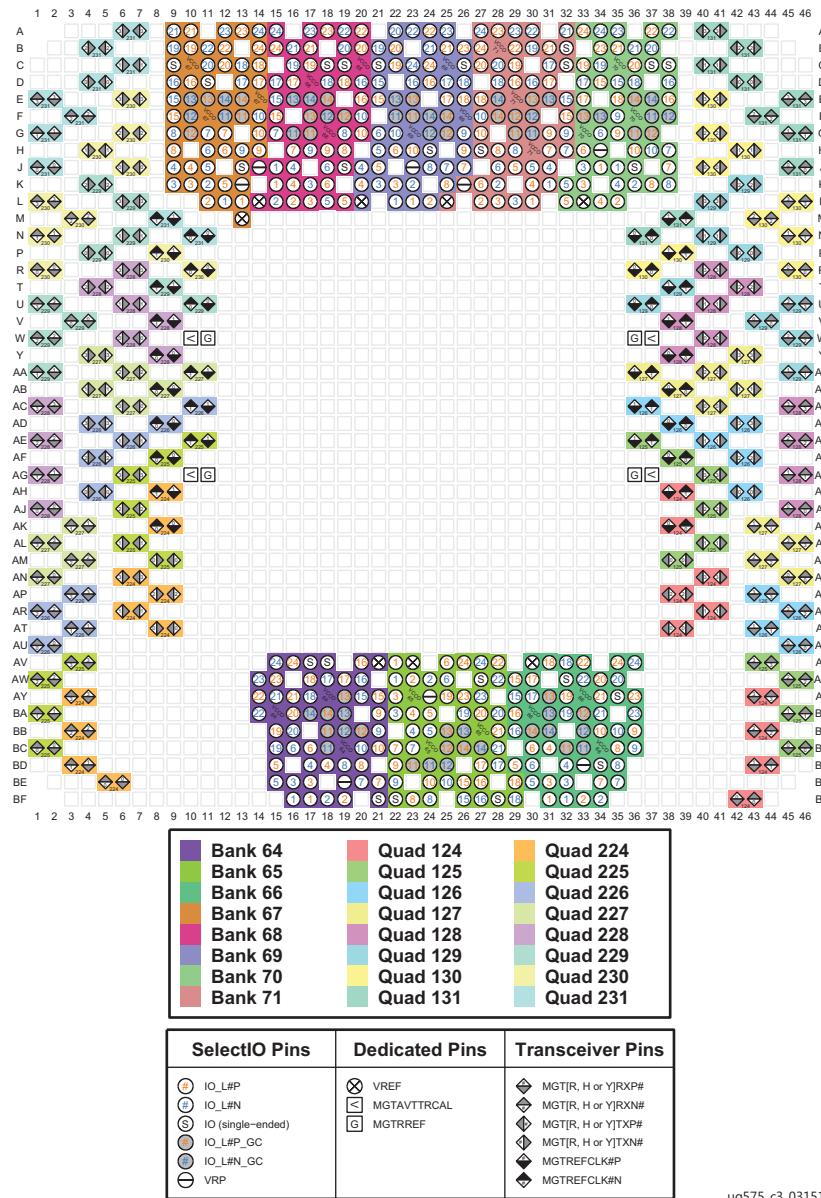
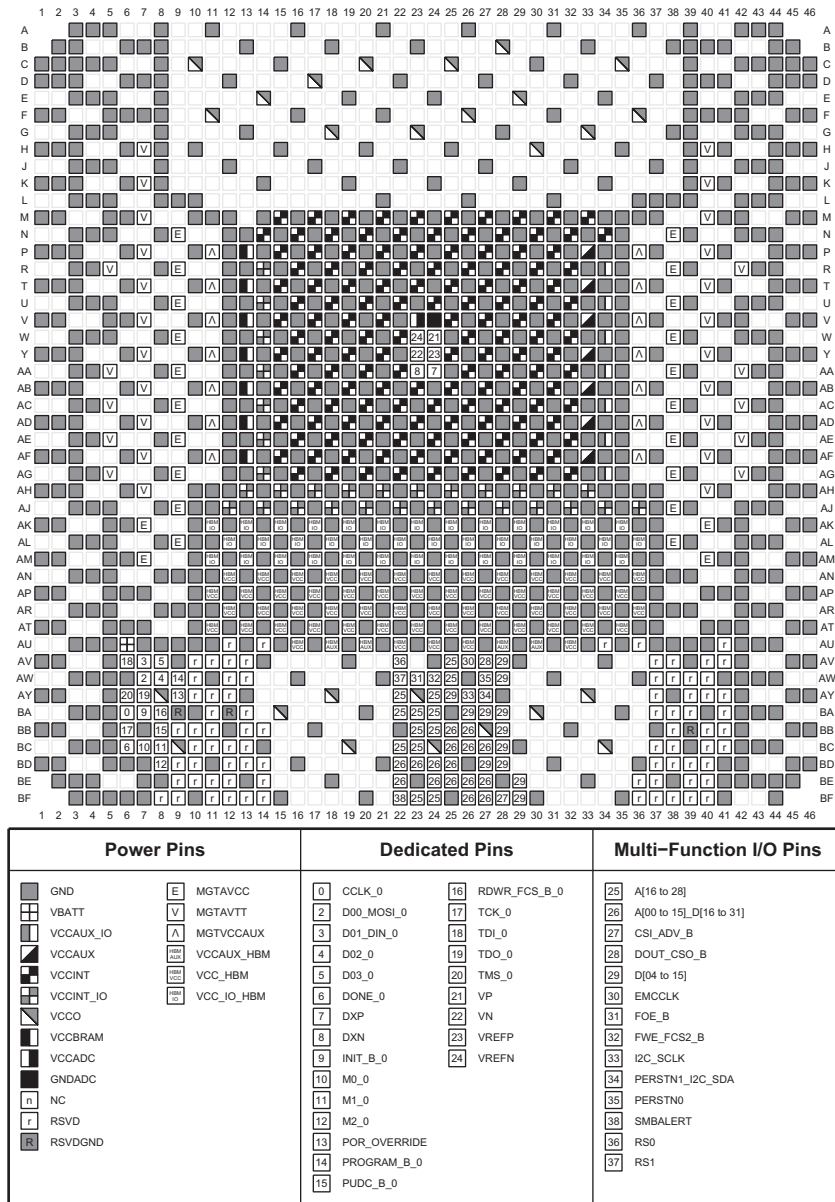

Figure 3-143: FSVH2104 Package—XCVU35P I/O Bank Diagram



ug575_c3_031518

Figure 3-144: FSVH2104 Package—XC7VU35P Configuration/Power Diagram

FLGA2577 (XCVU9P)

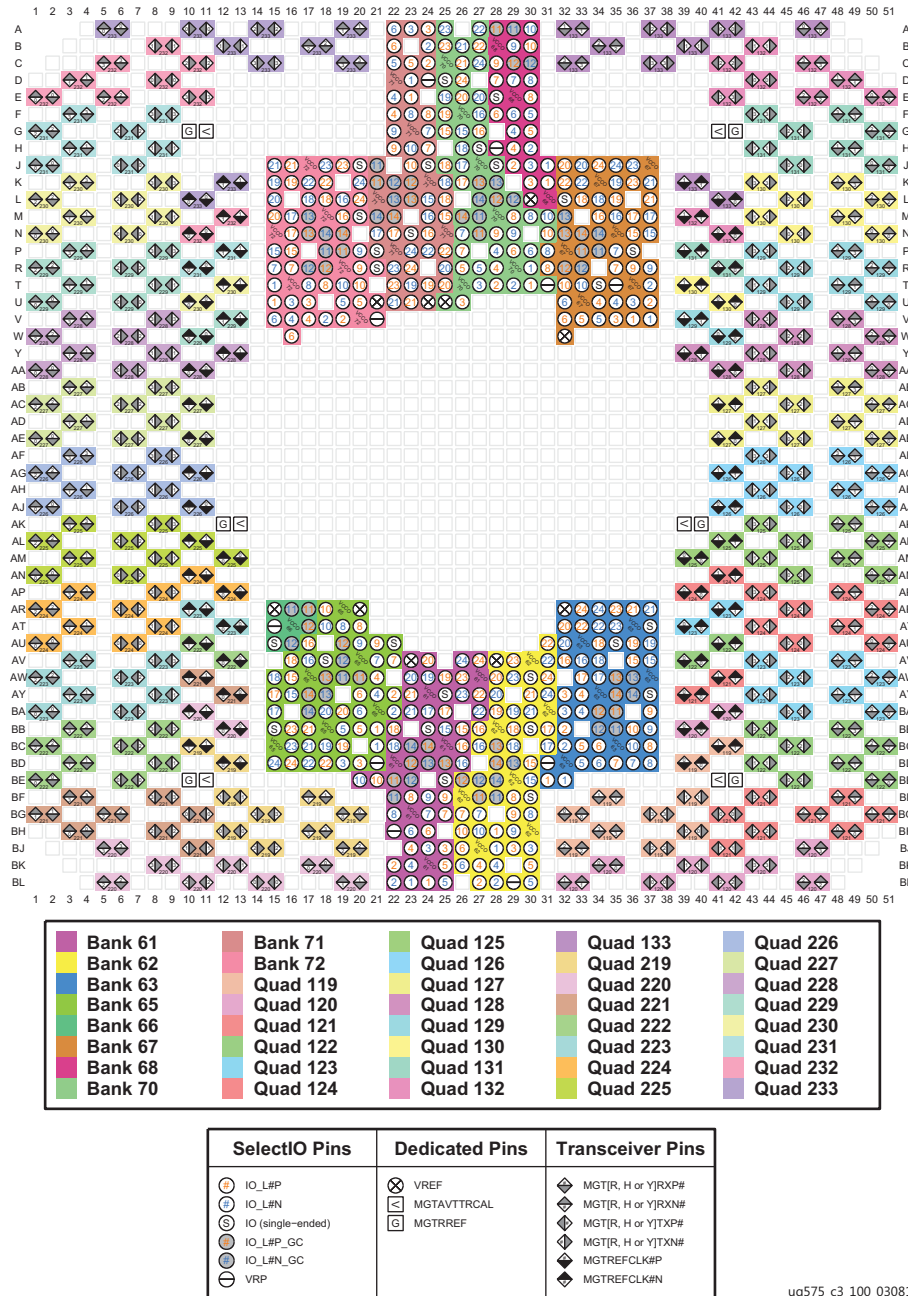
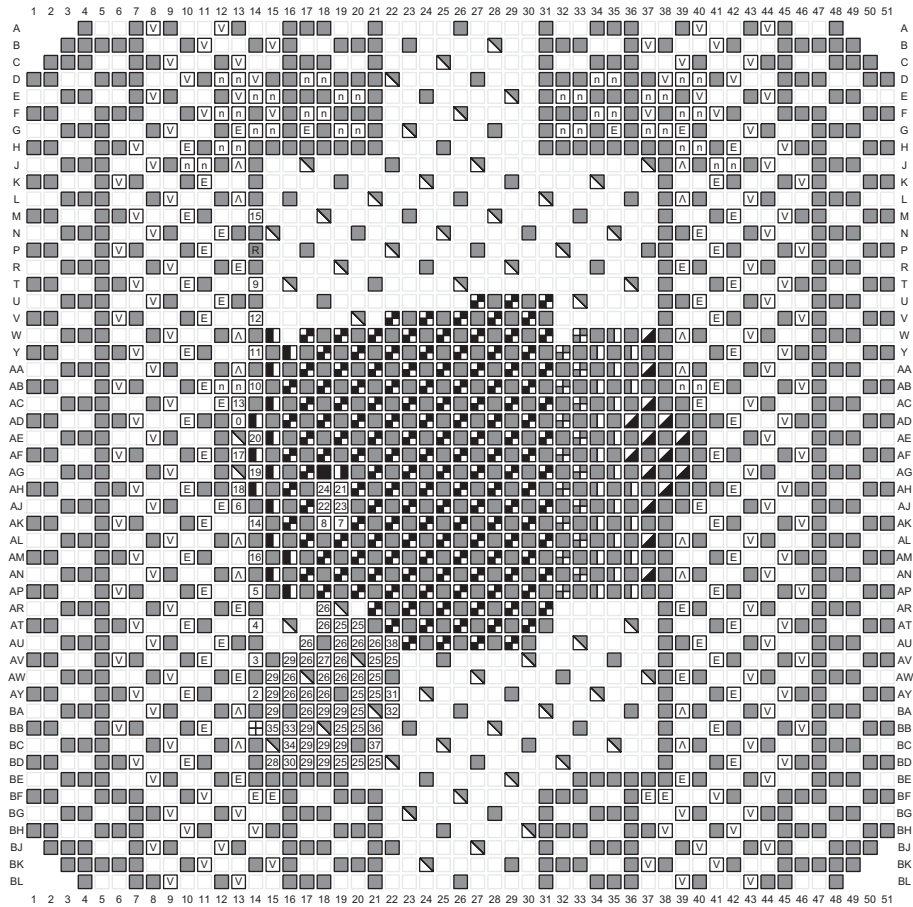

Figure 3-145: FLGA2577 Package—XCVU9P I/O Bank Diagram



Power Pins	Dedicated Pins	Multi-Function I/O Pins
GND	0 CCLK_0	25 A[16 to 28]
VBATT	2 D00_MOSI_0	26 A[00 to 15]_D[16 to 31]
VCCAUX_IO	3 D01_DIN_0	27 CSI_ADV_B
VCCAUX	4 D02_0	28 DOUT_CSO_B
VCCINT	5 D03_0	29 D[04 to 15]
VCCINT_IO	6 DONE_0	30 EMCCLK
VCCO	7 DXP	31 FOE_B
VCCBRAM	8 DXN	32 FWE_FCS2_B
VCCADC	9 INIT_B_0	33 I2C_SCLK
GNDADC	10 M0_0	34 PERSTN1_I2C_SDA
NC	11 M1_0	35 PERSTN0
MGTAVCC	12 M2_0	38 SMBALERT
MGTAVTT	13 POR_OVERRIDE	36 RSO
MGTVCCAUX	14 PROGRAM_B_0	37 RS1
RSVDGND	15 PUDC_B_0	
	16 RDWR_FCS_B_0	
	17 TCK_0	
	18 TDI_0	
	19 TDO_0	
	20 TMS_0	
	21 VP	
	22 VN	
	23 VREFP	
	24 VREFN	

ug575_c3_100_030817

Figure 3-146: FLGA2577 Package—XCVU9P Configuration/Power Diagram

FLGA2577 (XCVU11P)

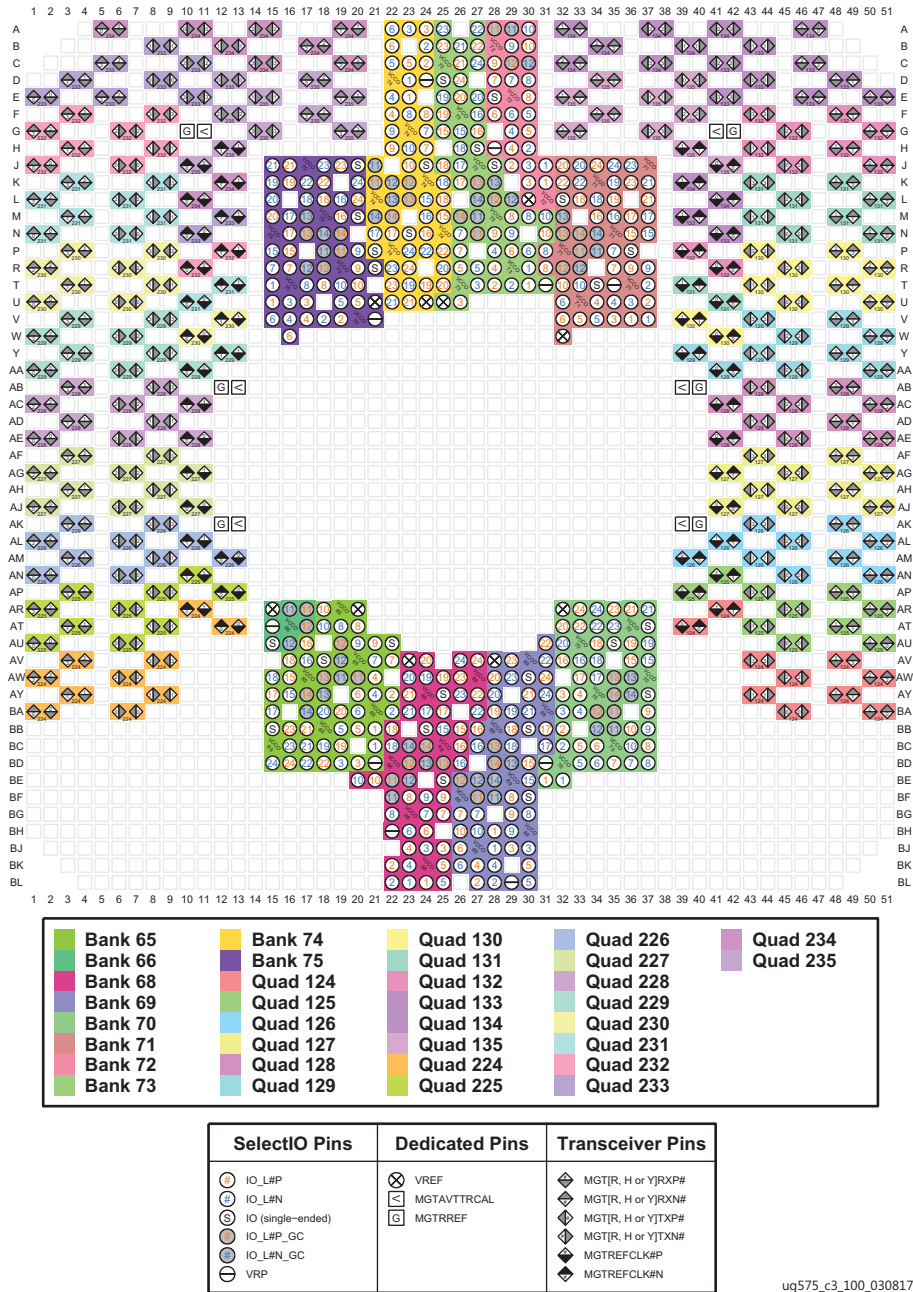
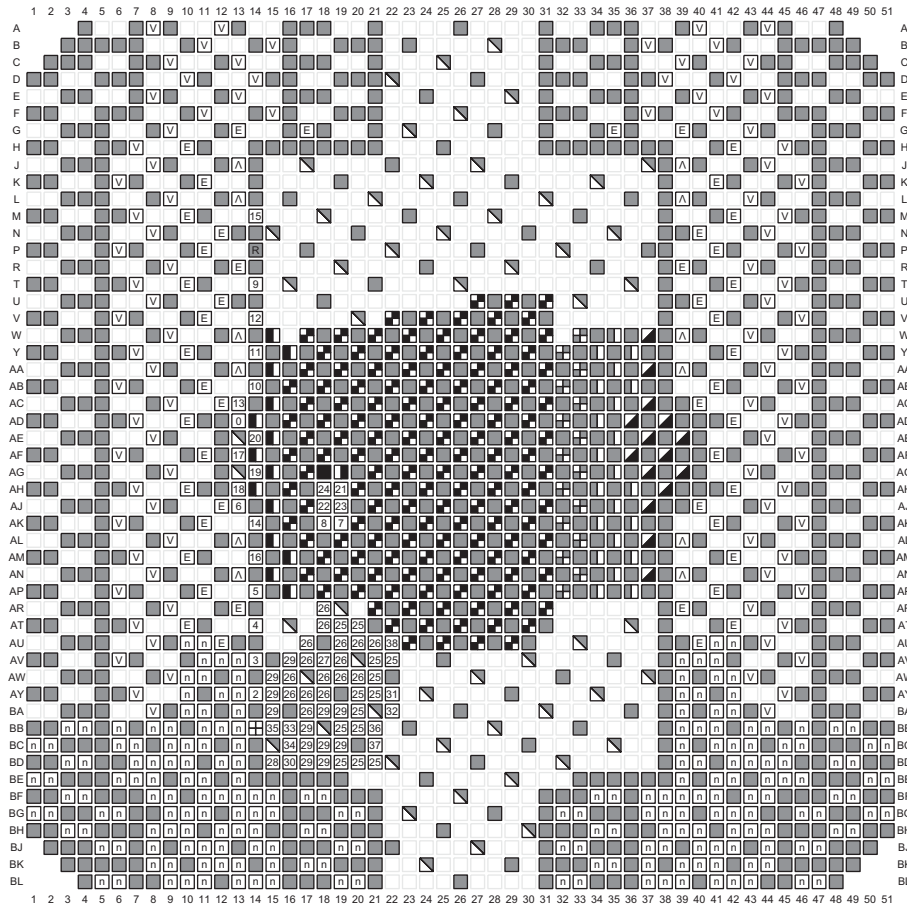

Figure 3-147: FLGA2577 Package—XCVU11P I/O Bank Diagram



Power Pins	Dedicated Pins	Multi-Function I/O Pins
GND	0 CCLK_0	25 A[16 to 28]
VBATT	2 D00_MOSI_0	26 A[00 to 15]_D[16 to 31]
VCCAUX_IO	3 D01_DIN_0	27 CSI_ADV_B
VCCAUX	4 D02_0	28 DOUT_CSO_B
VCCINT	5 D03_0	29 D[04 to 15]
VCCINT_IO	6 DONE_0	30 EMCCLK
VCCO	7 DXP	31 FOE_B
VCCBRAM	8 DXN	32 FWE_FCS2_B
VCCADC	9 INIT_B_0	33 I2C_SCLK
GNDADC	10 M0_0	34 PERSTN1_I2C_SDA
NC	11 M1_0	35 PERSTN0
MGTAVCC	12 M2_0	38 SMBALERT
MGTAVTT	13 POR_OVERRIDE	36 RSO
MGTVCCAUX	14 PROGRAM_B_0	37 RS1
RSVDGND	15 PUDC_B_0	
	16 RDWR_FCS_B_0	
	17 TCK_0	
	18 TDI_0	
	19 TDO_0	
	20 TMS_0	
	21 VP	
	22 VN	
	23 VREFP	
	24 VREFN	

ug575_c3_100_030817

Figure 3-148: FLGA2577 Package—XCVU11P Configuration/Power Diagram

FLGA2577 and FSGA2577 (XCVU13P)

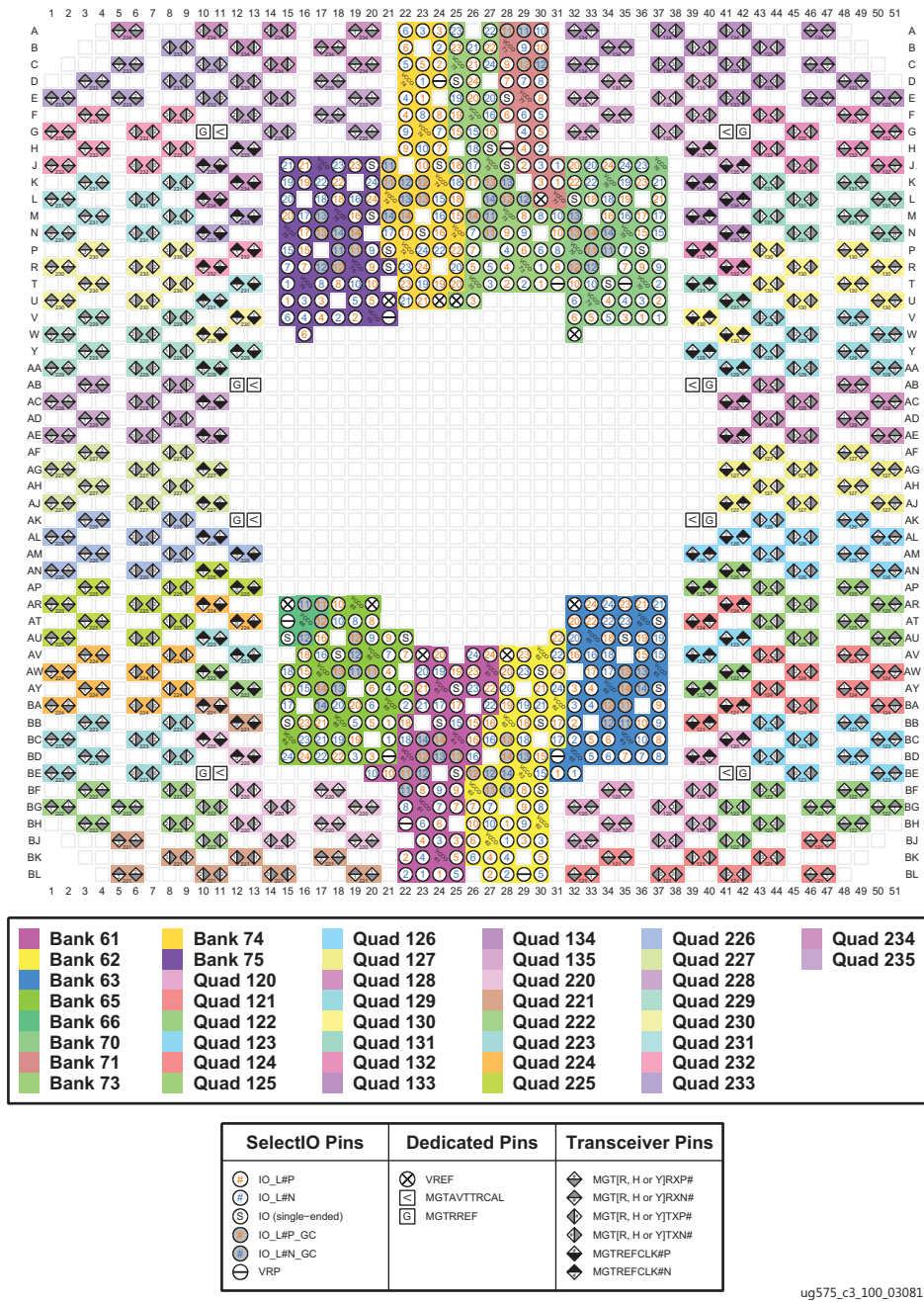

ug575_c3_100_030817

Figure 3-149: FLGA2577 and FSGA2577 Packages—XCVU13P I/O Bank Diagram

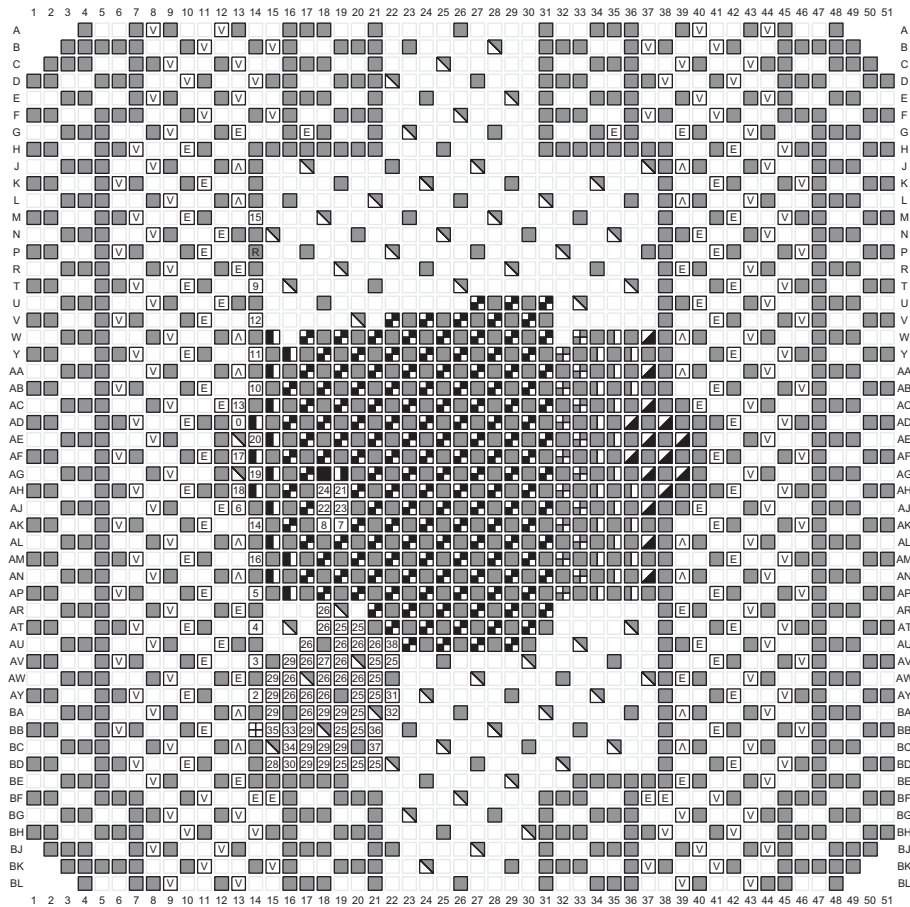

Power Pins	Dedicated Pins	Multi-Function I/O Pins
GND	0 CCLK_0	25 A[16 to 28]
VBATT	2 D00_MOSI_0	26 A[00 to 15]_D[16 to 31]
VCCAUX_IO	3 D01_DIN_0	27 CSI_ADV_B
VCCAUX	4 D02_0	28 DOUT_CSO_B
VCCINT	5 D03_0	29 D[04 to 15]
VCCINT_IO	6 DONE_0	30 EMCCLK
VCCO	7 DXP	31 FOE_B
VCCBRAM	8 DXN	32 FWE_FCS2_B
VCCADC	9 INIT_B_0	33 I2C_SCLK
GNDADC	10 M0_0	34 PERSTN1_I2C_SDA
NC	11 M1_0	35 PERSTN0
MGTAVCC	12 M2_0	36 SMBALERT
MGTAVTT	13 POR_OVERRIDE	37 RSO
MGTVCCAUX	14 PROGRAM_B_0	RS1
RSVDGND	15 PUDC_B_0	
	16 RDWR_FCS_B_0	
	17 TCK_0	
	18 TDI_0	
	19 TDO_0	
	20 TMS_0	
	21 VP	
	22 VN	
	23 VREFP	
	24 VREFN	

ug575_c3_100_030817

Figure 3-150: FLGA2577 and FSGA2577 Packages—XCVU13P Configuration/Power Diagram

FSGA2577 (XCVU27P)

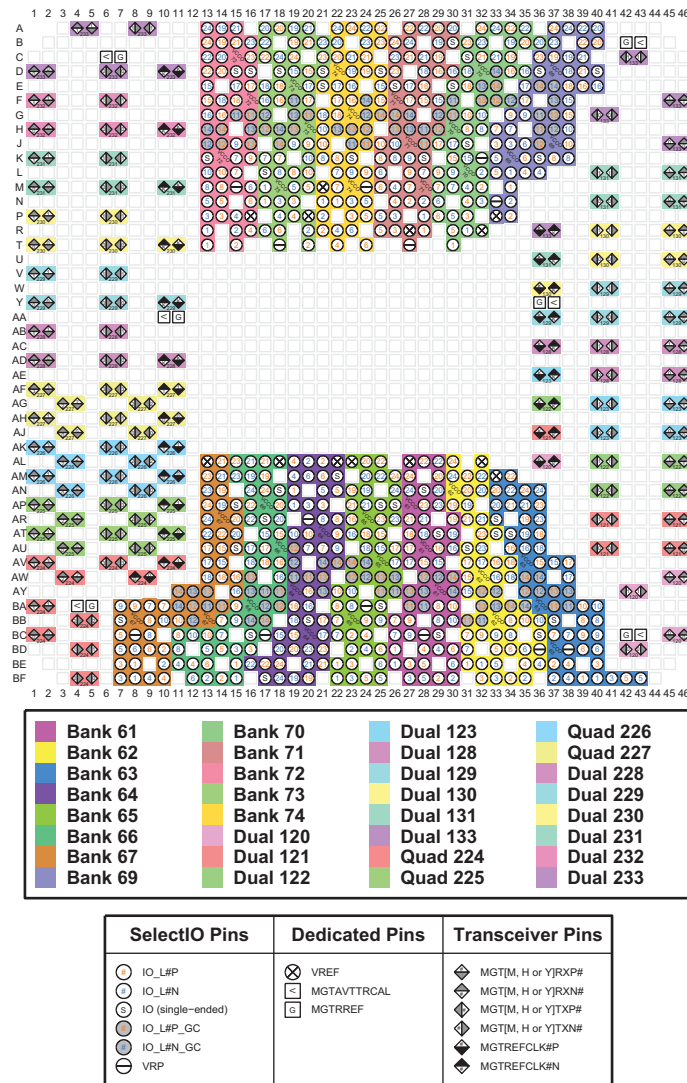

ug575_c3_xcvu27pfigd2104_010819

Figure 3-151: FSGA2577 Package—XCVU27P I/O Bank Diagram

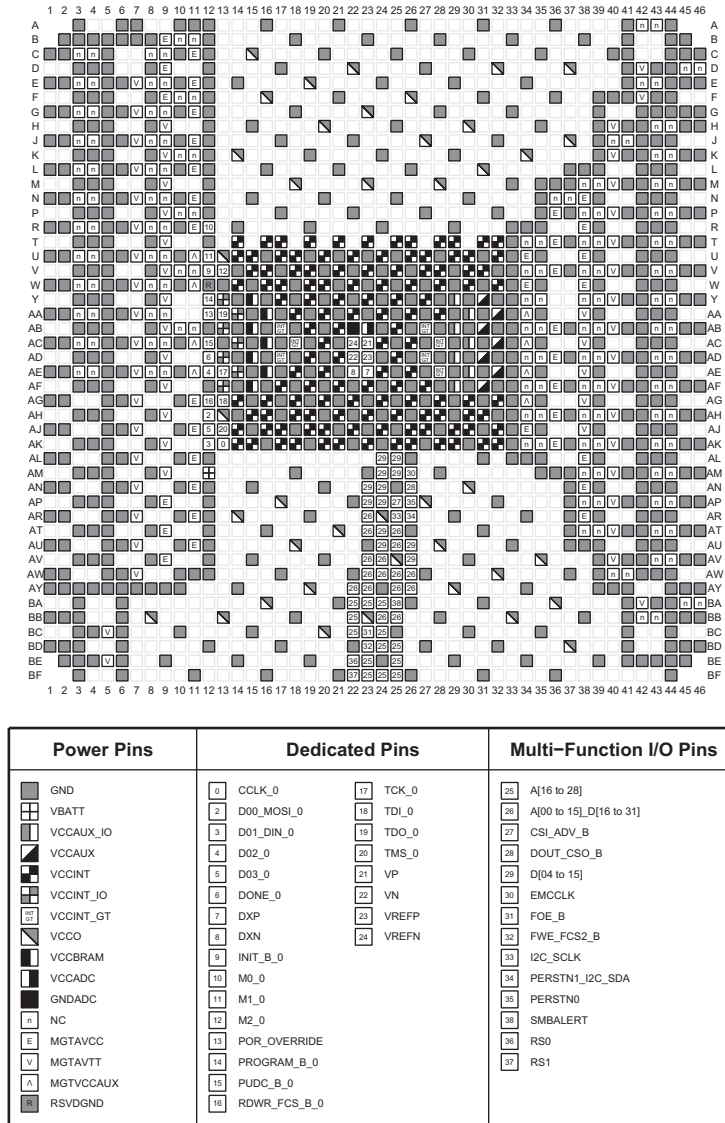

ug575_c3_xcvu27pfigd2104_010819

Figure 3-152: FSGA2577 Package—XCVU27P Configuration/Power Diagram

FSGA2577 (XCVU29P)

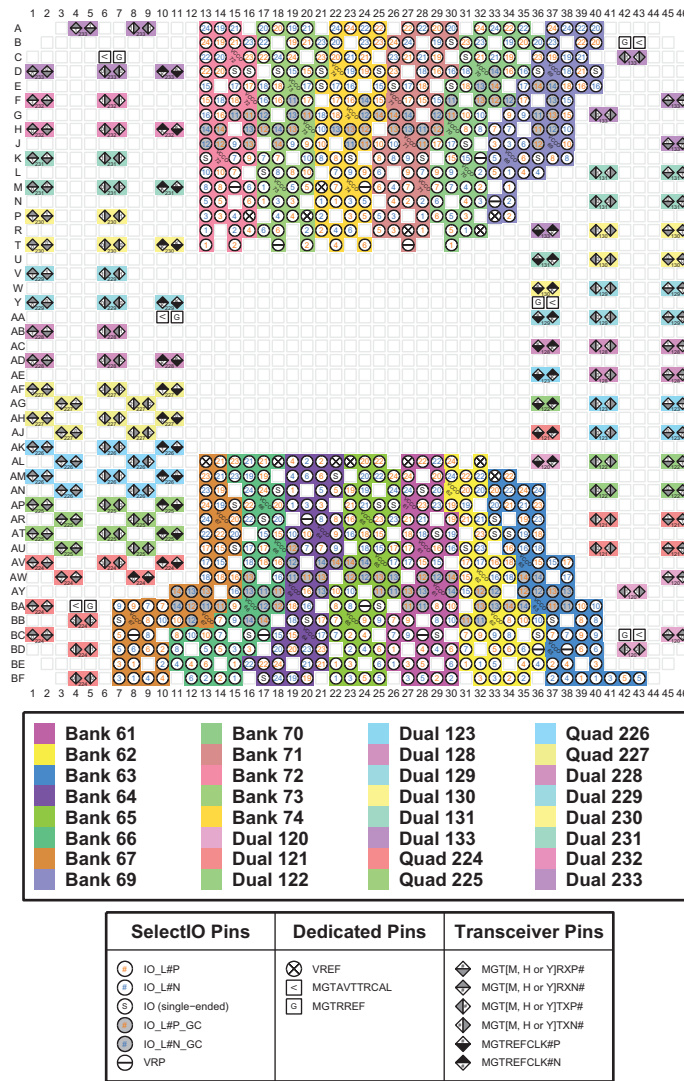

Figure 3-153: FSGA2577 Package—XCVU29P I/O Bank Diagram

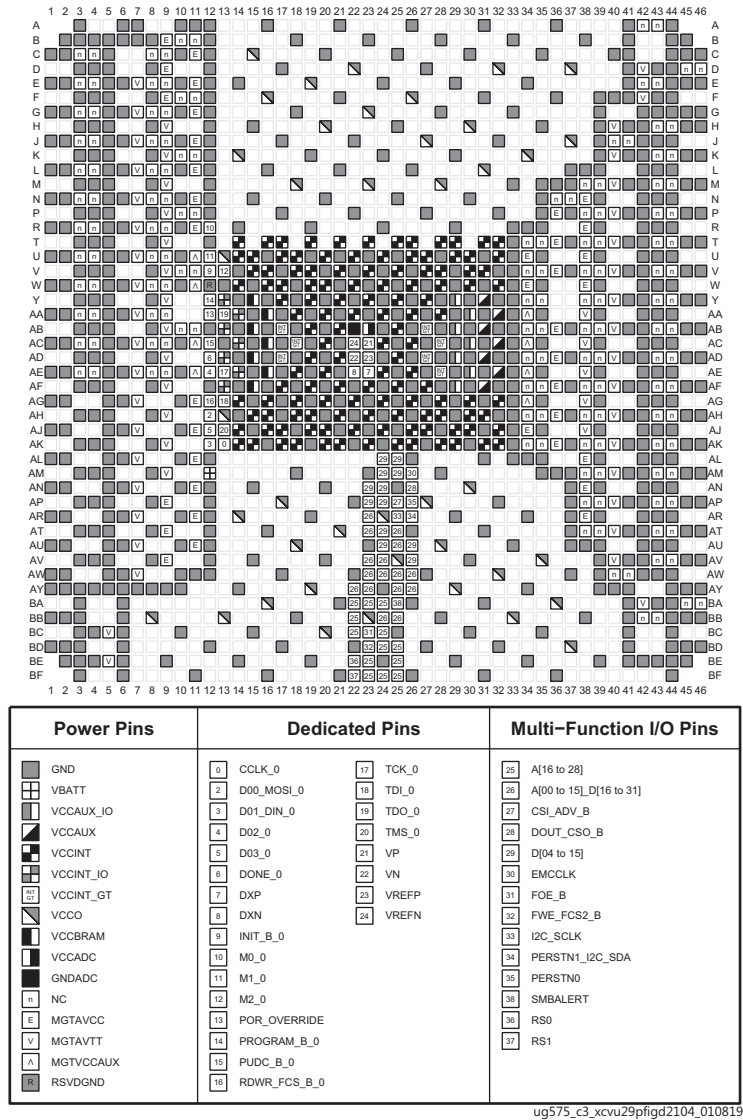
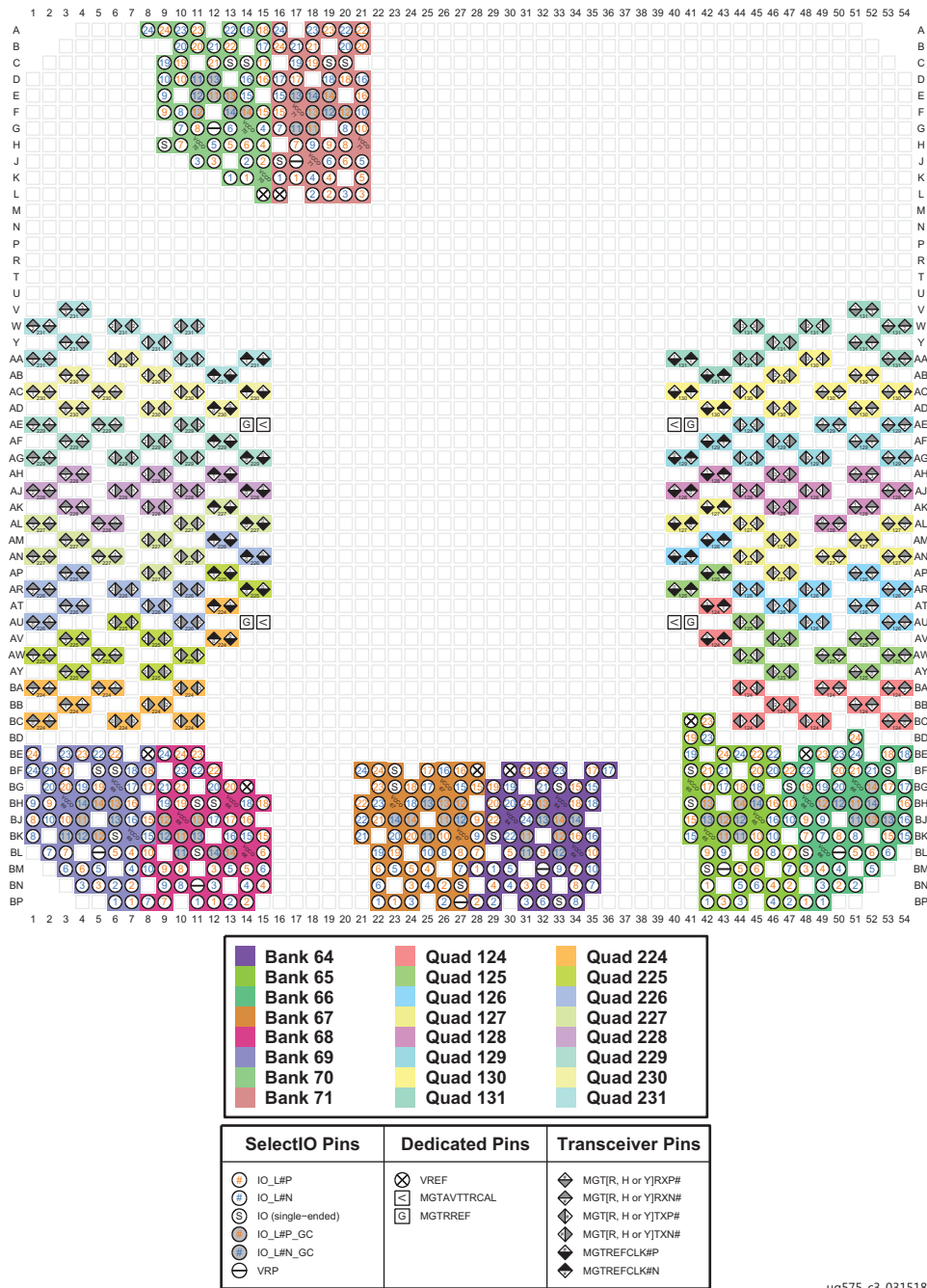

Figure 3-154: FSGA2577 Package—XCVU29P Configuration/Power Diagram

FSVH2892 (XCVU35P)



ug575_c3_031518

Figure 3-155: FSVH2892 Package—XCVU35P I/O Bank Diagram

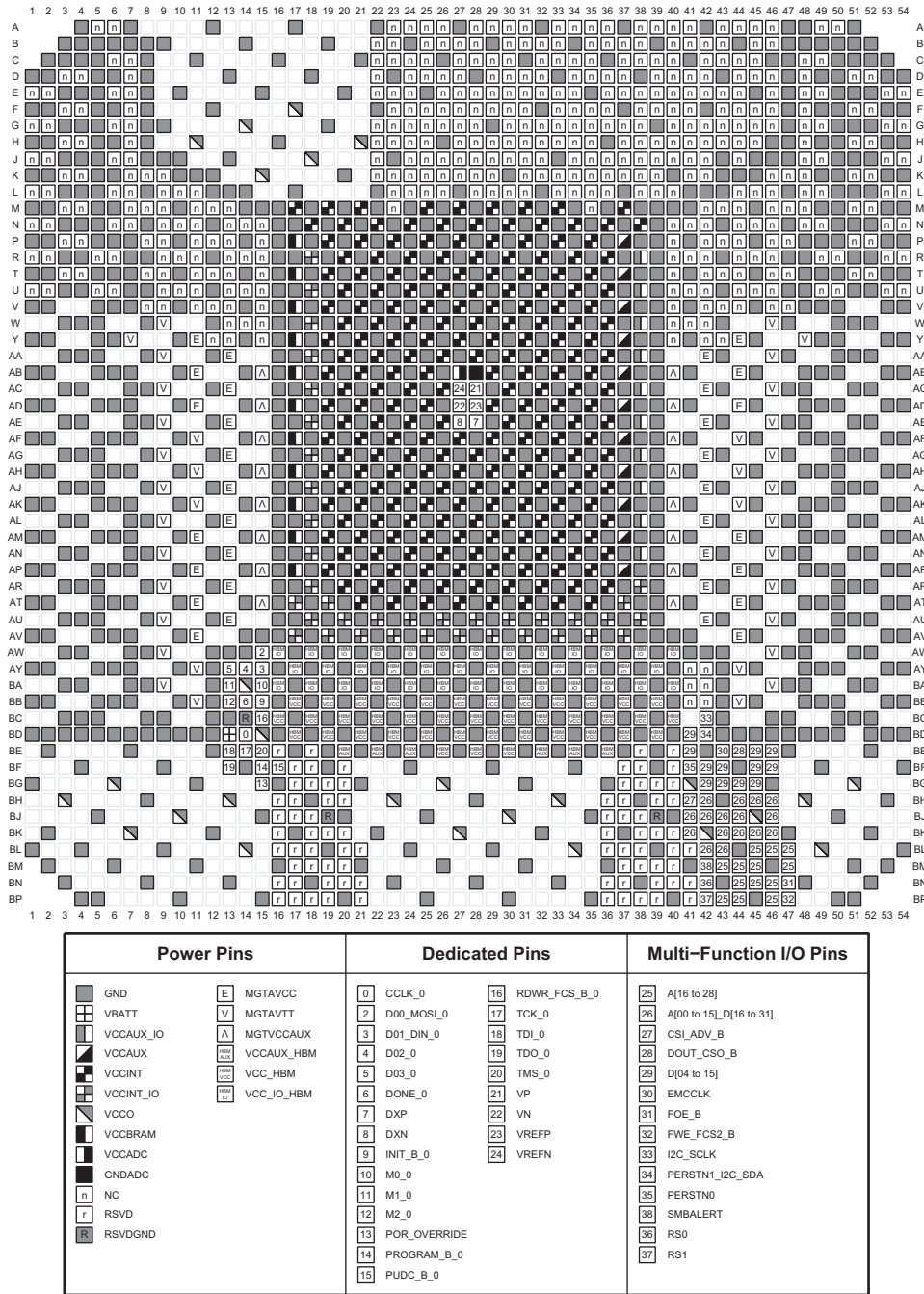

ug575_c3_031518

Figure 3-156: FSVH2892 Package—XCVU35P Configuration/Power Diagram

FSVH2892 (XCVU37P)

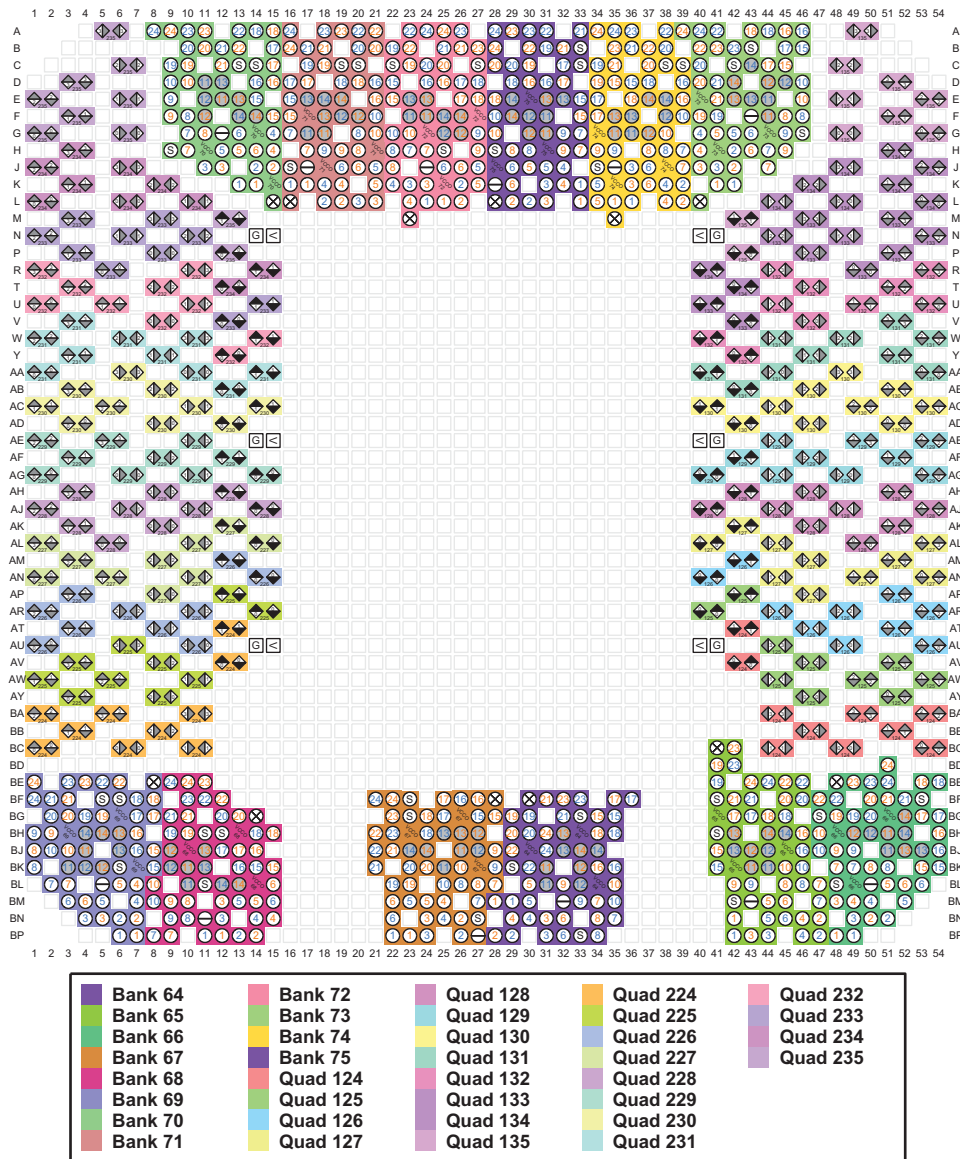

ug575_c3_110317

Figure 3-157: FSVH2892 Package—XCVU37P I/O Bank Diagram

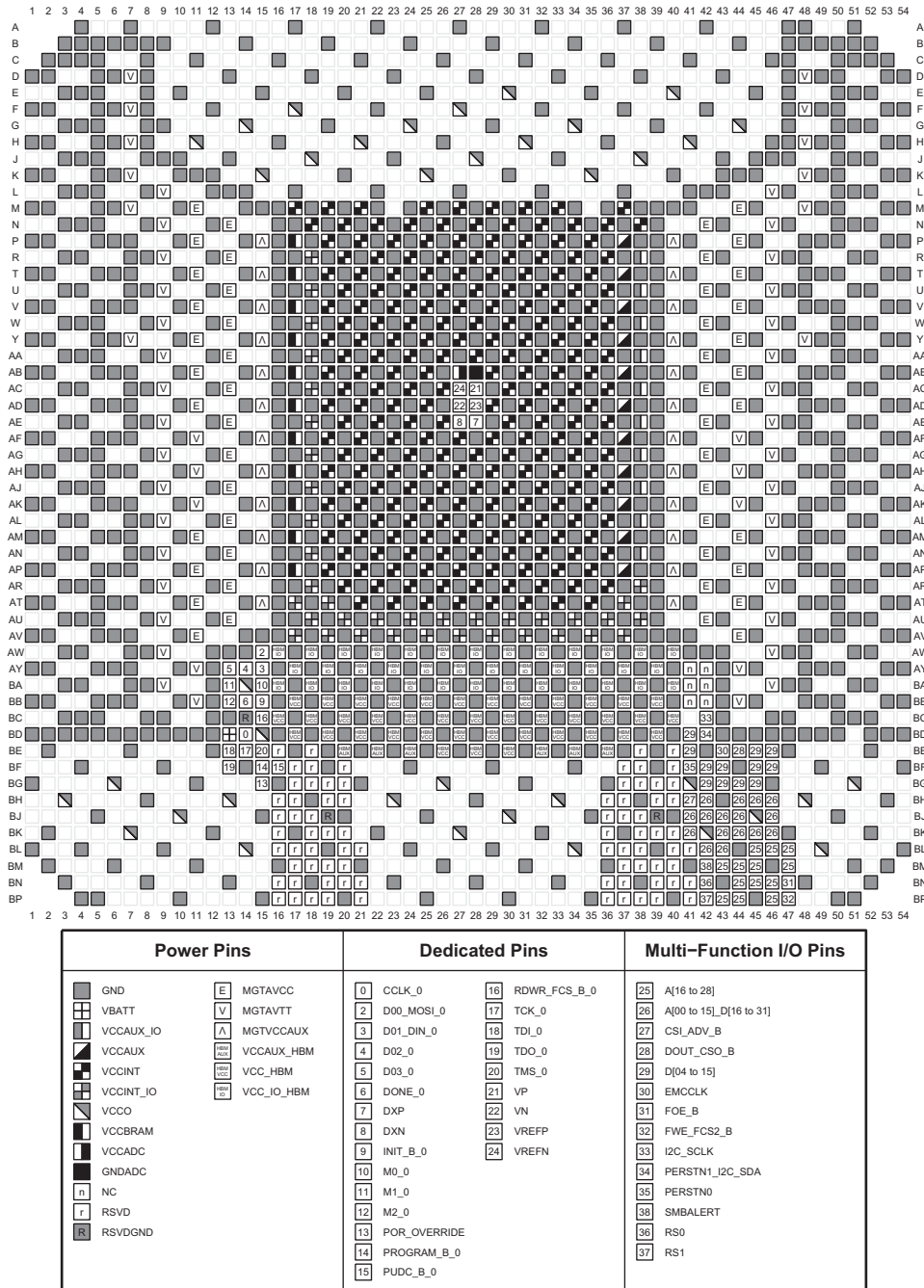

Figure 3-158: FSVH2892 Package—XCVU37P Configuration/Power Diagram

Mechanical Drawings

Summary

This chapter provides mechanical drawings (package specifications) of the UltraScale and UltraScale+ device packages. [Table 4-1](#) is a cross-reference to the mechanical drawings by device and package combination.

All Kintex and Virtex UltraScale+ devices are available in packages with eutectic BGA balls. To order these packages, the device type starts with an XQ vs. XC and the third digit in the package name replaces the V or G with a Q to delineate the use of eutectic balls on an otherwise XC package. For information on ordering the XQ non-ruggedized eutectic Sn/Pb ball packages, see the XQ UltraScale+ FPGA Ordering Information in the *XQ UltraScale Architecture Data Sheet Overview* (DS895) [[Ref 2](#)]. For the XQ non-ruggedized eutectic Sn/Pb ball packages mechanicals, refer to the XC packages in [Table 4-1](#) because they are built with an XC style package and lid using Pb-free solder inside.

In [Table 4-1](#), the full Defense-grade XQ ruggedized packages are delineated by an R in the third digit of the package code.

Table 4-1: Cross-Reference to Mechanical Drawings by Package

Package	Figure	Device			Package Status
FBVA676	Figure 4-1 Figure 4-2	XCKU035	XCKU040		Production
FFVA676 FFQA676	Figure 4-3	XCKU3P	XCKU5P		Production
FFVB676 FFQB676	Figure 4-3	XCKU3P	XCKU5P		Production
FFRB676	Figure 4-4	XQKU5P			Production
RBA676	Figure 4-5	XQKU040			Production
SFVA784	Figure 4-6	XCKU035	XCKU040		Production
SFVB784 SFQB784	Figure 4-7	XCKU3P	XCKU5P		Production
SFRB784	Figure 4-8	XQKU5P			Production

Table 4-1: Cross-Reference to Mechanical Drawings by Package (Cont'd)

Package	Figure	Device				Package Status
FBVA900	Figure 4-9 Figure 4-10	XCKU035	XCKU040			Production
FFVD900 FFQD900	Figure 4-11	XCKU3P	XCKU5P	XCKU11P		Production
FFVE900 FFQE900	Figure 4-11	XCKU9P	XCKU13P			Production
FFVA1156 FFQA1156 ⁽¹⁾	Figure 4-12	XCKU025	XCKU035	XCKU040		Production
	Figure 4-13	XCKU060	XCKU095	XCKU11P		Production
	Figure 4-14	XCKU15P				Production
FFRA1156	Figure 4-15	XQKU15P				Production
RFA1156	Figure 4-16	XQKU040				Production
	Figure 4-17	XQKU060	XQKU095			Production
FFVA1517	Figure 4-18	XCKU060				Production
FLVA1517	Figure 4-21	XCKU085	XCKU115			Production
FFVC1517	Figure 4-18	XCKU095	XCVU065	XCVU080	XCVU095	Production
FFQC1517 ⁽¹⁾	Figure 4-19	XCVU3P				Production
FFRC1517	Figure 4-20	XQVU3P				Production
FFVD1517	Figure 4-18	XCVU080	XCVU095			Production
FLVD1517	Figure 4-21	XCKU115	XCVU125			Production
FFVE1517 FFQE1517	Figure 4-19	XCKU11P	XCKU15P			Production
FFRE1517	Figure 4-20	XQKU15P				Production
RLD1517	Figure 4-22	XQKU115				Production
FFVA1760 FFQA1760	Figure 4-23	XCKU15P				Production
FFVB1760	Figure 4-24	XCKU095	XCVU080	XCVU095		Production
FLVB1760	Figure 4-25	XCKU085	XCKU115	XCVU125		Production
FFVE1760 FFQE1760	Figure 4-26	XCKU15P				Production
FLVD1924	Figure 4-27	XCKU115				Production
FLVF1924	Figure 4-27	XCKU085	XCKU115			Production
FLGF1924 FLQF1924	Figure 4-28	XCVU11P				Production
RLF1924	Figure 4-29	XQKU115				Production
FSVH1924 FSQH1924	Figure 4-30	XCVU31P				Production
FFVA2104	Figure 4-31	XCVU080	XCVU095			Production

Table 4-1: Cross-Reference to Mechanical Drawings by Package (Cont'd)

Package	Figure	Device			Package Status
FHGA2104 FHQA2104	Figure 4-32	XCVU13P			Production
FLVA2104	Figure 4-34	XCKU115	XCVU125		Production
FLQA2104 ⁽¹⁾	Figure 4-35	XCVU5P	XCVU7P		Production
FLRA2104	Figure 4-36	XQVU7P			Production
FLGA2104 FLQA2104	Figure 4-37	XCVU9P			Production
FFVB2104	Figure 4-31	XCKU095	XCVU080	XCVU095	Production
FHGB2104 FHQB2104	Figure 4-33	XCVU13P			Production
FLVB2104	Figure 4-34	XCKU115	XCVU125		Production
FLQB2104 ⁽¹⁾	Figure 4-35	XCVU5P	XCVU7P		Production
FLRB2104	Figure 4-36	XQVU7P			Production
FLGB2104	Figure 4-38	XCVU160	XCVU190		Production
FLQB2104 ⁽¹⁾	Figure 4-39	XCVU9P	XCVU11P		Production
FFVC2104	Figure 4-41	XCVU095			Production
FHGC2104 FHQC2104	Figure 4-33	XCVU13P			Production
FLGC2104 FLQC2104 ⁽¹⁾	Figure 4-38	XCVU160	XCVU190		Production
	Figure 4-42	XCVU9P			Production
	Figure 4-39	XCVU11P			Production
FLRC2104	Figure 4-40	XQVU11P			Production
FLVC2104	Figure 4-43	XCVU125			Production
FLQC2104 ⁽¹⁾	Figure 4-44	XCVU5P	XCVU7P		Production
FIGD2104	Figure 4-45	XCVU13P			Production
FIQD2104 ⁽¹⁾	Figure 4-45	XCVU27P	XCVU29P		Evaluation Only
FSGD2104 FSQD2104	Figure 4-46	XCVU9P			Production
	Figure 4-47	XCVU11P			Production
FSVH2104 FSQH2104	Figure 4-48	XCVU33P			Production
	Figure 4-49	XCVU35P			Production
FLGB2377	Figure 4-50	XCVU440			Production
FLGA2577 FLQA2577 ⁽¹⁾	Figure 4-51	XCVU190			Production
	Figure 4-52	XCVU9P	XCVU13P		Production
	Figure 4-53	XCVU11P			Production

Table 4-1: Cross-Reference to Mechanical Drawings by Package (Cont'd)

Package	Figure	Device		Package Status
FSGA2577	Figure 4-54	XCVU13P		Production
FSQA2577	Figure 4-54	XCVU27P	XCVU29P	Evaluation Only
FLGA2892	Figure 4-55	XCVU440		Production
FSVH2892	Figure 4-56	XCVU35P		Production
FSQH2892	Figure 4-57	XCVU37P		Production

Notes:

1. The XQ devices with non-ruggedized eutectic Sn/Pb ball packages are only available in Kintex and Virtex UltraScale+ devices.

FBVA676 Bare-die Flip-Chip, Fine-Pitch BGA (XCKU035 and XCKU040)

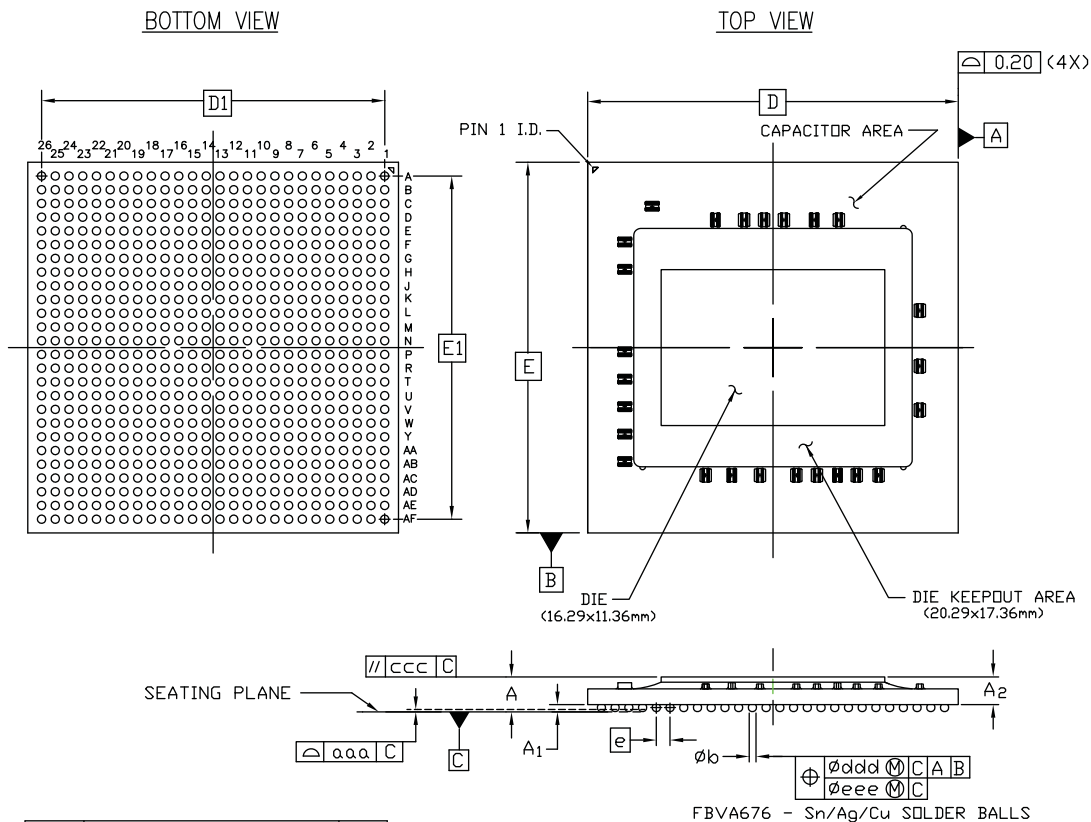

SYMBOL	MILLIMETERS			NOTE
	MIN.	NOM.	MAX.	
A	2.31	2.51	2.71	2
A ₁	0.40	0.50	0.60	
A ₂	1.81	2.01	2.21	
D/E	27.00 BASIC			
D ₁ /E ₁	25.00 BASIC			
e	1.00 BASIC			
phi _b	0.50	0.60	0.70	
aaa	<i>xx</i>	<i>xx</i>	0.20	
ccc	<i>xx</i>	<i>xx</i>	0.25	
ddd	<i>xx</i>	<i>xx</i>	0.25	
eee	<i>xx</i>	<i>xx</i>	0.10	
M	26			

NOTES:

1. ALL DIMENSIONS AND TOLERANCES CONFORM TO ANSI Y14.5M-1994
2. SYMBOL 'M' IS THE BALL MATRIX SIZE
3. CONFORMS TO JEDEC MS-034
4. SEE NEXT PAGE FOR CHIP CAPACITOR LOCATION DIMENSIONS

ug575_c4_01_082014

Figure 4-1: Package Dimensions for FBVA676 (XCKU035 and XCKU040)

CHIP CAPACITOR LAYOUT

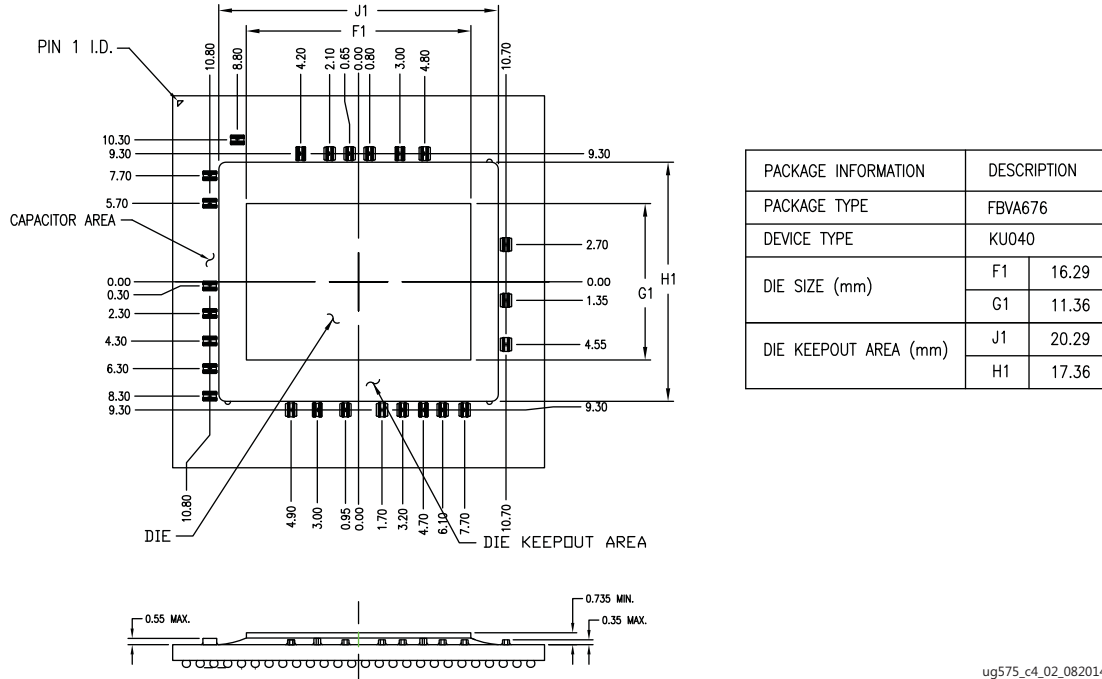

ug575_c4_02_082014

Figure 4-2: FBVA676 Package (XCKU035 and XCKU040) Die Dimensions with Capacitor Locations

FFVA676 and FFVB676 Flip-Chip, Fine-Pitch BGA (XCKU3P and XCKU5P)

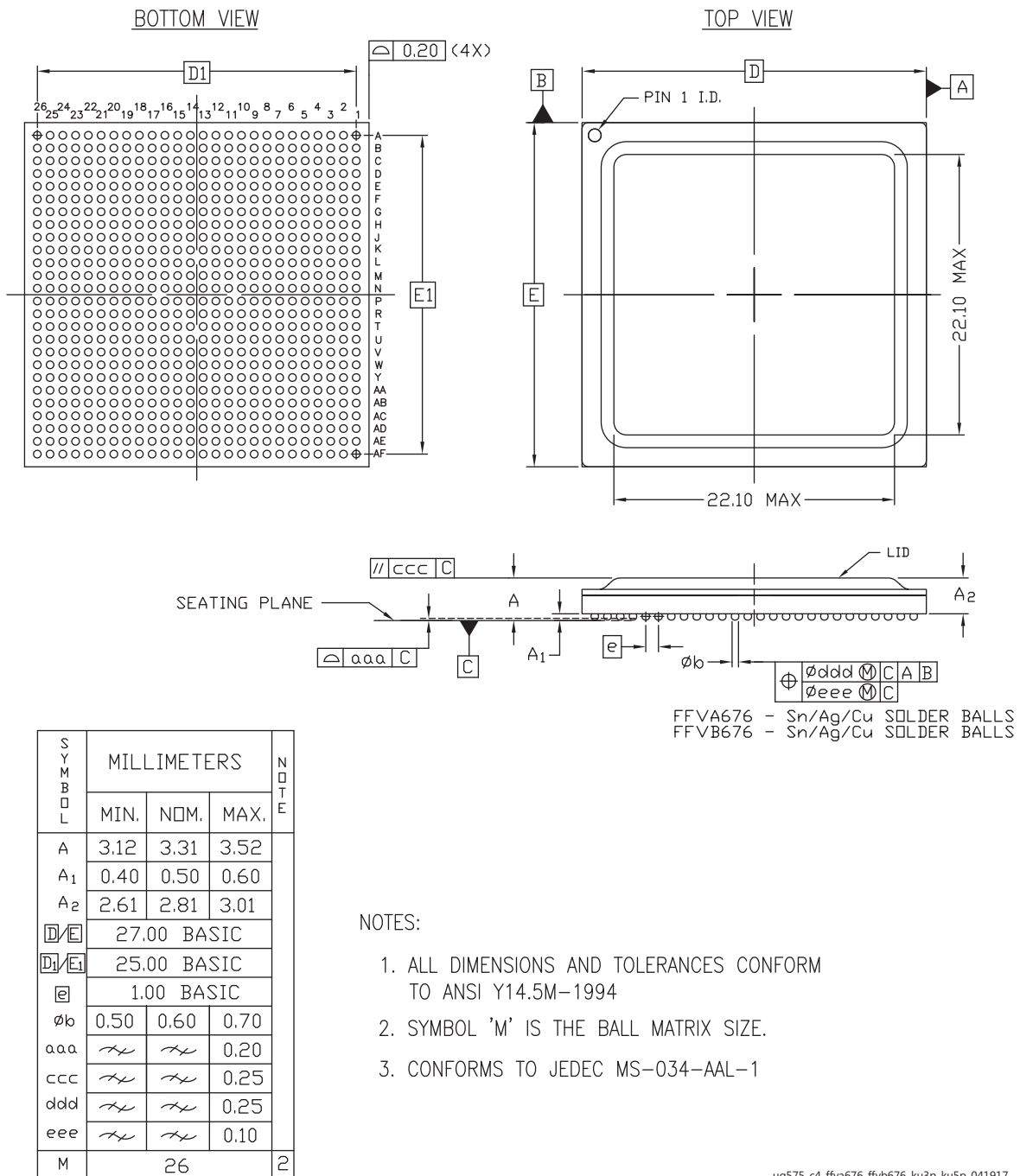

Figure 4-3: Package Dimensions for FFVA676 and FFVB676 (XCKU3P and XCKU5P)

FFRB676 Ruggedized Flip-Chip, Fine-Pitch BGA (XQKU5P)

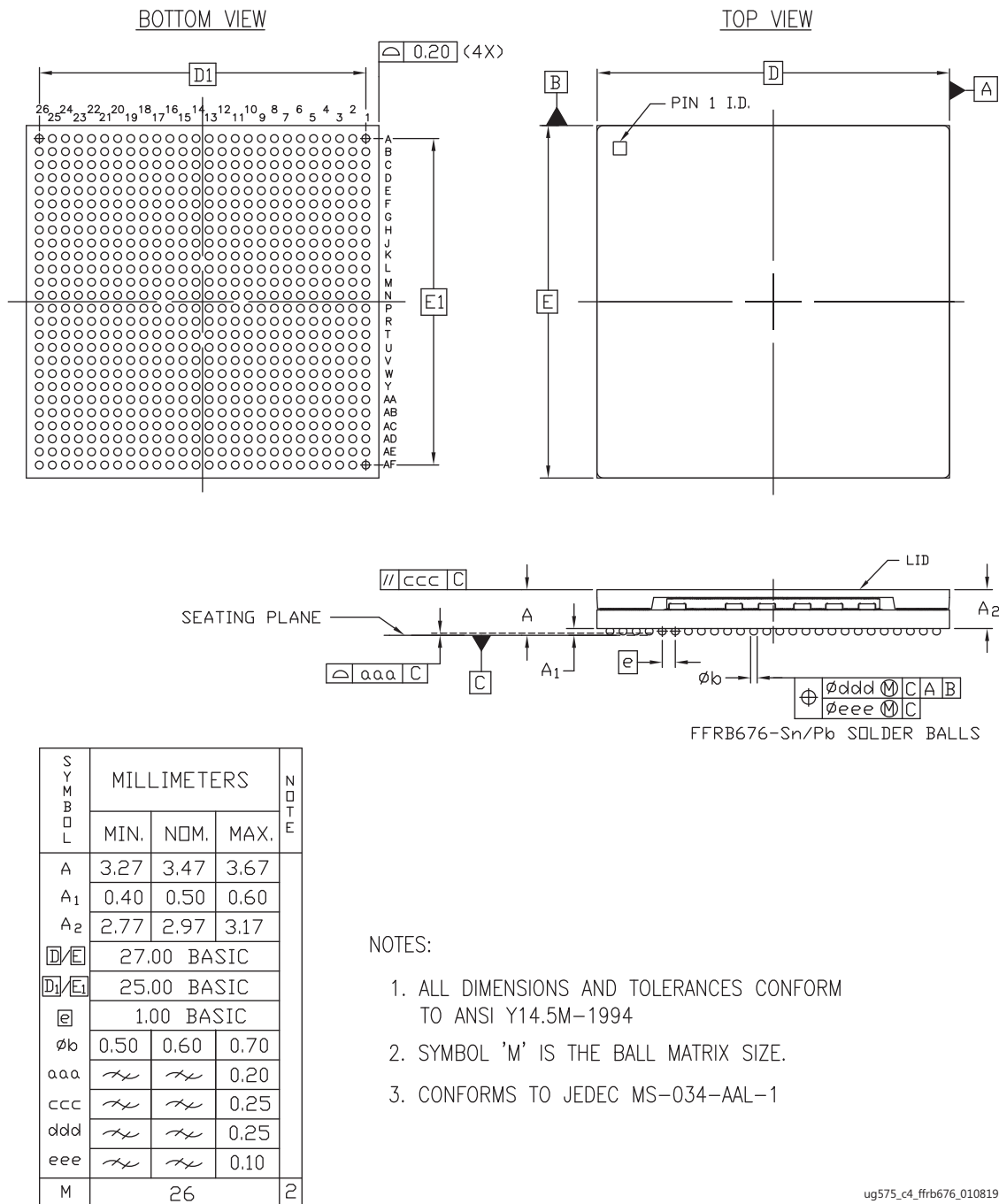

Figure 4-4: Package Dimensions for FFRB676 (XQKU5P)

RBA676 Ruggedized Flip-Chip, Fine-Pitch BGA (XQKU040)

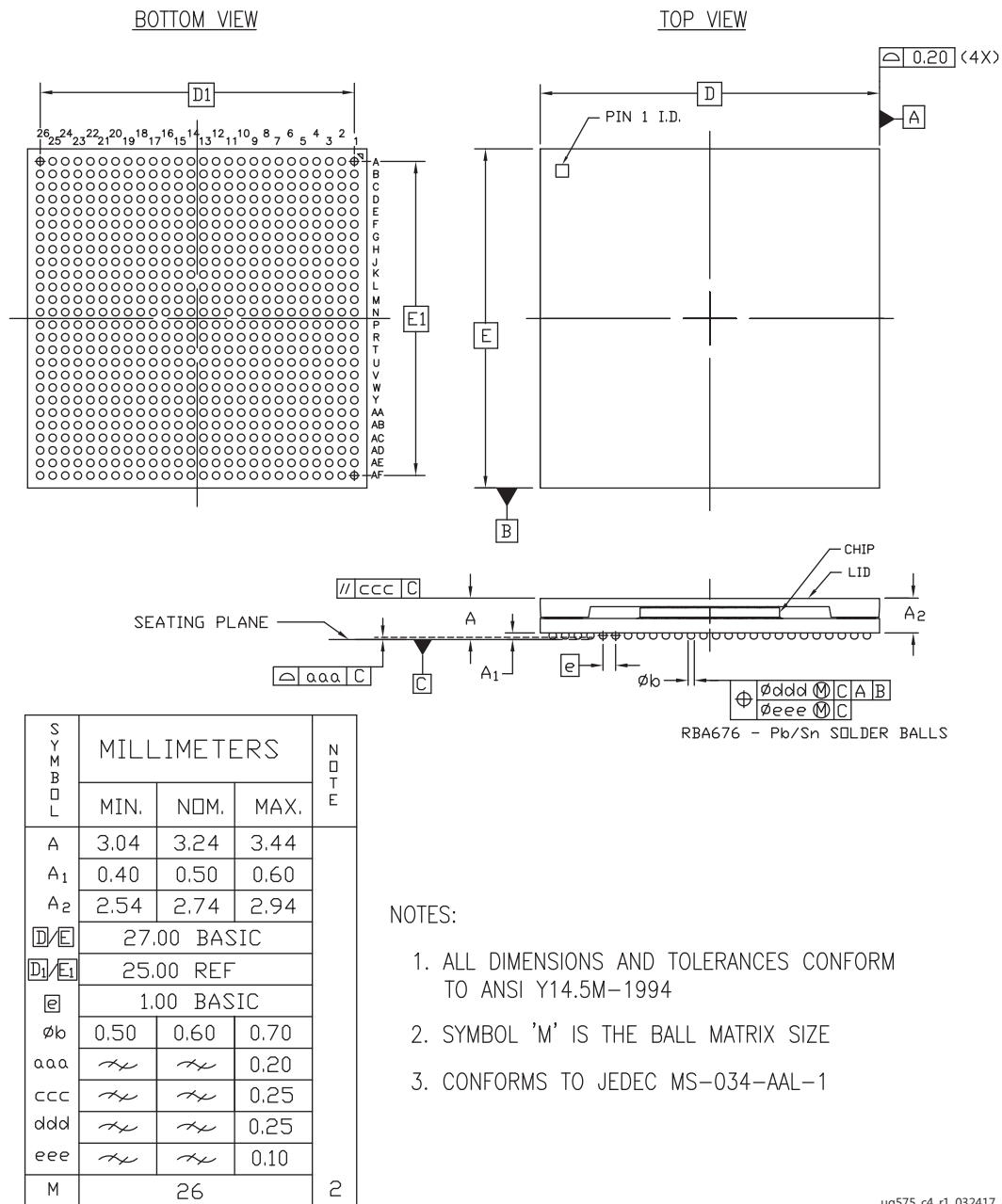
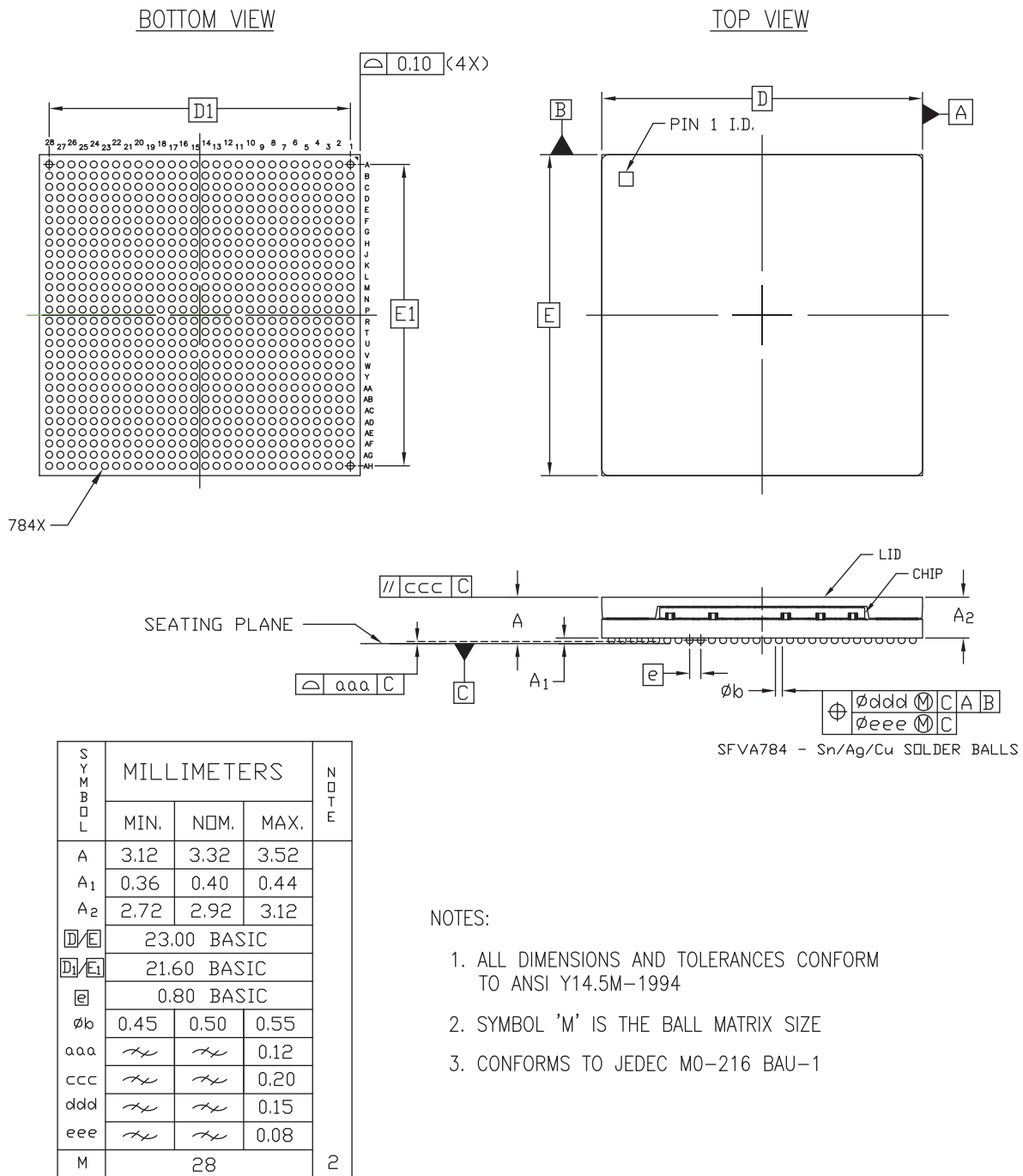

Figure 4-5: Package Dimensions for RBA676 (XQKU040)

SFVA784 Flip-Chip, Chip-Scale (0.8 mm) BGA (XCKU035 and XCKU040)



ug575_c4_23_070615

Figure 4-6: Package Dimensions for SFVA794 (XCKU035 and XCKU040)

SFVB784 Flip-Chip, Super-Fine Pitch (0.8 mm) BGA (XCKU3P and XCKU5P)

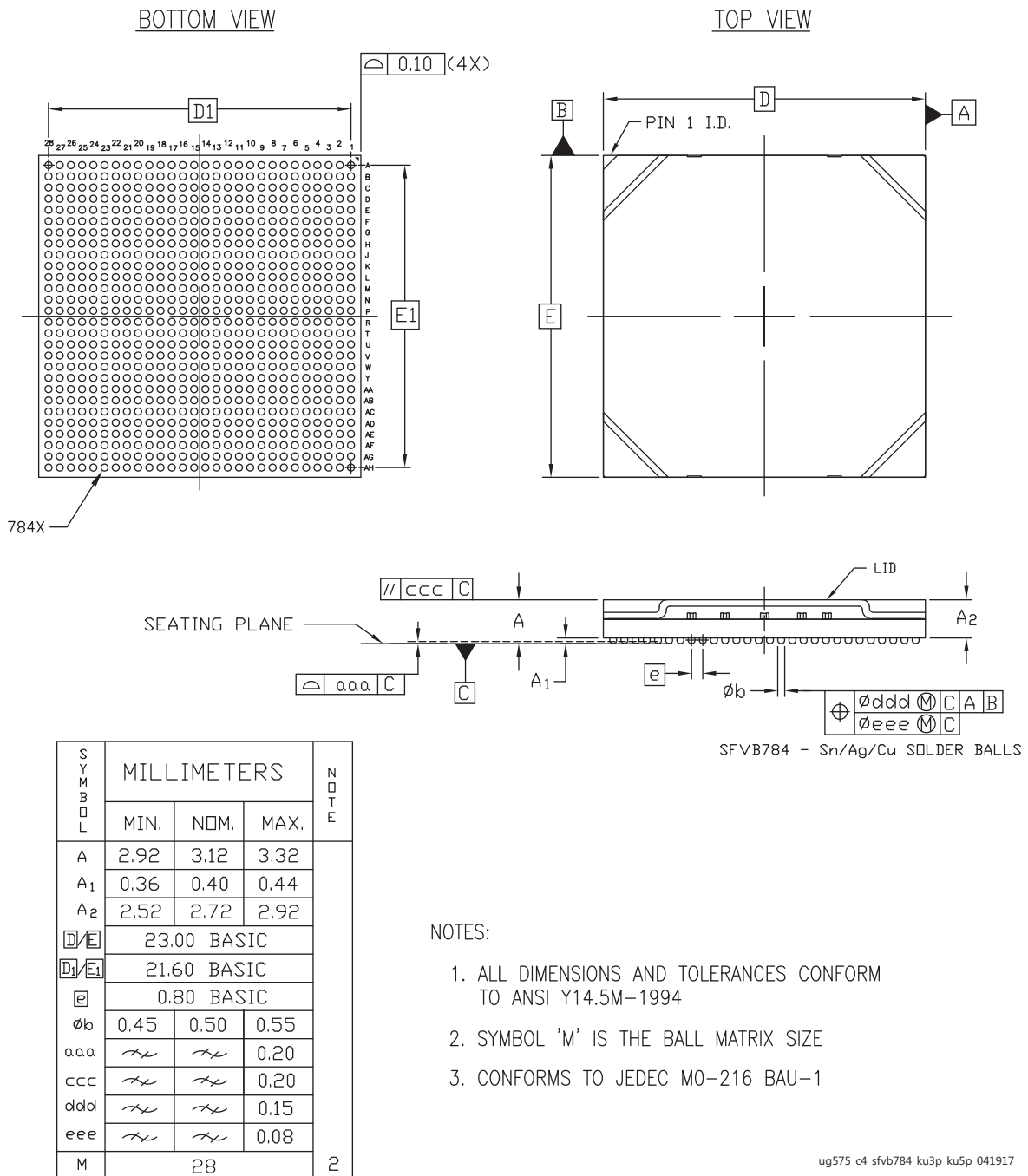

Figure 4-7: Package Dimensions for SFVB794 (XCKU3P and XCKU5P)

SFRB784 Ruggedized Flip-Chip, Super Fine-Pitch BGA (XQKU5P)

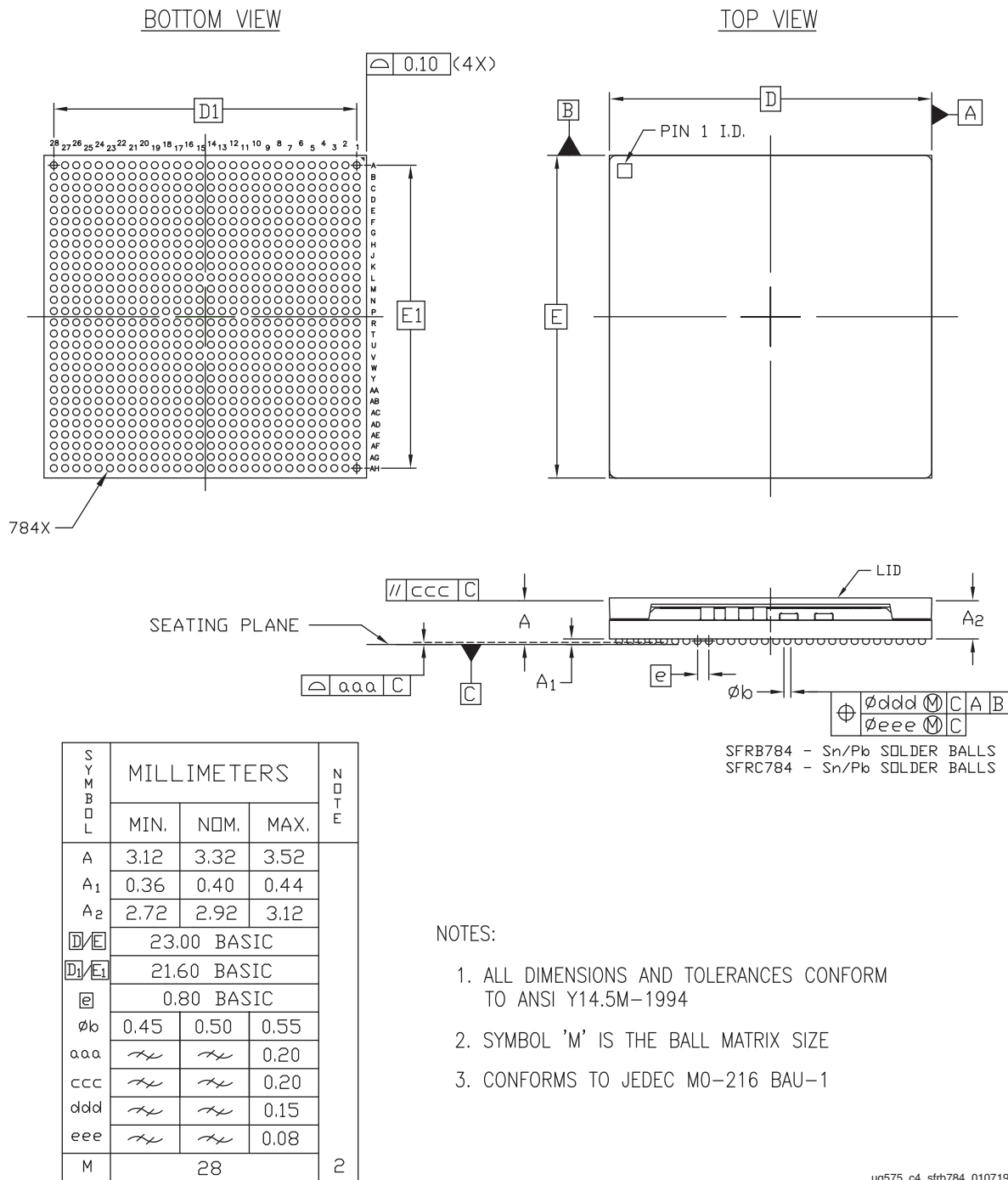
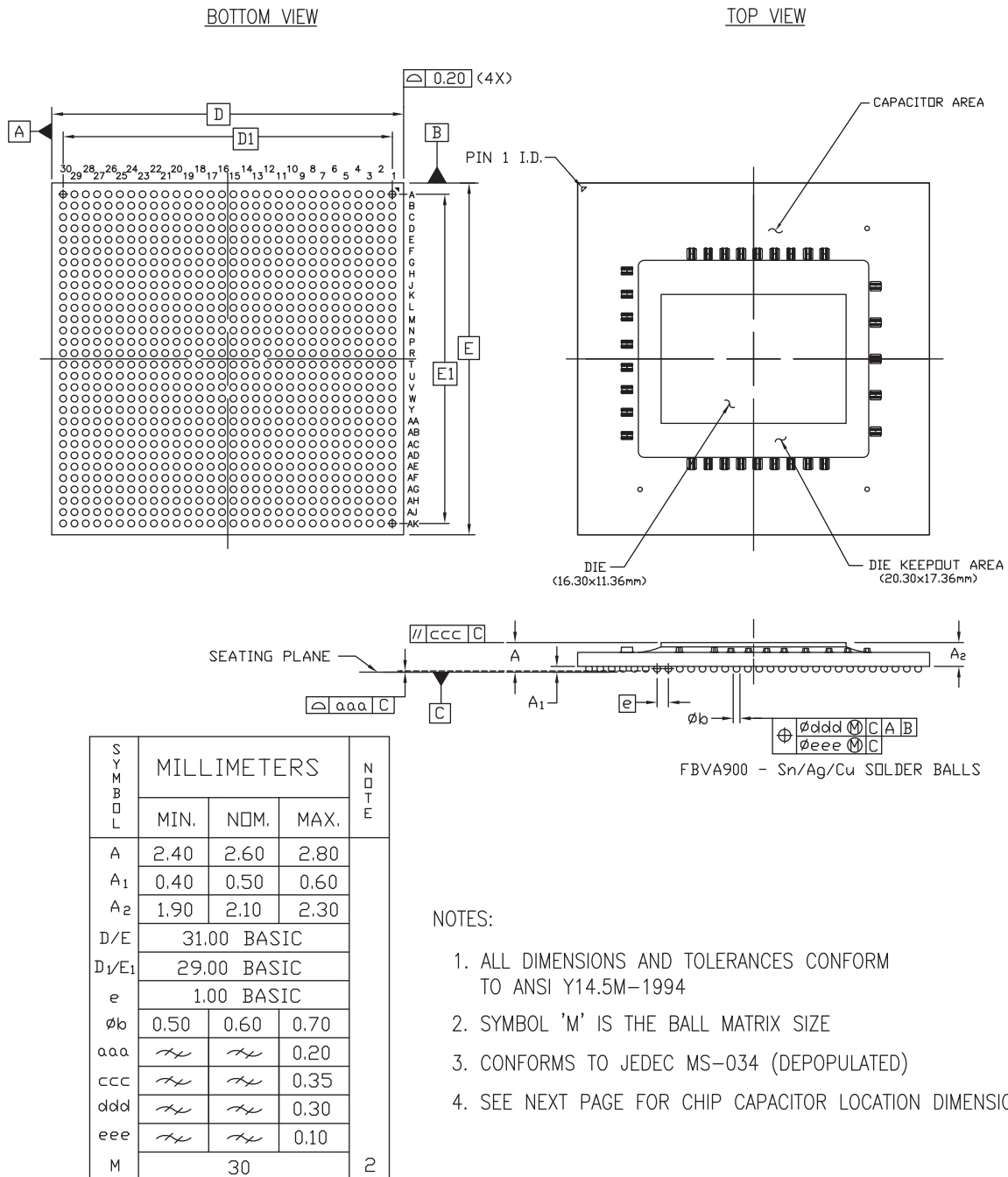

Figure 4-8: Package Dimensions for SFRB784 (XQKU5P)

FBVA900 Bare-die Flip-Chip, Fine-Pitch BGA (XCKU035 and XCKU040)



NOTES:

1. ALL DIMENSIONS AND TOLERANCES CONFORM TO ANSI Y14.5M-1994
2. SYMBOL 'M' IS THE BALL MATRIX SIZE
3. CONFORMS TO JEDEC MS-034 (DEPOPULATED)
4. SEE NEXT PAGE FOR CHIP CAPACITOR LOCATION DIMENSIONS

ug575_c4_24_041615

Figure 4-9: Package Dimensions for FBVA900 (XCKU035 and XCKU040)

CHIP CAPACITOR LAYOUT

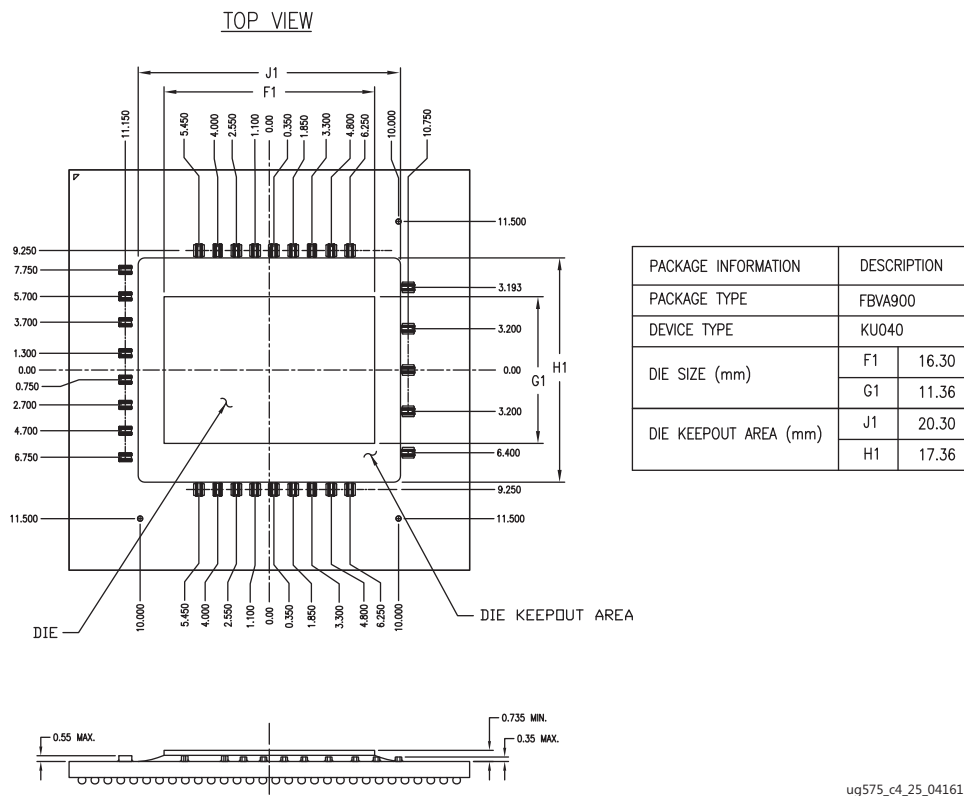
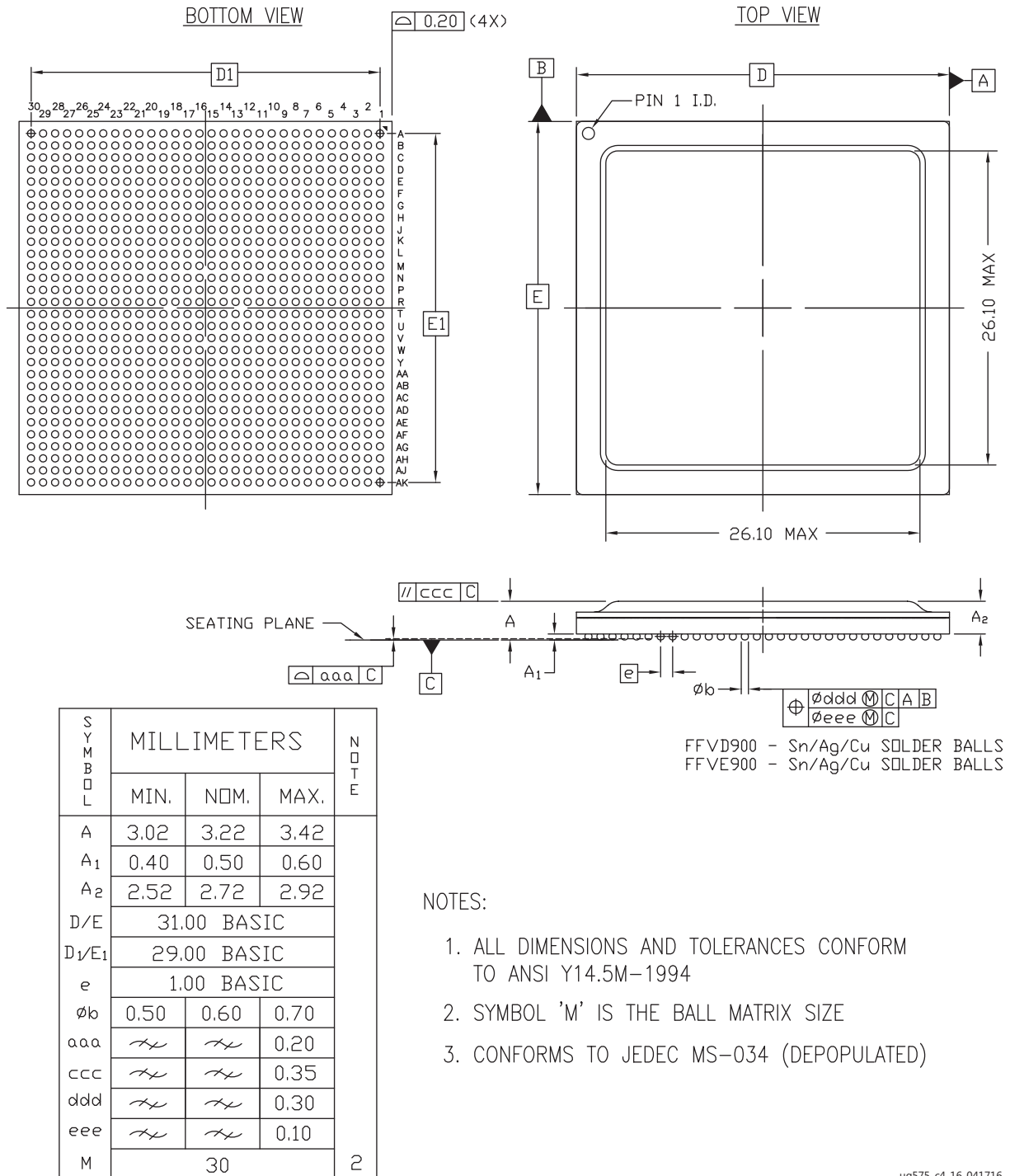

Figure 4-10: FBVA900 Package (XCKU035 and XCKU040) Die Dimensions with Capacitor Locations

FFVD900 (XCKU3P, XCKU5P, and XCKU11P) and FFVE900 (XCKU9P and XCKU13P)



ug575_c4_16_041716

Figure 4-11: Package Dimensions for FFVD900 (XCKU3P, XCKU5P, and XCKU11P) and FFVE900 (XCKU9P and XCKU13P)

FFVA1156 Flip-Chip, Fine-Pitch BGA (XCKU025, XCKU035, and XCKU040)

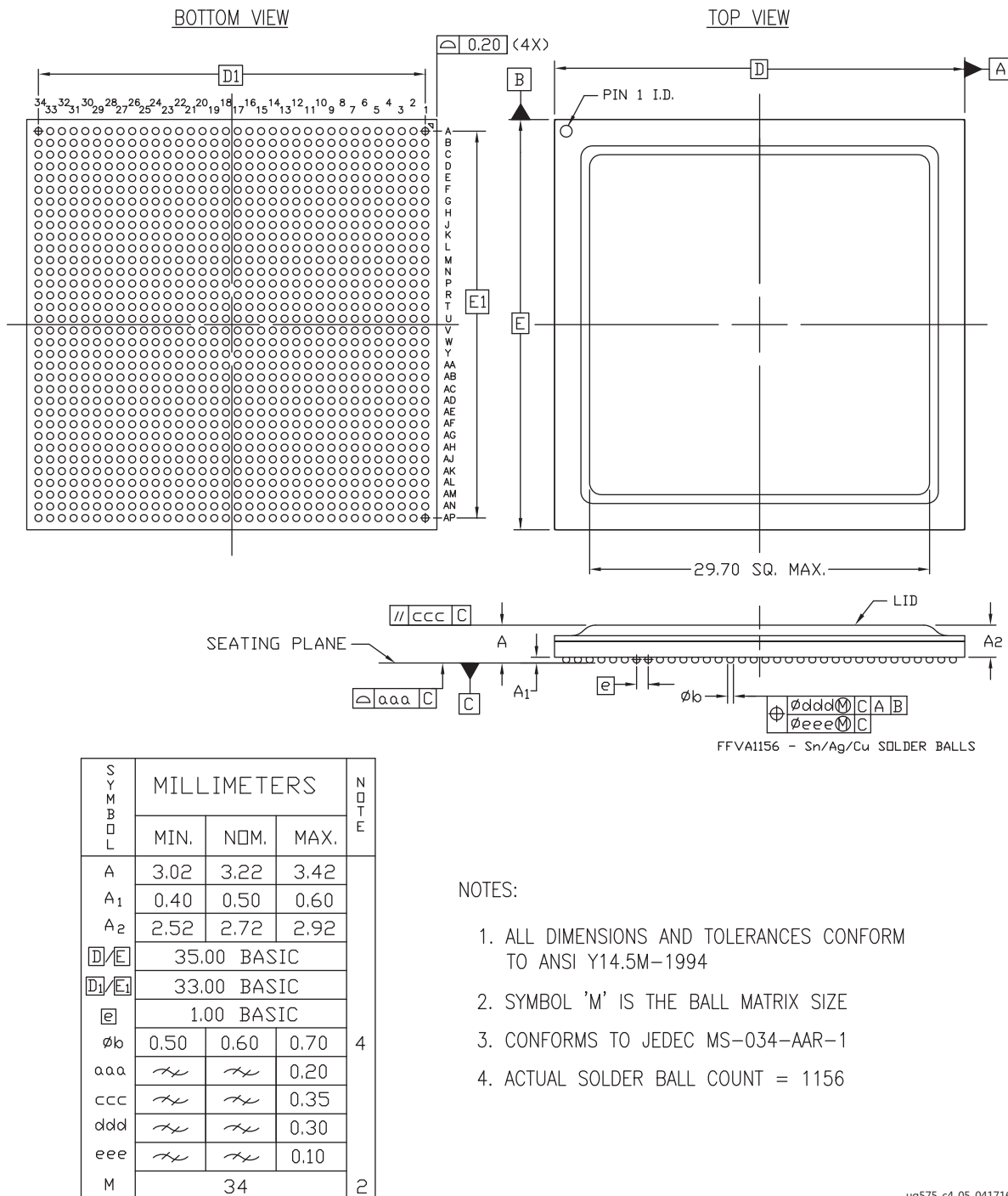
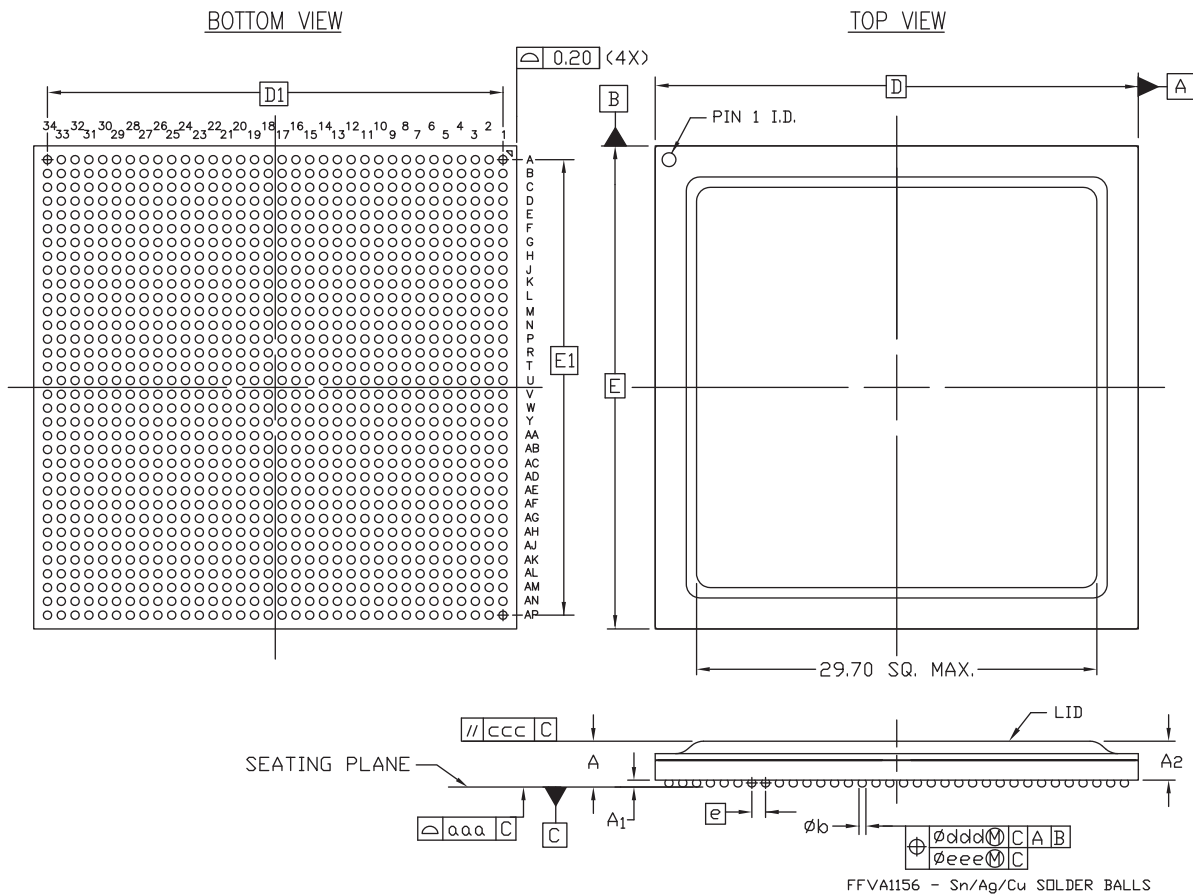

Figure 4-12: Package Dimensions for FFVA1156 (XCKU025, XCKU035, and XCKU040)

FFVA1156 Flip-Chip, Fine-Pitch BGA (XCKU060, XCKU095, and XCKU11P)



SYMBOL	MILLIMETERS			NOTE
	MIN.	NOM.	MAX.	
A	3.11	3.31	3.51	4
A ₁	0.40	0.50	0.60	
A ₂	2.61	2.81	3.01	
D/E	35.00 BASIC			
D ₁ /E ₁	33.00 BASIC			
e	1.00 BASIC			
øb	0.50	0.60	0.70	
aaa	<i>HL</i>	<i>HL</i>	0.20	
ccc	<i>HL</i>	<i>HL</i>	0.35	
ddd	<i>HL</i>	<i>HL</i>	0.30	
eee	<i>HL</i>	<i>HL</i>	0.10	
M	34			2

NOTES:

1. ALL DIMENSIONS AND TOLERANCES CONFORM TO ANSI Y14.5M-1994
2. SYMBOL 'M' IS THE BALL MATRIX SIZE
3. CONFORMS TO JEDEC MS-034-AAR-1
4. ACTUAL SOLDER BALL COUNT = 1156

ug575_c4_06_041716

Figure 4-13: Package Dimensions for FFVA1156 (XCKU060, XCKU095, and XCKU11P)

FFVA1156 Flip-Chip, Fine-Pitch BGA (XCKU15P)

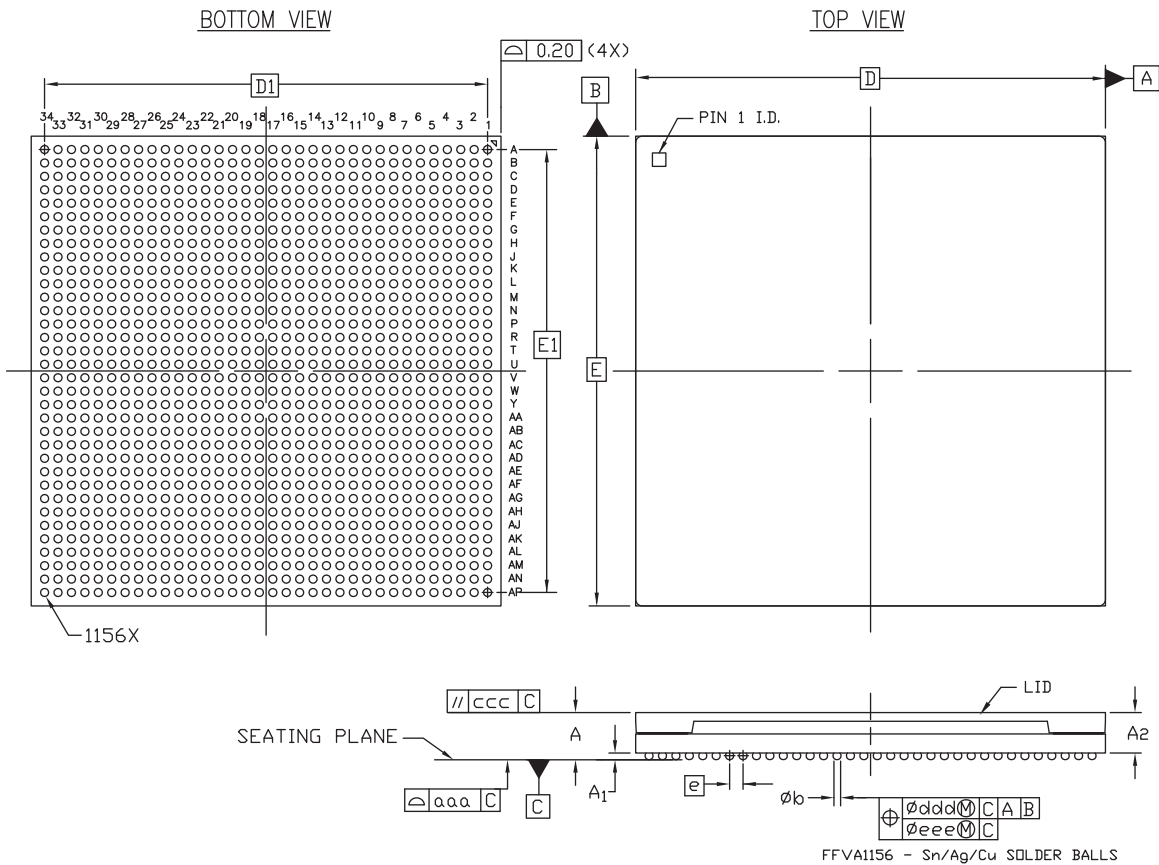

SYMBOL	MILLIMETERS			NOTE
	MIN.	NOM.	MAX.	
A	3.31	3.51	3.71	
A ₁	0.40	0.50	0.60	
A ₂	2.81	3.01	3.21	
D/E	35.00 BASIC			
D ₁ /E ₁	33.00 BASIC			
e	1.00 BASIC			
øb	0.50	0.60	0.70	
aaa	<i>HL</i>	<i>HL</i>	0.20	
ccc	<i>HL</i>	<i>HL</i>	0.35	
ddd	<i>HL</i>	<i>HL</i>	0.30	
eee	<i>HL</i>	<i>HL</i>	0.10	
M	34			2

NOTES:

1. ALL DIMENSIONS AND TOLERANCES CONFORM TO ANSI Y14.5M-1994
2. SYMBOL 'M' IS THE BALL MATRIX SIZE
3. CONFORMS TO JEDEC MS-034-AAR-1

ug575_c4_ffva1156_ku15p_041917

Figure 4-14: Package Dimensions for FFVA1156 (XCKU15P)

FFRA1156 Ruggedized Flip-Chip, Fine-Pitch BGA (XQKU15P)

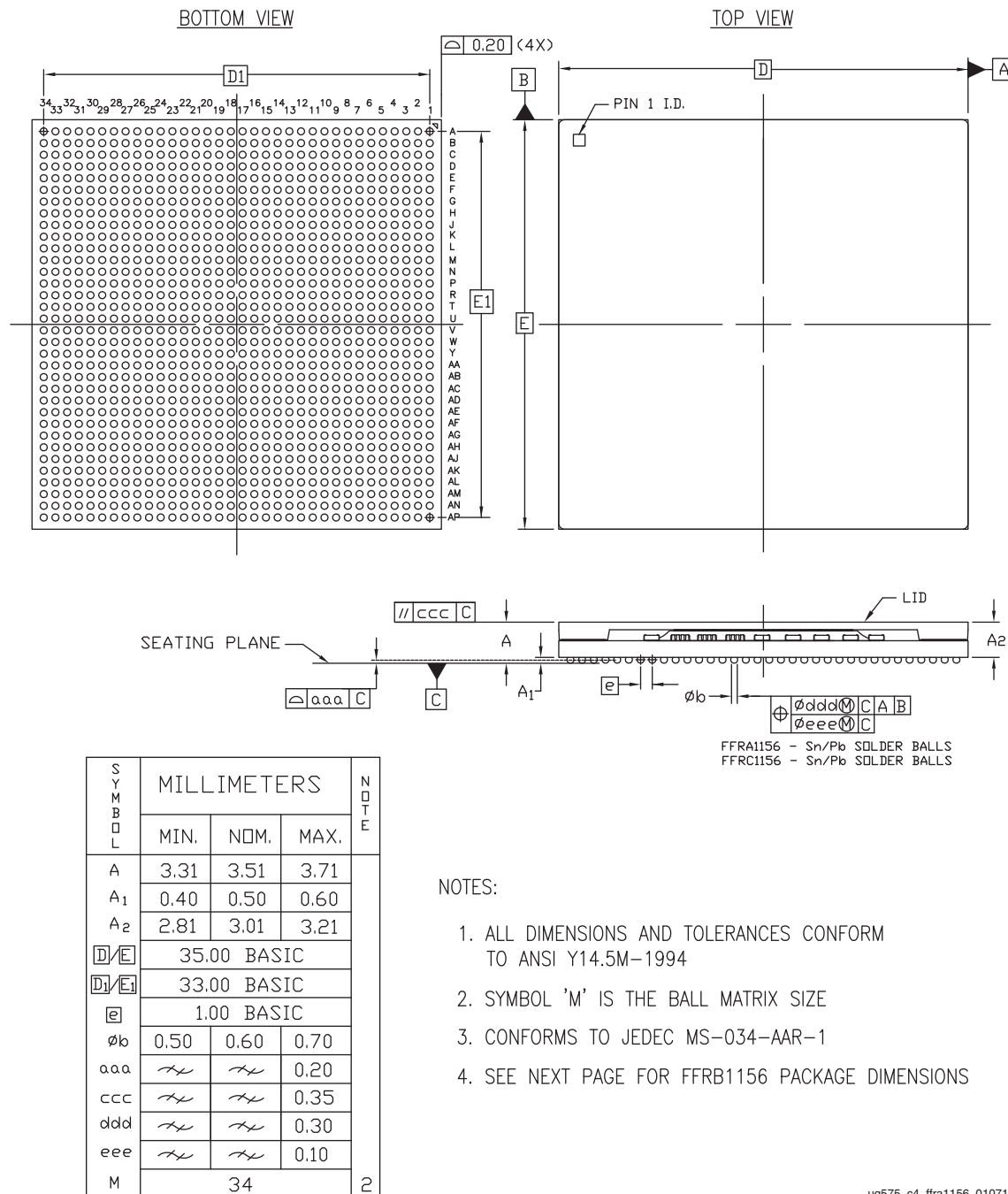

Figure 4-15: Package Dimensions for FFRA1156 (XQKU15P)

RFA1156 Ruggedized Flip-Chip, Fine-Pitch BGA (XQKU040)

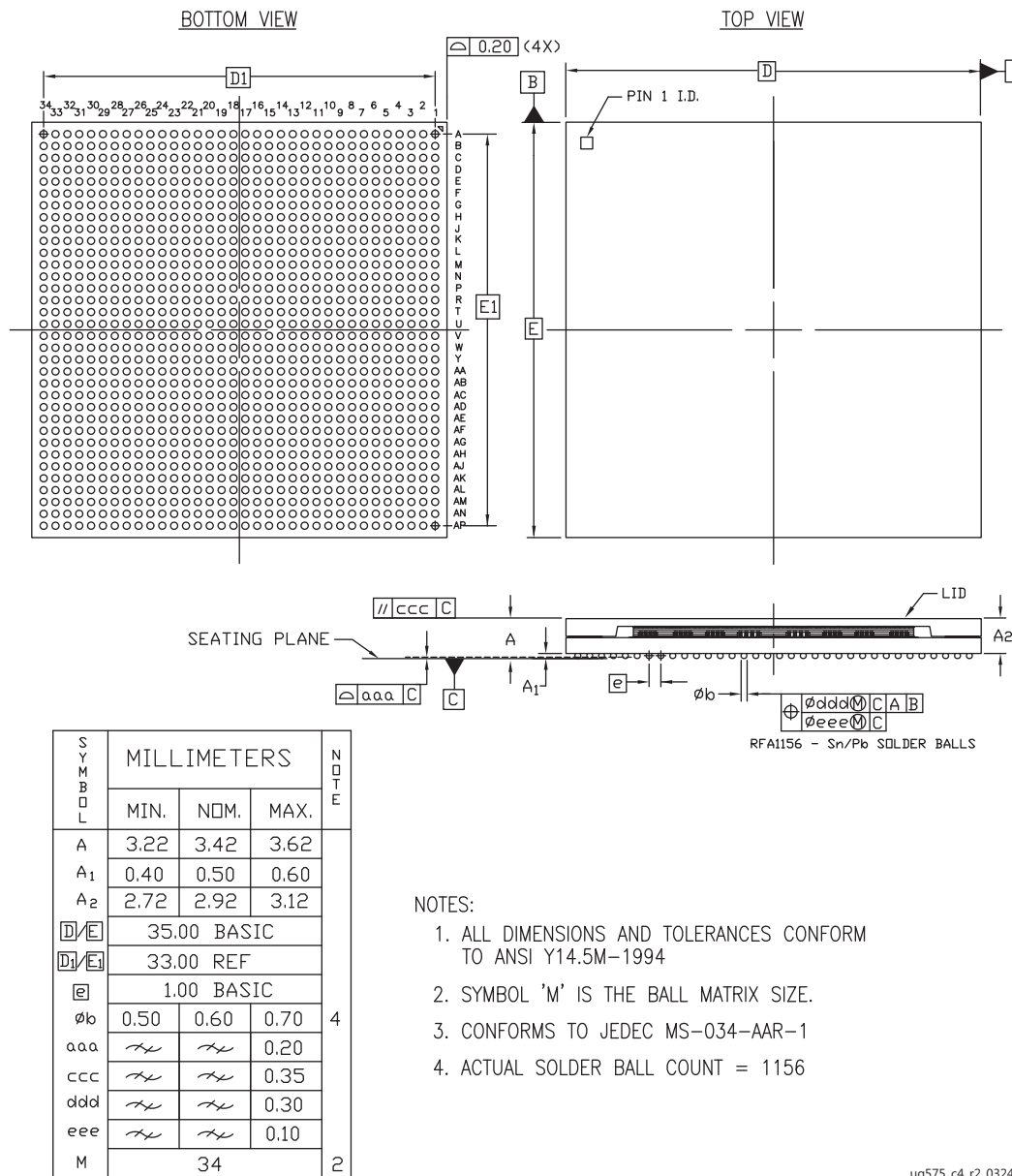

Figure 4-16: Package Dimensions for RFA1156 (XQKU040)

RFA1156 Ruggedized Flip-Chip, Fine-Pitch BGA (XQKU060 and XQKU095)

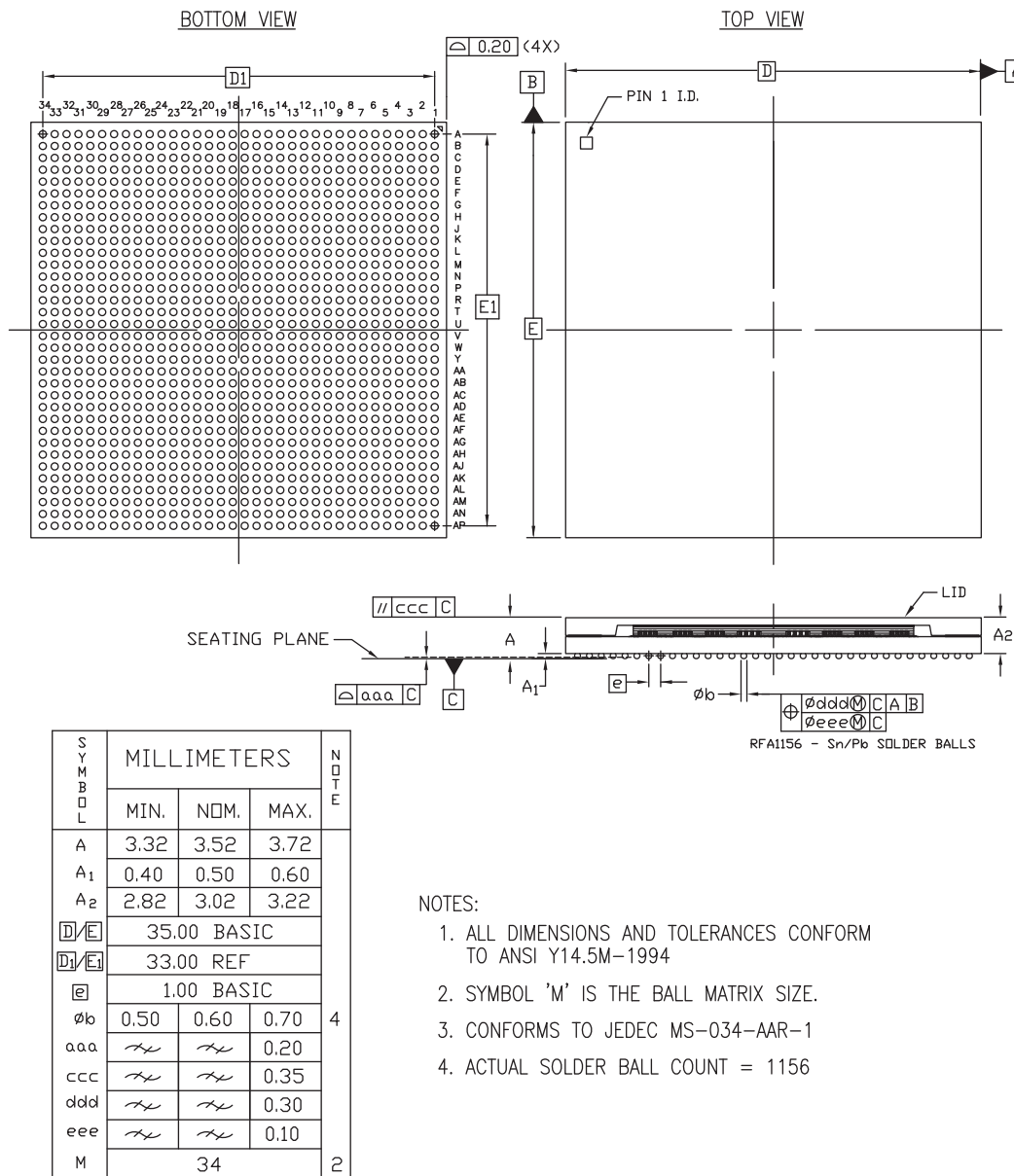

Figure 4-17: Package Dimensions for RFA1156 (XQKU060 and XQKU095)

FFVA1517, FFVC1517, and FFVD1517 Flip-Chip, Fine-Pitch BGA (XCKU060, XCKU095, XCVU065, XCVU080, XCVU095)

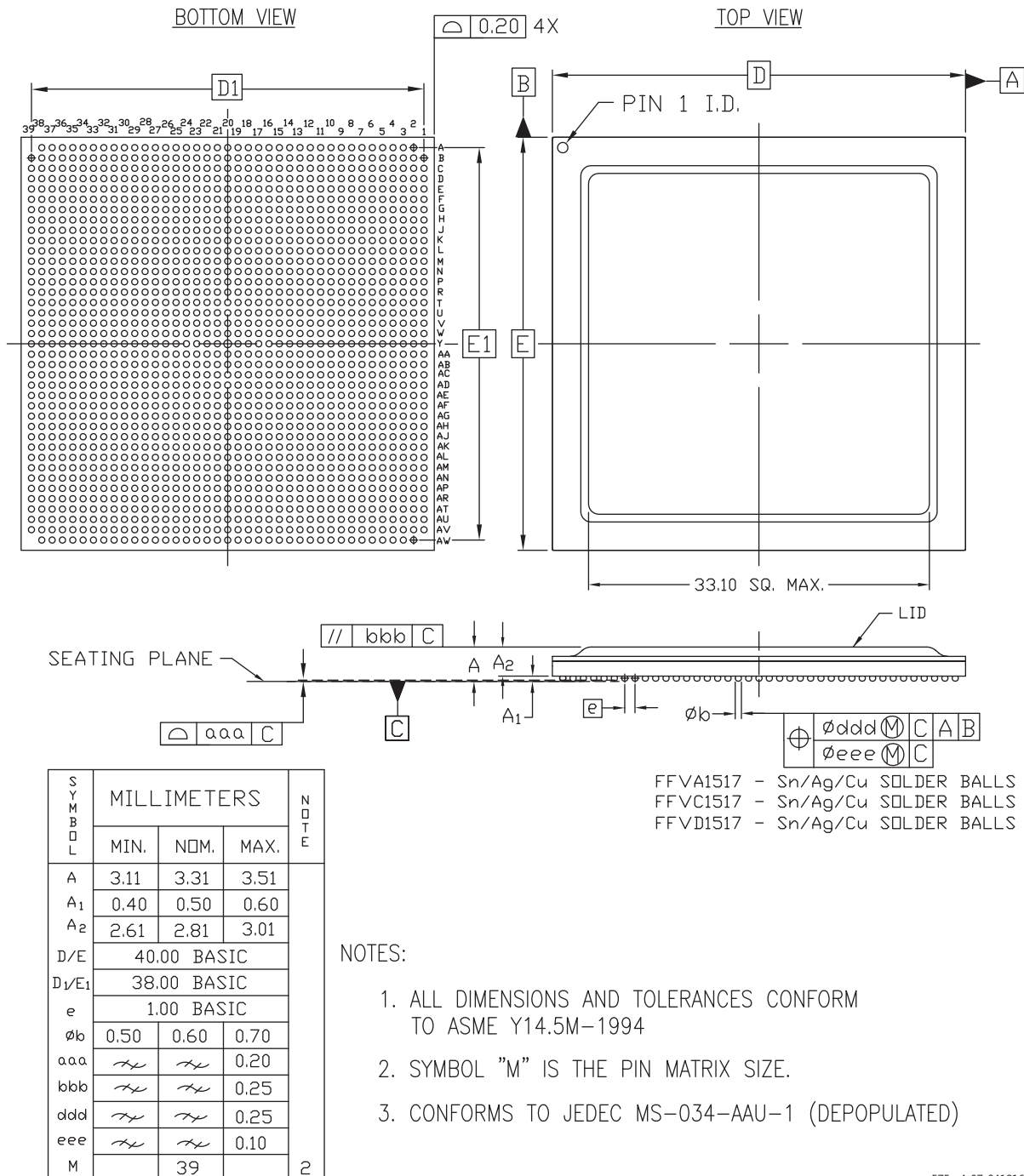

Figure 4-18: Package Dimensions for FFVA1517 (XCKU060), FFVC1517 (XCKU095, XCVU065, XCVU080, and XCVU095) and FFVD1517 (XCVU080 and XCVU095)

FFVC1517 (XCVU3P) and FFVE1517 (XCKU11P and XCKU15P) Flip-Chip, Fine-Pitch BGA

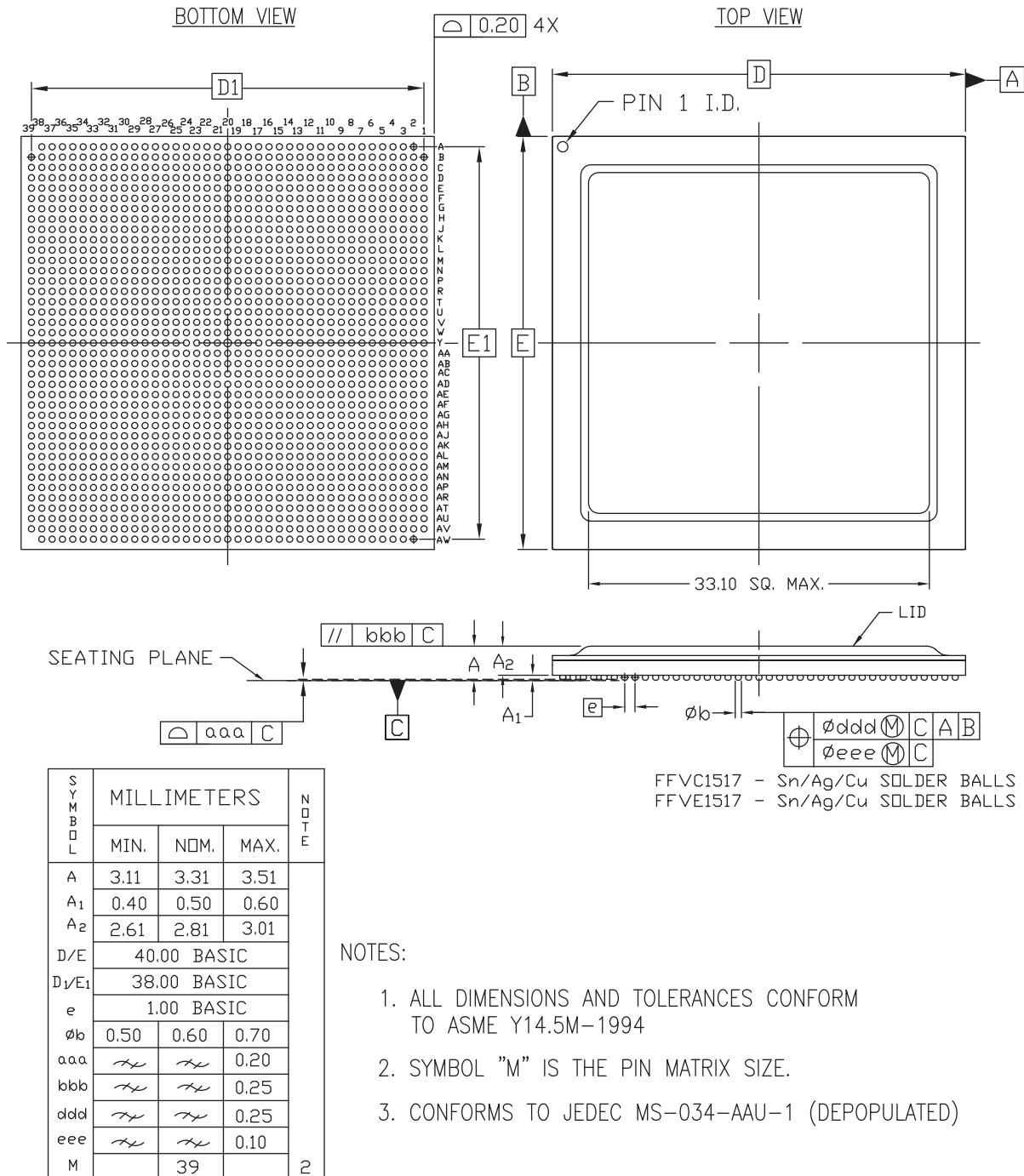
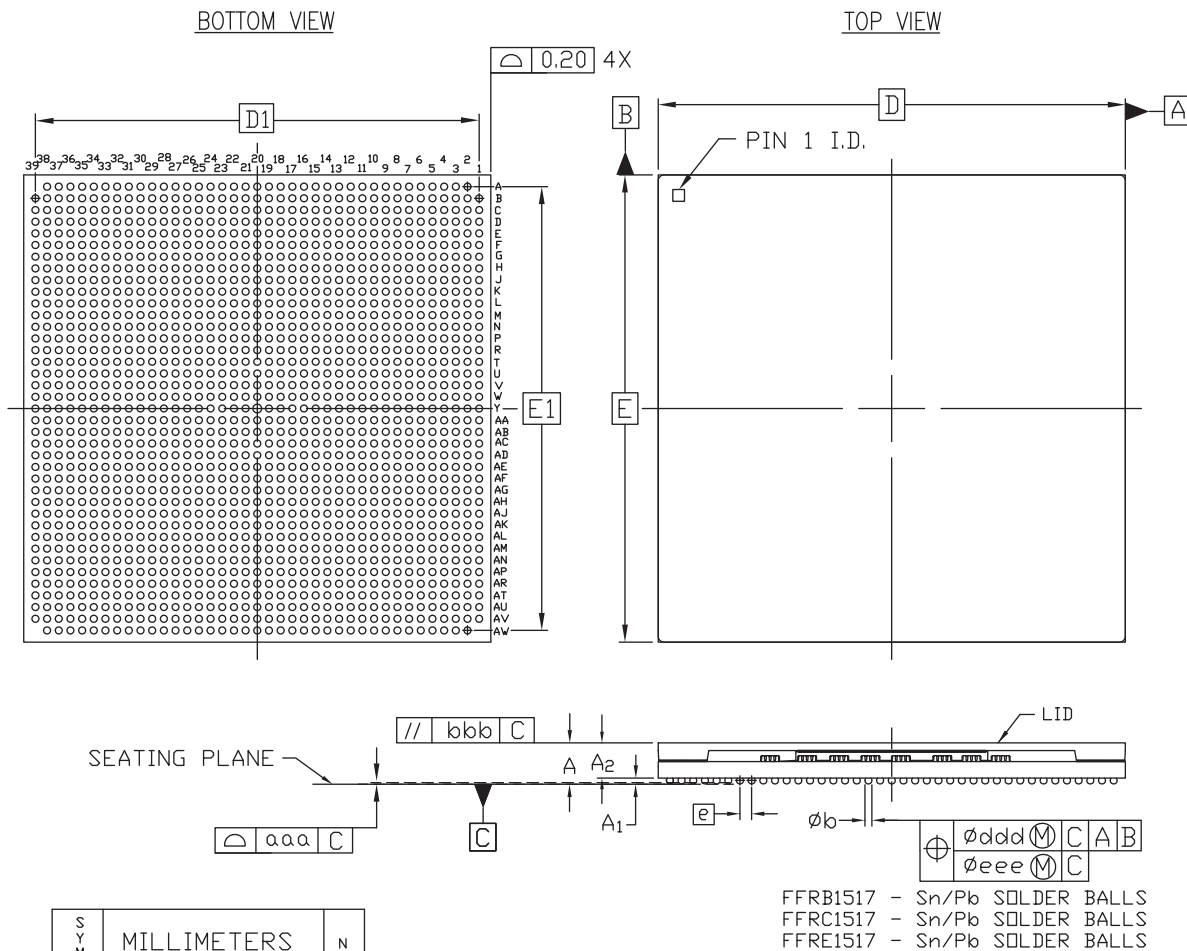

Figure 4-19: Package Dimensions for FFVC1517 (XCVU3P) and FFVE1517 (XCKU11P and XCKU15P)

FFRC1517 (XQVU3P) and FFRE1517 (XQKU15P) Ruggedized Flip-Chip, Fine-Pitch BGA



NOTES:

1. ALL DIMENSIONS AND TOLERANCES CONFORM TO ASME Y14.5M-1994
2. SYMBOL "M" IS THE PIN MATRIX SIZE.
3. CONFORMS TO JEDEC MS-034-AAU-1 (DEPOPULATED)

ug575_c4_ffrc1517_ffre1517_010719

Figure 4-20: Package Dimensions for FFRC1517 (XQVU3P) and FFRE1517 (XQKU15P)

FLVA1517 (XCKU085 and XCKU115) and FLVD1517 (XCKU115 and XCVU125) Flip-Chip, Fine-Pitch BGA

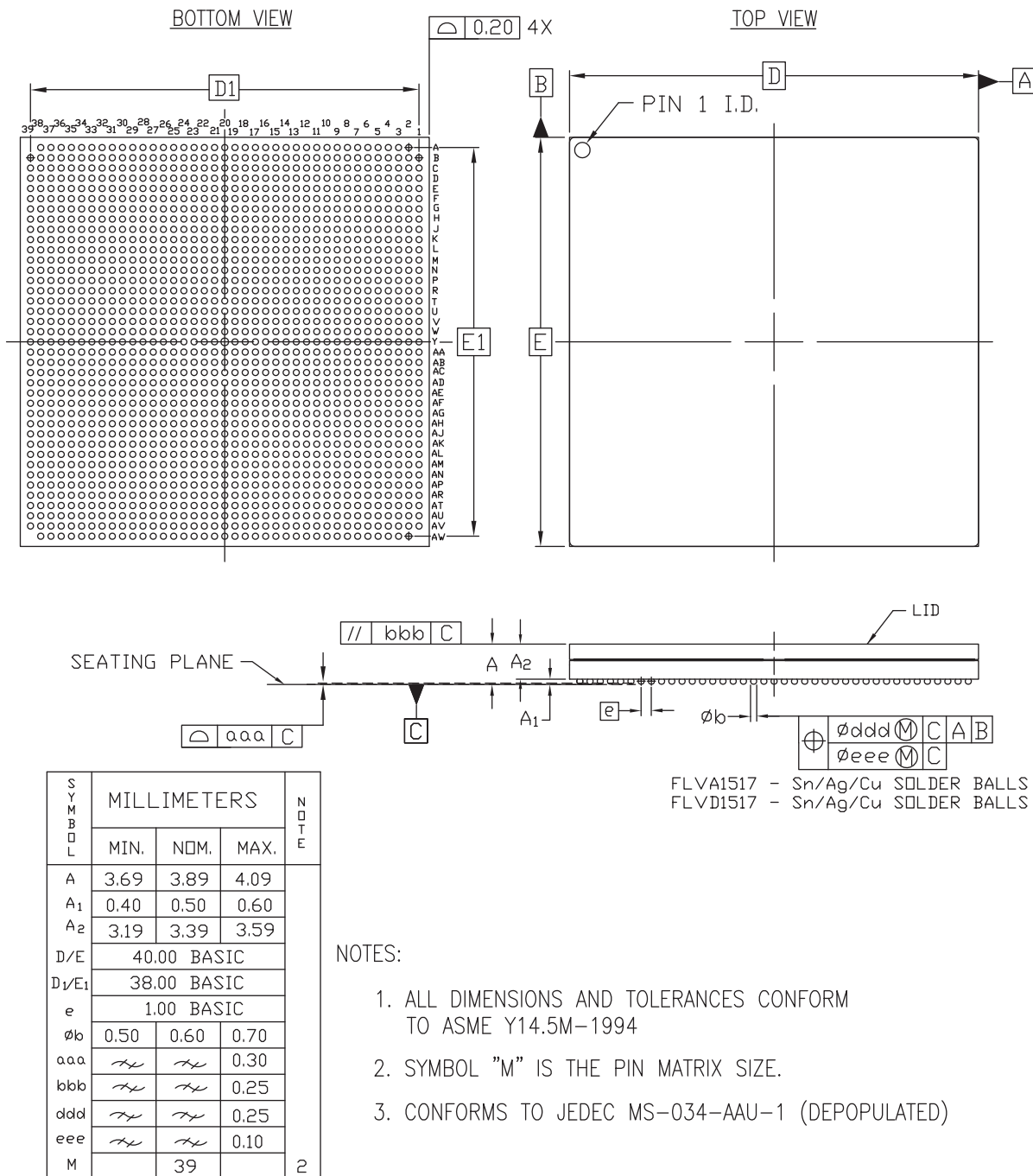

Figure 4-21: Package Dimensions for FLVA1517 (XCKU085 and XCKU115) and FLVD1517 (XCKU115 and XCVU125)

RLD1517 Ruggedized Flip-Chip, Fine-Pitch BGA (XQKU115)

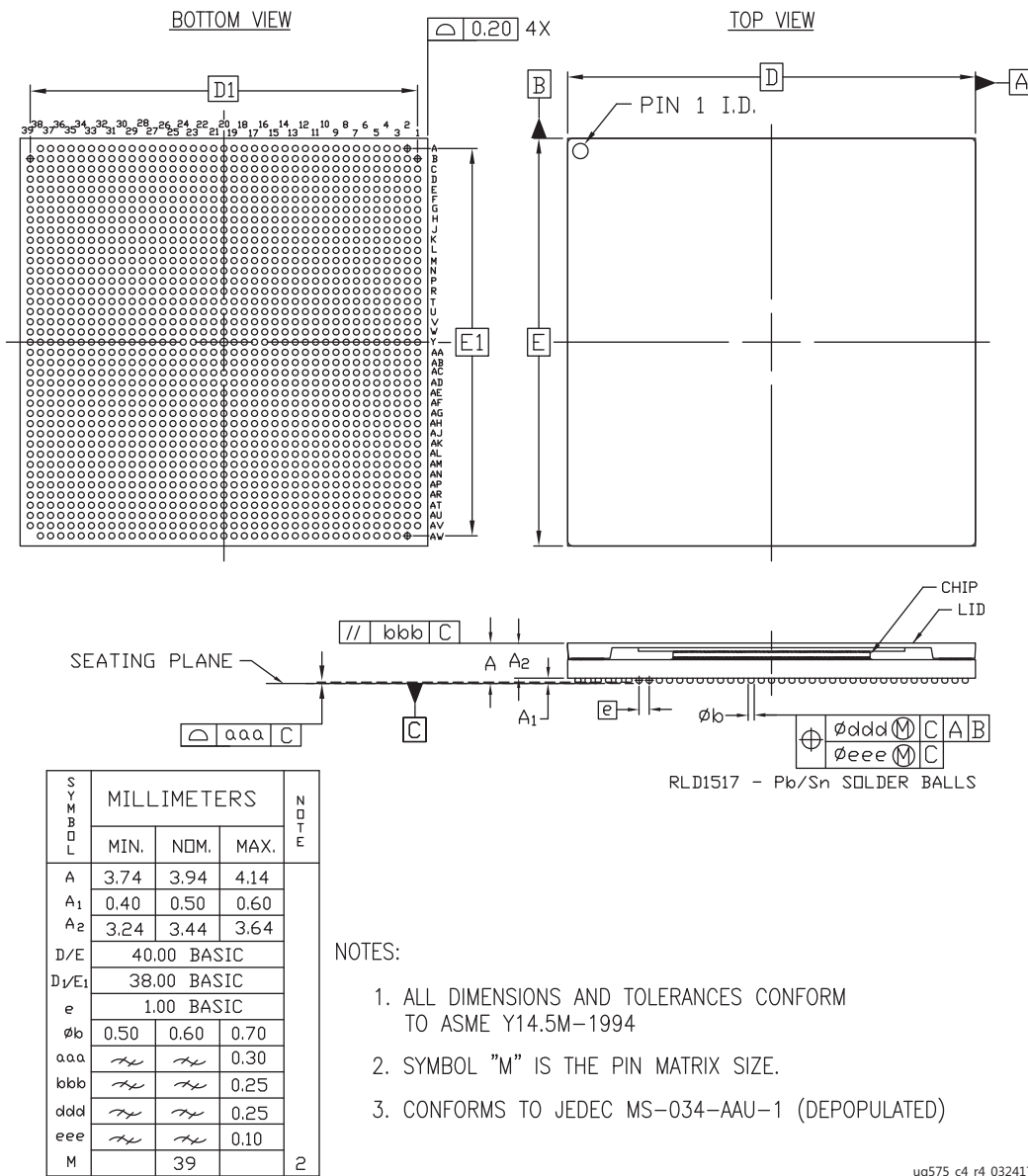

Figure 4-22: Package Dimensions for RLD1517 (XQKU115)

FFVA1760 Flip-Chip, Fine-Pitch BGA (XCKU15P)

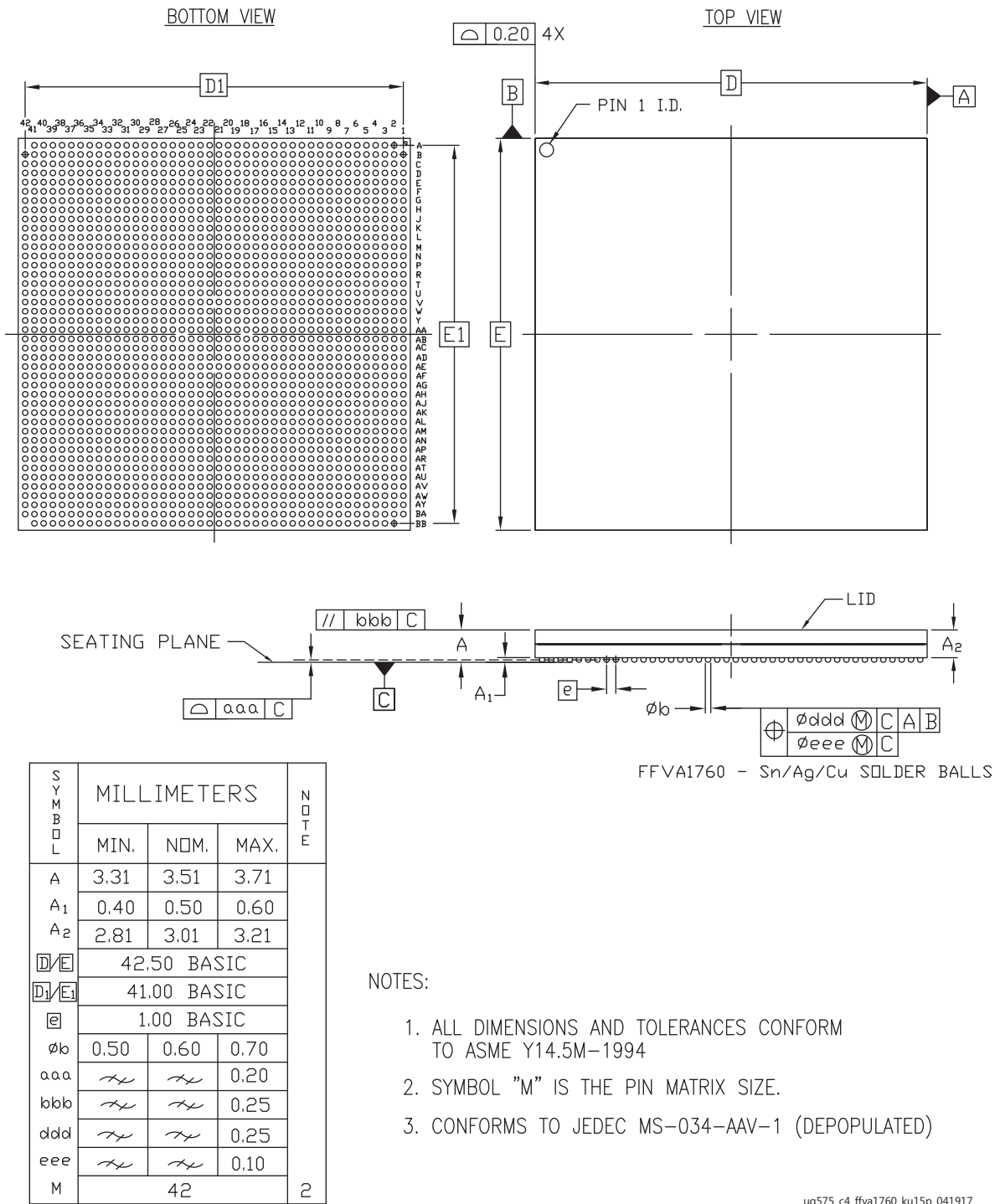

Figure 4-23: Package Dimensions for FFVA1760 (XCKU15P)

FFVB1760 Flip-Chip, Fine-Pitch BGA (XCKU095, XCVU080, and XCVU095)

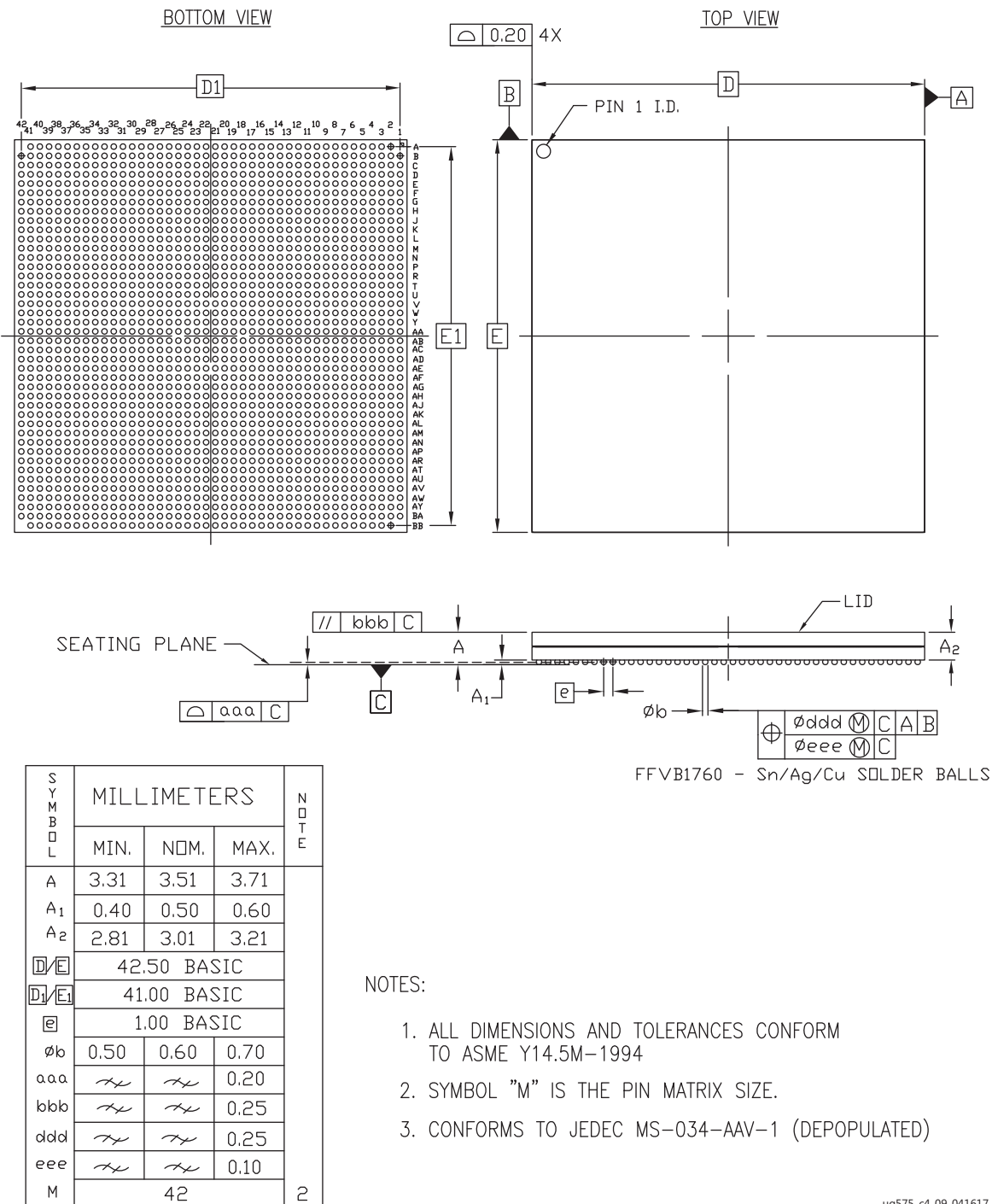
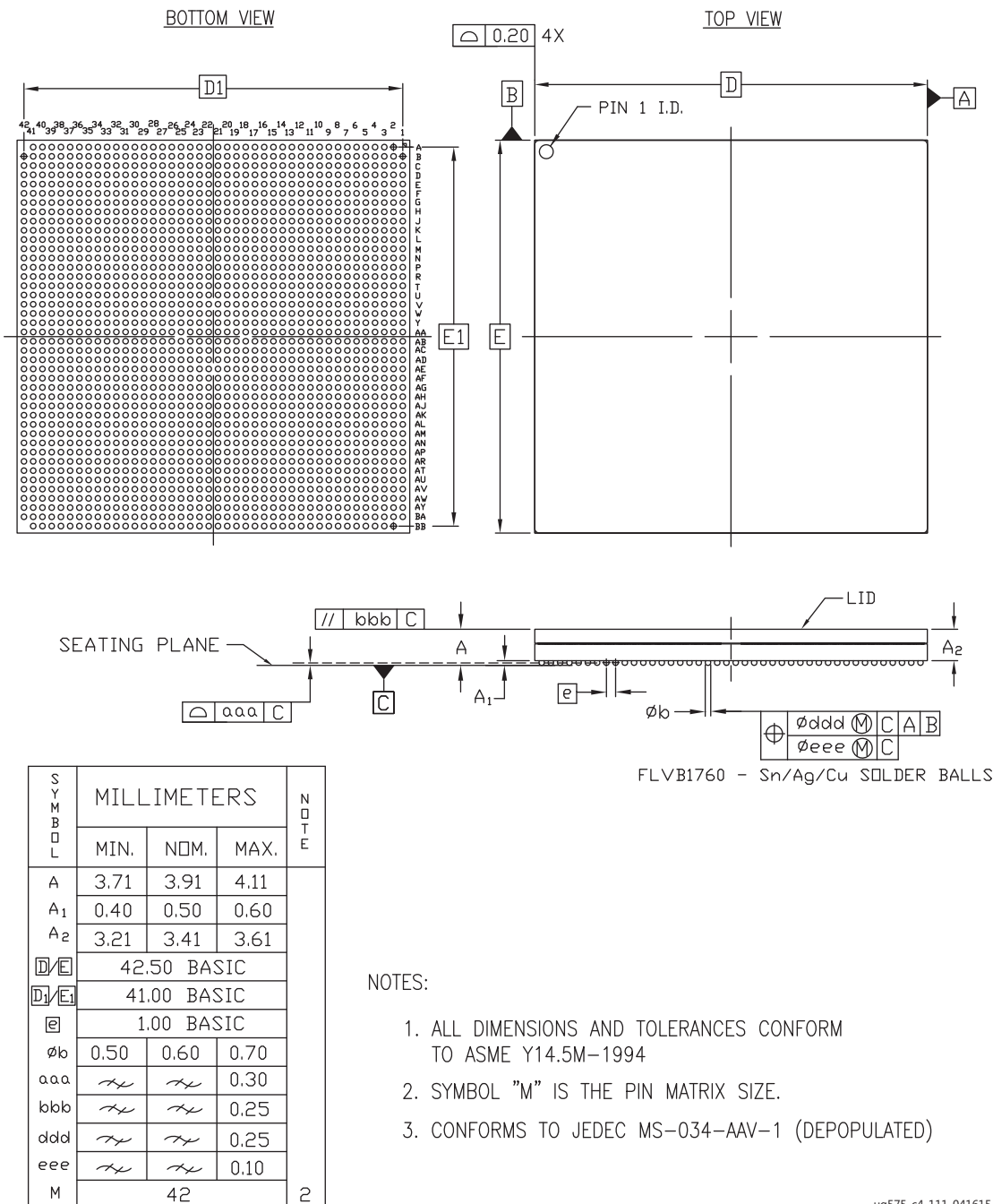

Figure 4-24: Package Dimensions for FFVB1760 (XCKU095, XCVU080, and XCVU095)

FLVB1760 Flip-Chip, Fine-Pitch BGA (XCKU085, XCKU115, and XCVU125)



ug575_c4_111_041615

Figure 4-25: Package Dimensions for FLVB1760 (XCKU085, XCKU115, and XCVU125)

FFVE1760 Flip-Chip, Fine-Pitch BGA (XCKU15P)

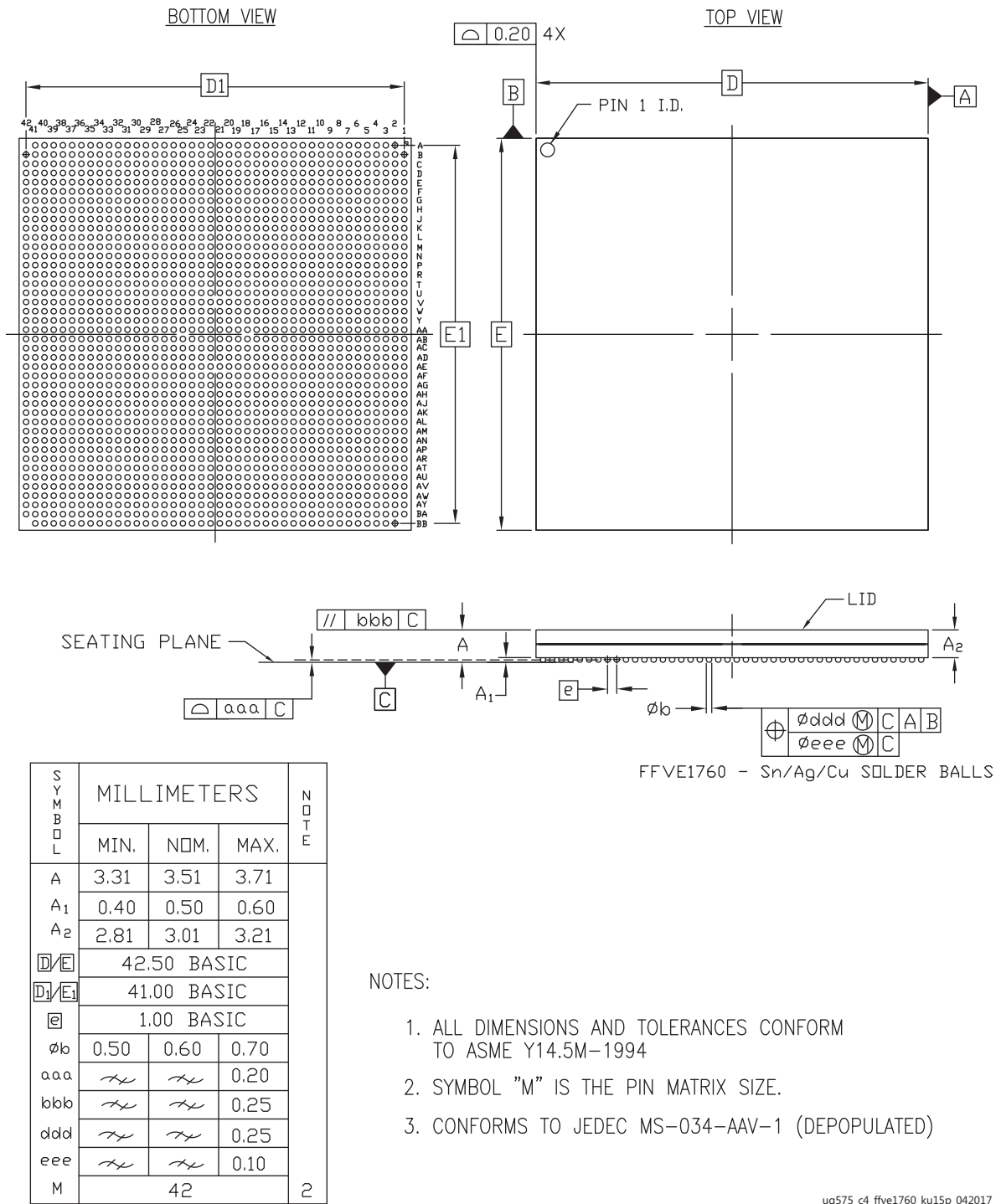

Figure 4-26: Package Dimensions for FFVE1760 (XCKU15P)

FLVD1924 (XCKU115) and FLVF1924 (XCKU085 and XCKU115) Flip-Chip, Fine-Pitch BGA

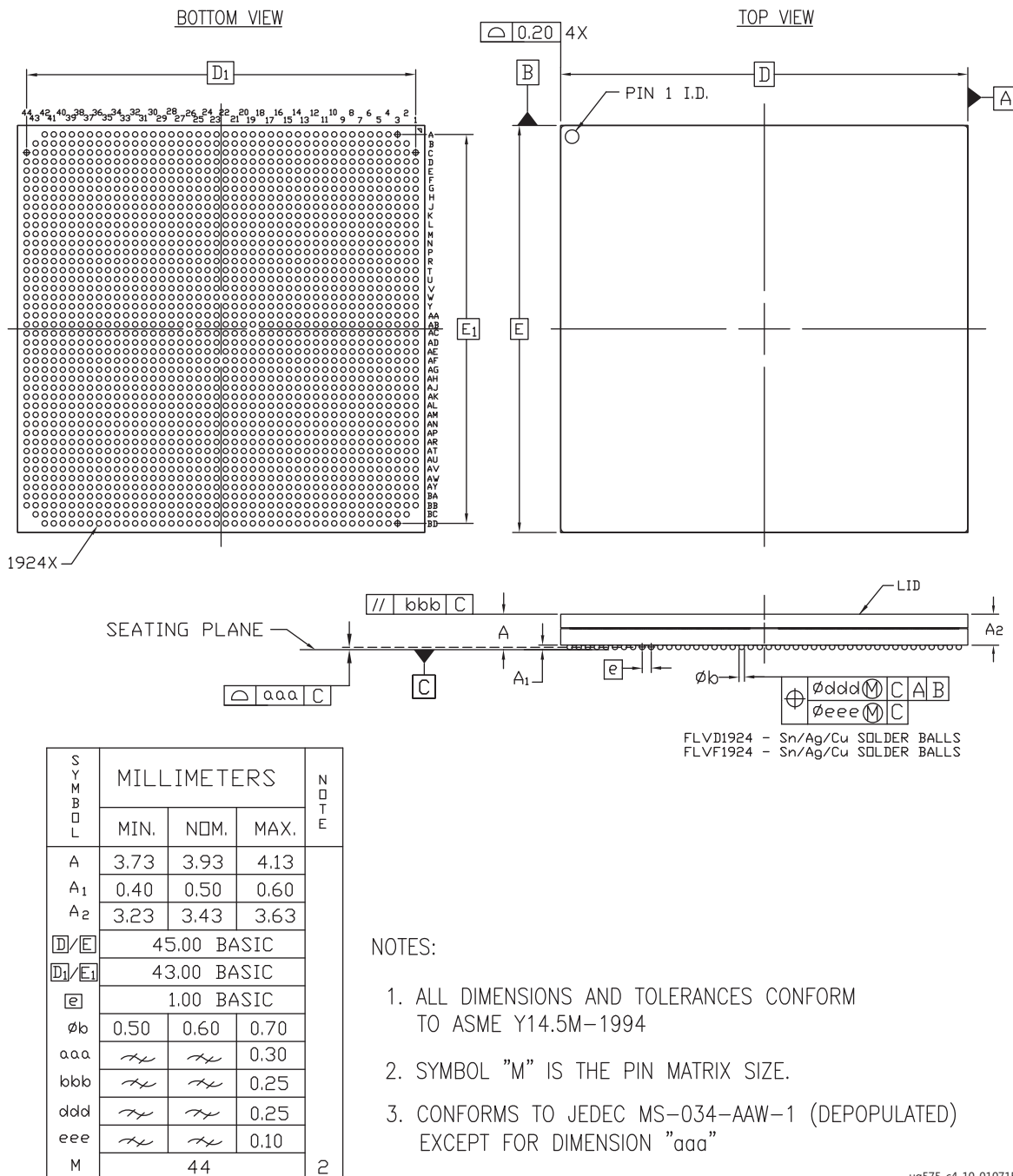

Figure 4-27: Package Dimensions for FLVD1924 (XCKU115) and FLVF1924 (XCKU085 and XCKU115)

FLGF1924 (XCVU11P) Flip-Chip, Fine-Pitch BGA

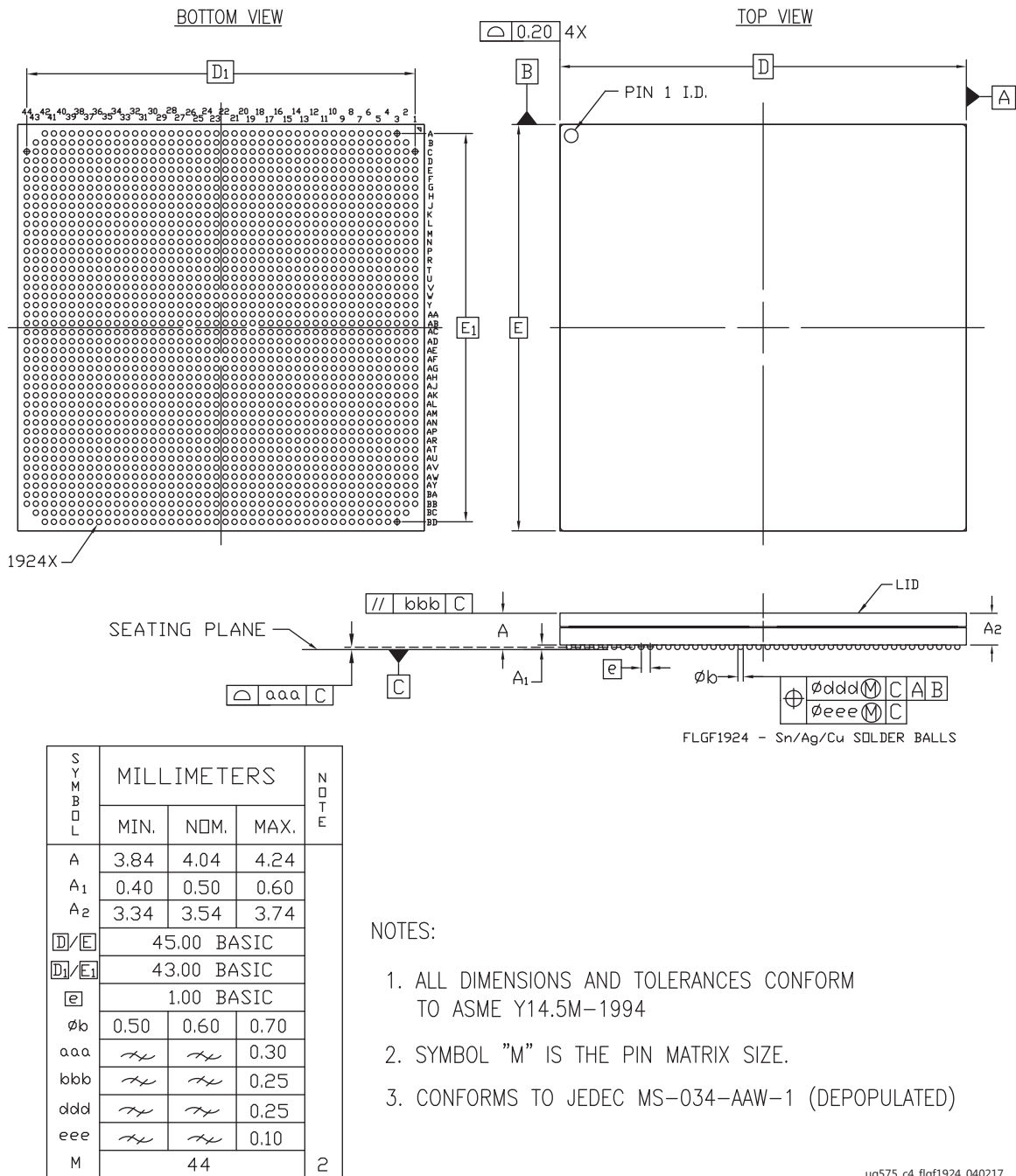

Figure 4-28: Package Dimensions for FLGF1924 (XCVU11P)

RLF1924 (XQKU115) Ruggedized Flip-Chip, Fine-Pitch BGA

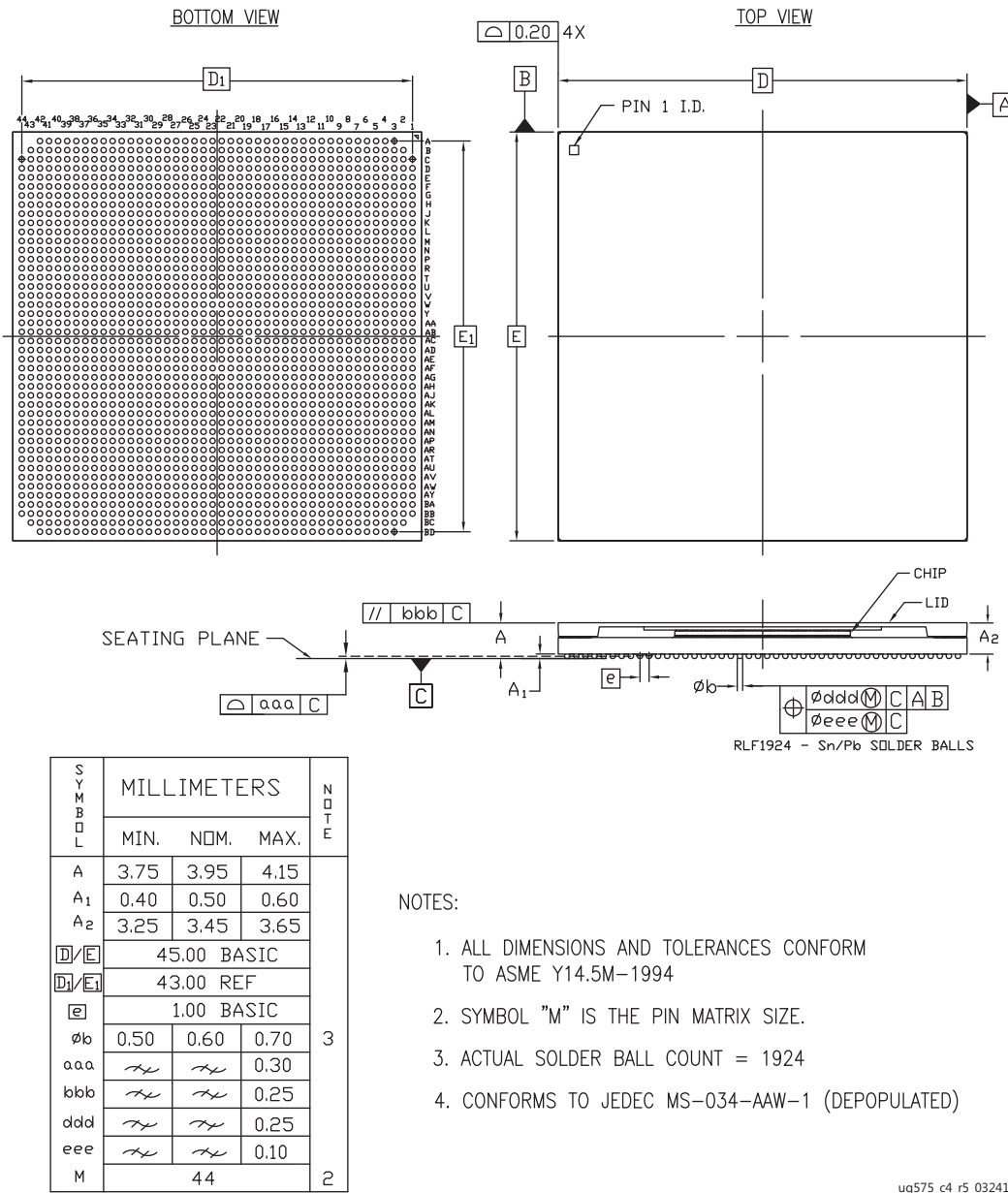

Figure 4-29: Package Dimensions for RLF1924 (XQKU115)

FSVH1924 (XCVU31P) Flip-Chip, Fine-Pitch, Lidless with Stiffener Ring, BGA

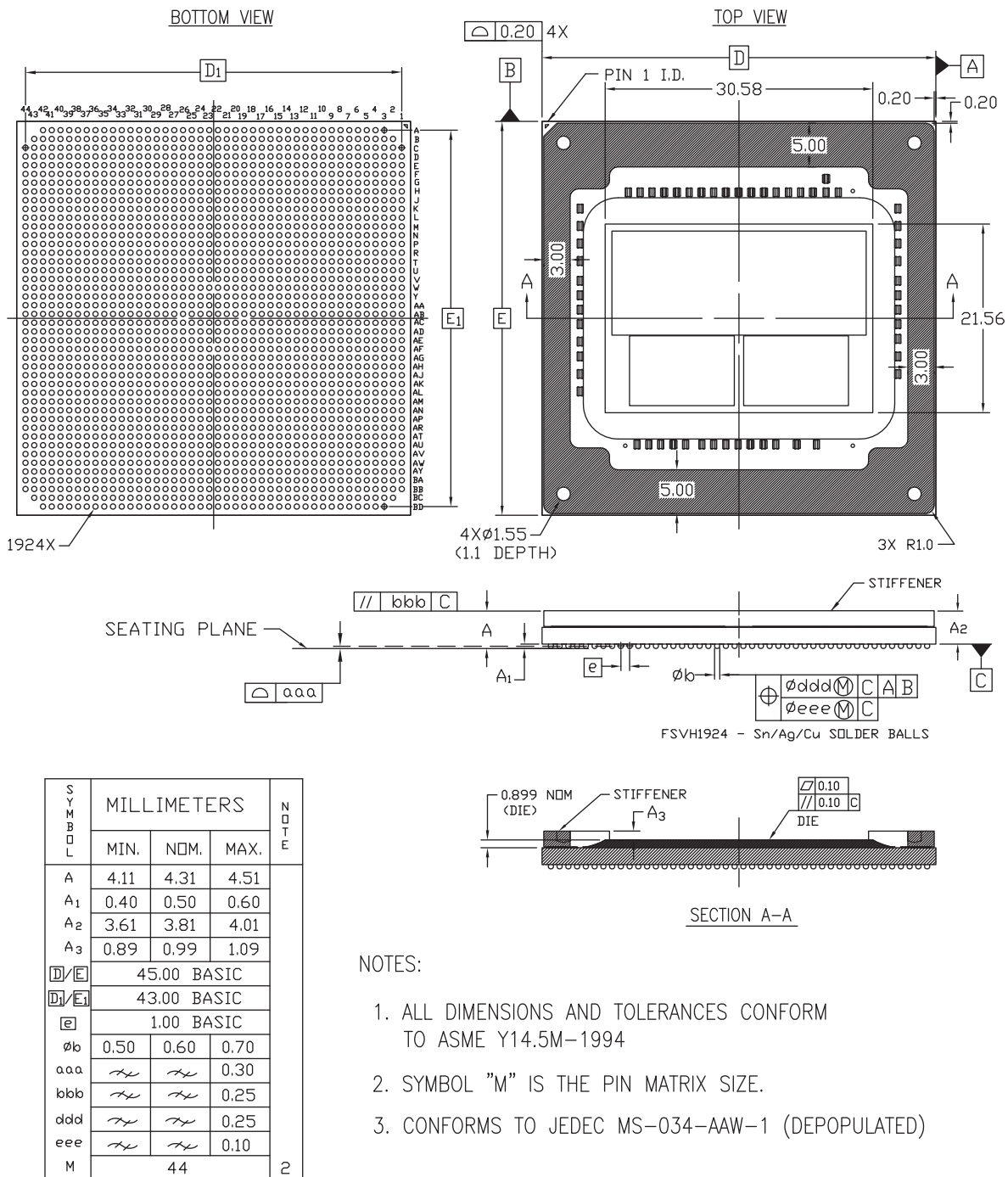

Figure 4-30: Package Dimensions for FSVH1924 (XCVU31P)

FFVA2104 (XCVU080 and XCVU095) and FFVB2104 (XCKU095, XCVU080, and XCVU095) Flip-Chip, Fine-Pitch BGA

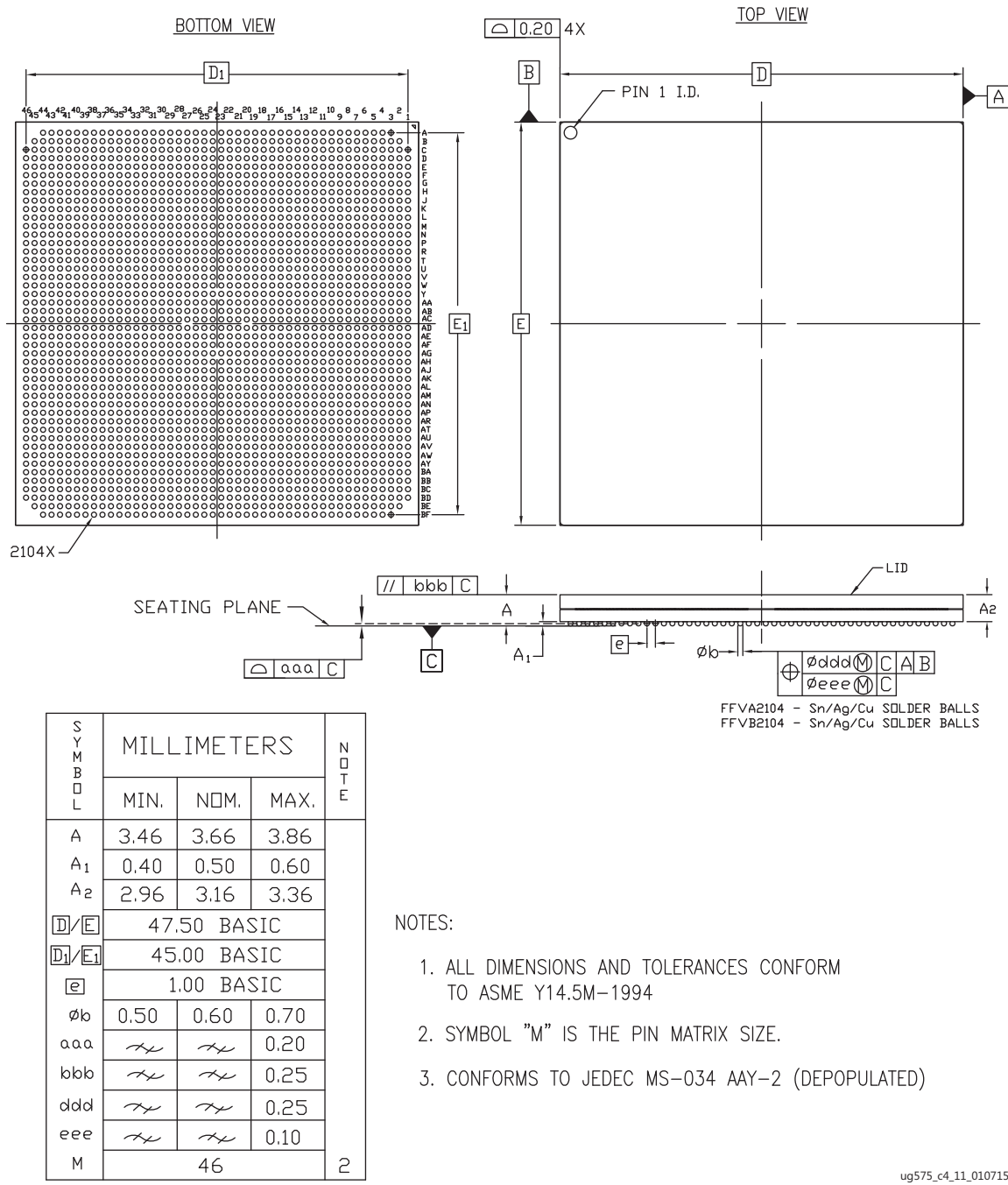
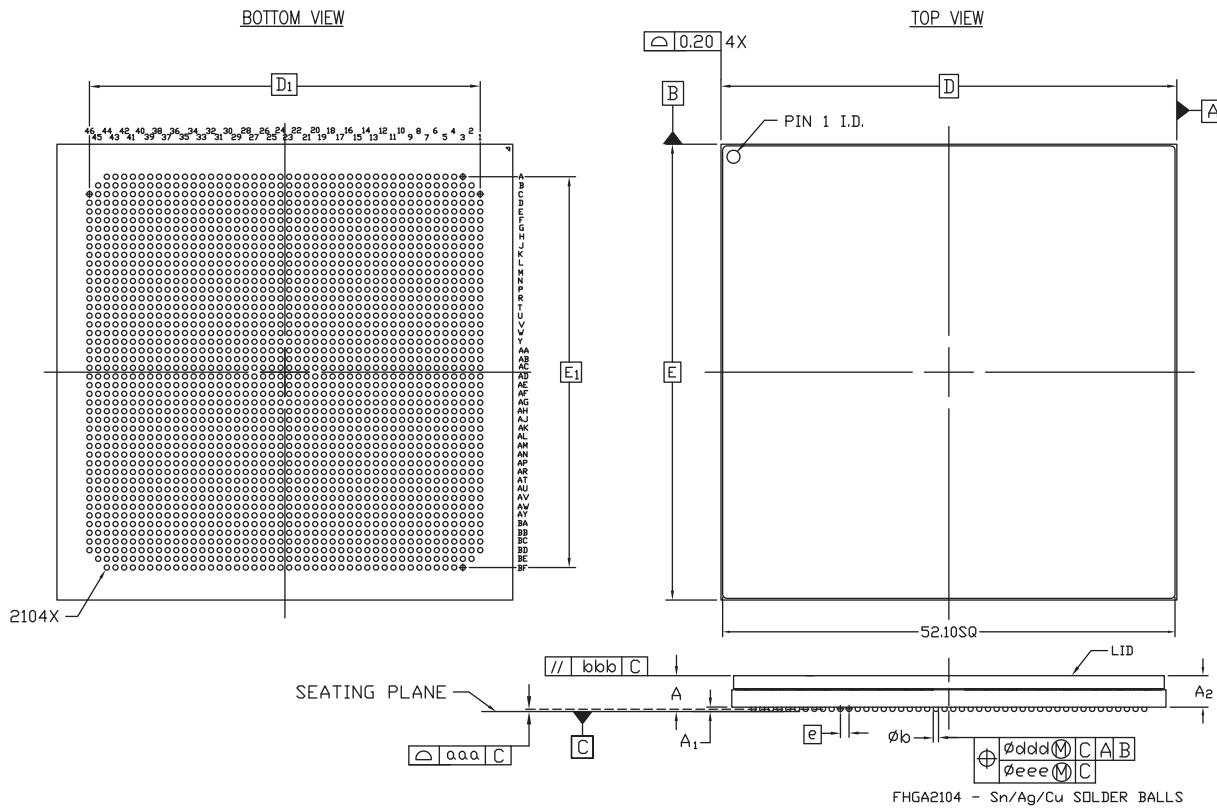

Figure 4-31: Package Dimensions for FFVA2104 (XCVU080, and XCVU095) and FFVB2104 (XCKU095, XCVU080, and XCVU095)

FHGA2104 (XCVU13P) Flip-Chip, Fine-Pitch BGA



SYMBOL	MILLIMETERS			NOTE
	MIN.	NOM.	MAX.	
A	3.84	4.04	4.24	
A ₁	0.40	0.50	0.60	
A ₂	3.34	3.54	3.74	
D/E	52.50 BASIC			
D ₁ /E ₁	45.00 BASIC			
e	1.00 BASIC			
φb	0.50	0.60	0.70	
aaa	<i>∅</i>	<i>∅</i>	0.30	
bbb	<i>∅</i>	<i>∅</i>	0.25	
ddd	<i>∅</i>	<i>∅</i>	0.25	
eee	<i>∅</i>	<i>∅</i>	0.10	
M	46			2

NOTES:

1. ALL DIMENSIONS AND TOLERANCES CONFORM TO ASME Y14.5M-1994
2. SYMBOL "M" IS THE PIN MATRIX SIZE.
3. CONFORMS TO JEDEC MS-034-ABF-2 (DEPOPULATED) EXCEPT FOR DIMENSION "aaa"

ug575_c4_fhga2104_vu13p_041917

Figure 4-32: Package Dimensions for FHGA2104 (XCVU13P)

FHGB2104 (XCVU13P) and FHGC2104 (XCVU13P) Flip-Chip, Fine-Pitch BGA

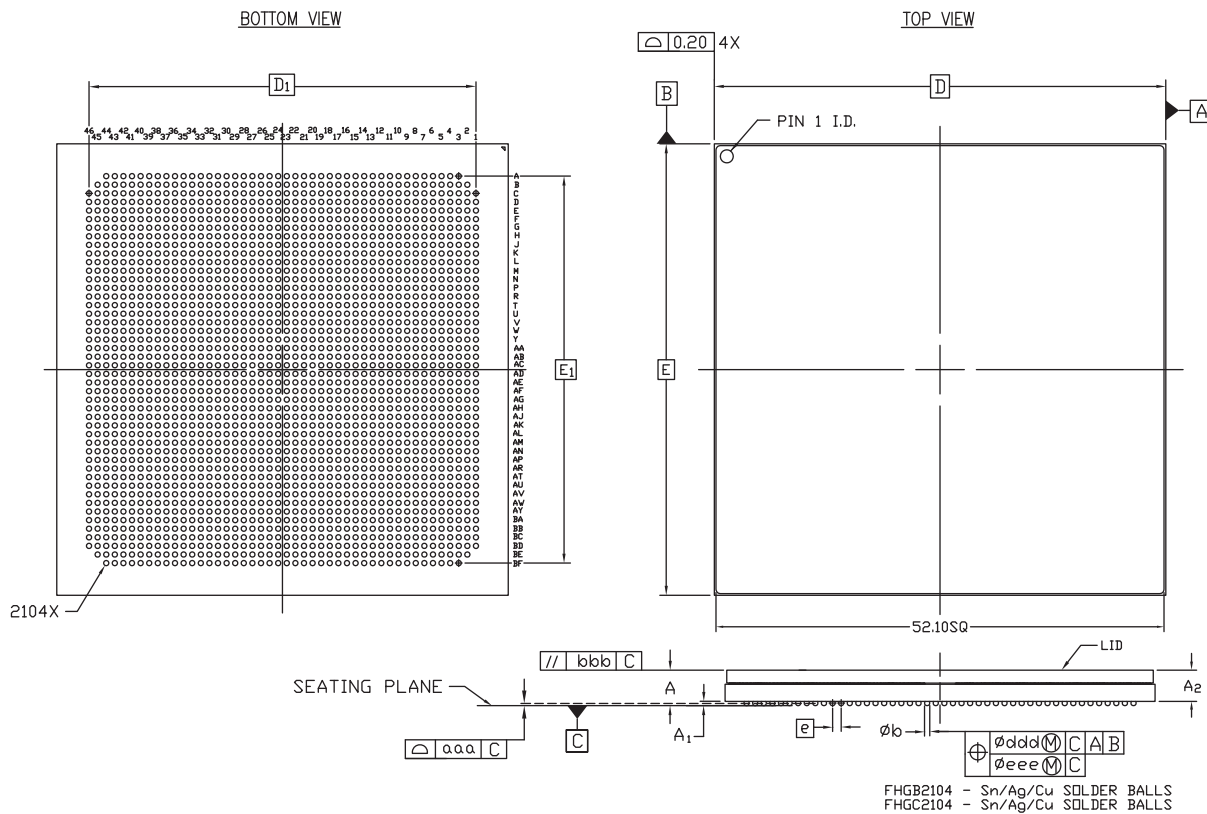

SYMBOL	MILLIMETERS			NOTE
	MIN.	NOM.	MAX.	
A	3.92	4.12	4.32	
A ₁	0.40	0.50	0.60	
A ₂	3.42	3.62	3.82	
D/E	52.50 BASIC			
D ₁ /E ₁	45.00 BASIC			
e	1.00 BASIC			
⌀b	0.50	0.60	0.70	
aaa	$\sqrt{\hspace{1cm}}$	$\sqrt{\hspace{1cm}}$	0.30	
bbb	$\sqrt{\hspace{1cm}}$	$\sqrt{\hspace{1cm}}$	0.25	
ddd	$\sqrt{\hspace{1cm}}$	$\sqrt{\hspace{1cm}}$	0.25	
eee	$\sqrt{\hspace{1cm}}$	$\sqrt{\hspace{1cm}}$	0.10	
M	46			2

NOTES:

1. ALL DIMENSIONS AND TOLERANCES CONFORM TO ASME Y14.5M-1994
2. SYMBOL "M" IS THE PIN MATRIX SIZE.
3. CONFORMS TO JEDEC MS-034-ABF-2 (DEPOPULATED) EXCEPT FOR DIMENSION "aaa"

ug575_c4_fhgb2104_fhgc2104_vu13p_041917

Figure 4-33: Package Dimensions for FHGB2104 (XCVU13P) and FHGC2104 (XCVU13P)

FLVA2104 (XCKU115 and XCVU125) and FLVB2104 (XCKU115 and XCVU125) Flip-Chip, Fine-Pitch BGA

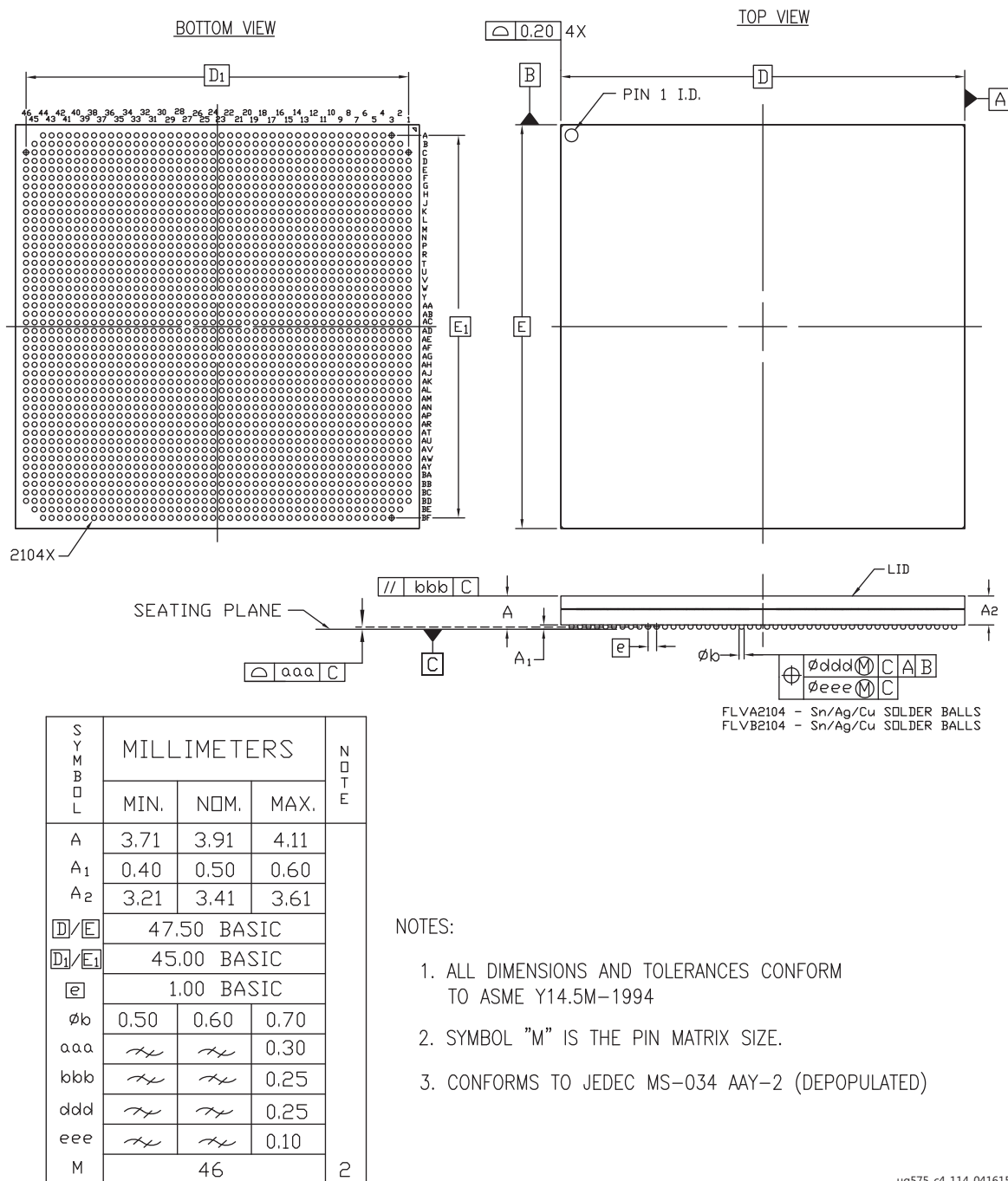

Figure 4-34: Package Dimensions for FLVA2104 (XCKU115 and XCVU125) and FLVB2104 (XCKU115 and XCVU125)

FLVA2104 (XCVU5P and XCVU7P) and FLVB2104 (XCVU5P and XCVU7P) Flip-Chip, Fine-Pitch BGA

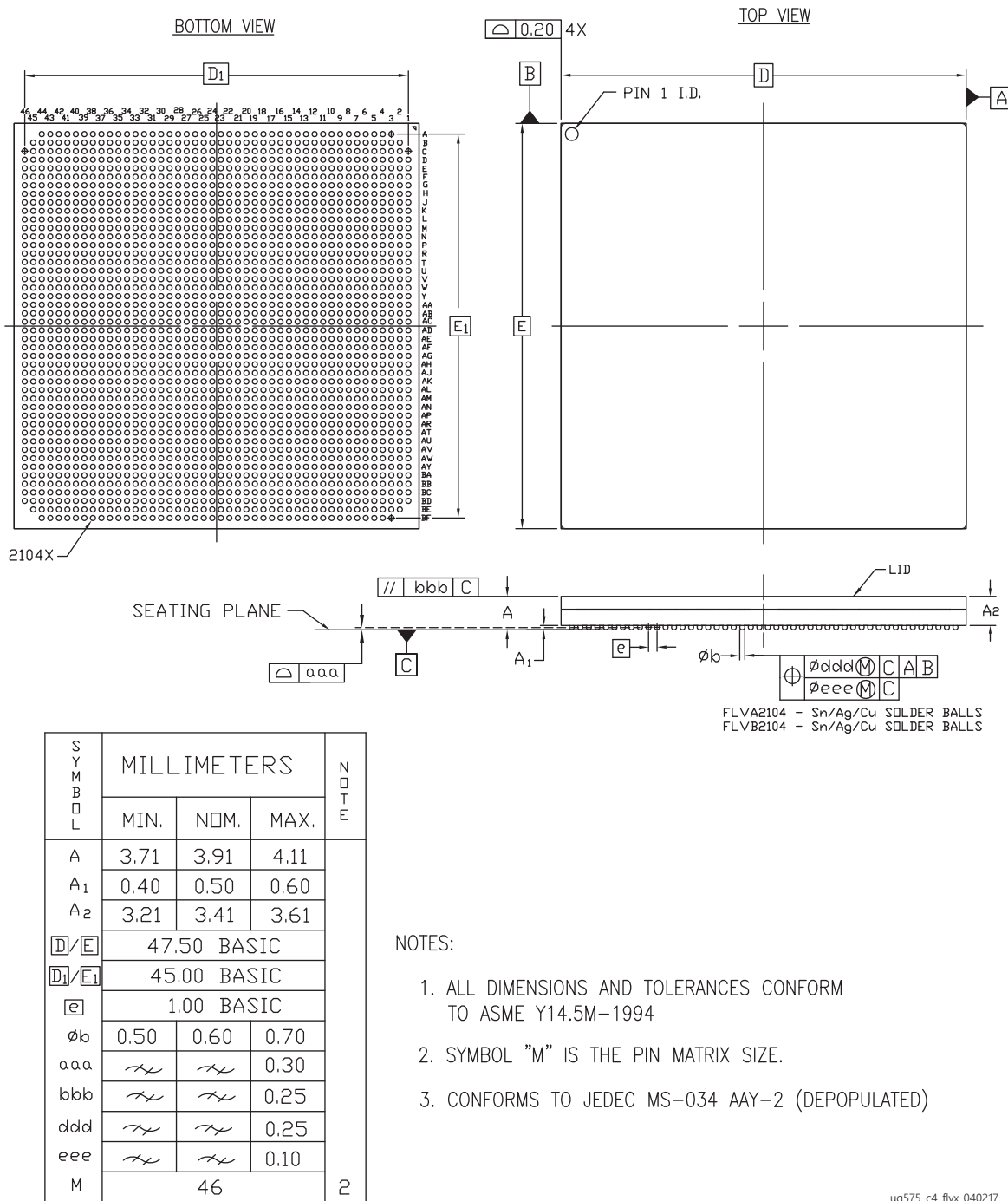

Figure 4-35: Package Dimensions for FLVA2104 (XCVU5P and XCVU7P) and FLVB2104 (XCVU5P and XCVU7P)

FLRA2104 (XQVU7P) and FLRB2104 (XQVU7P) Ruggedized Flip-Chip, Fine-Pitch BGA

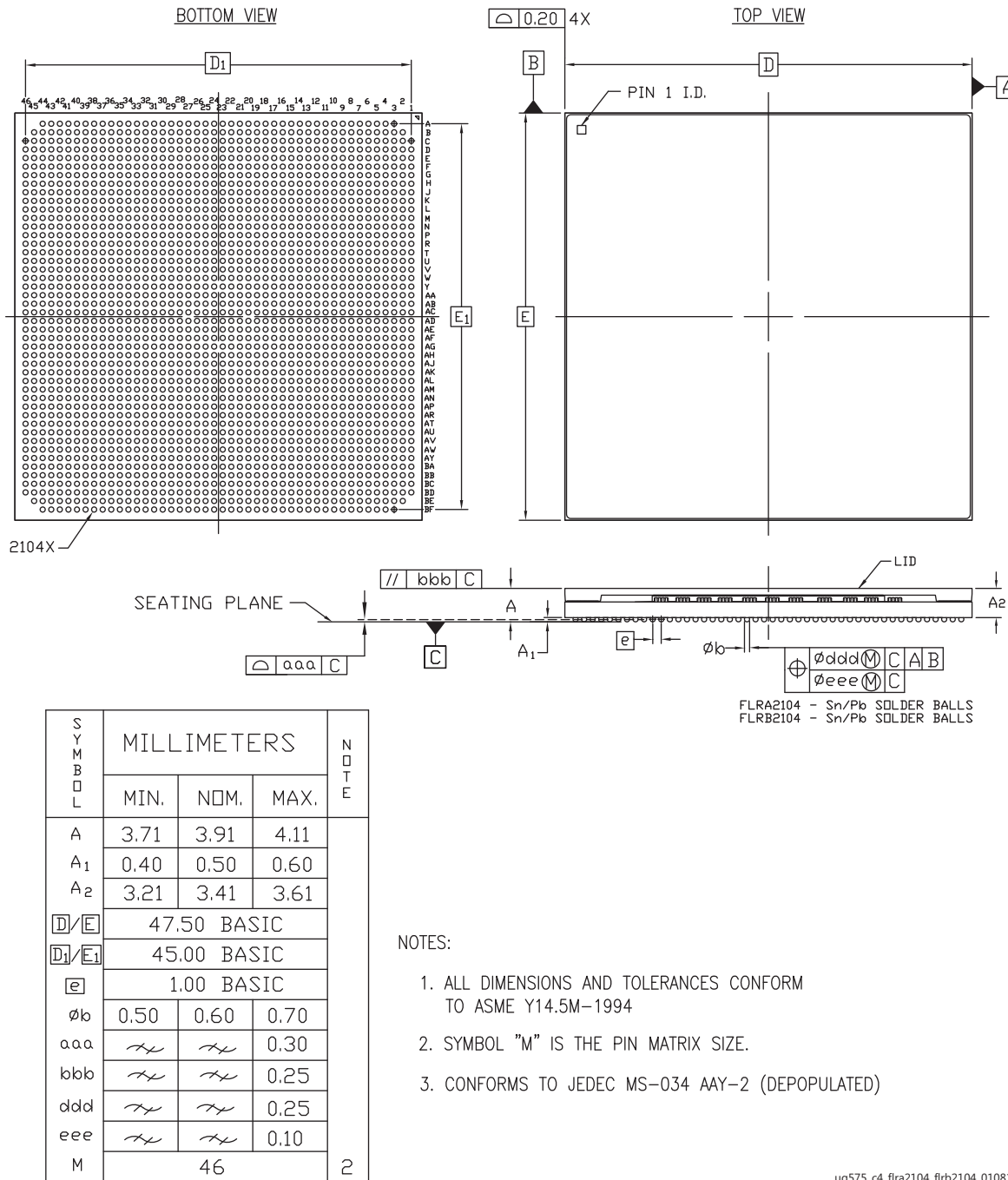
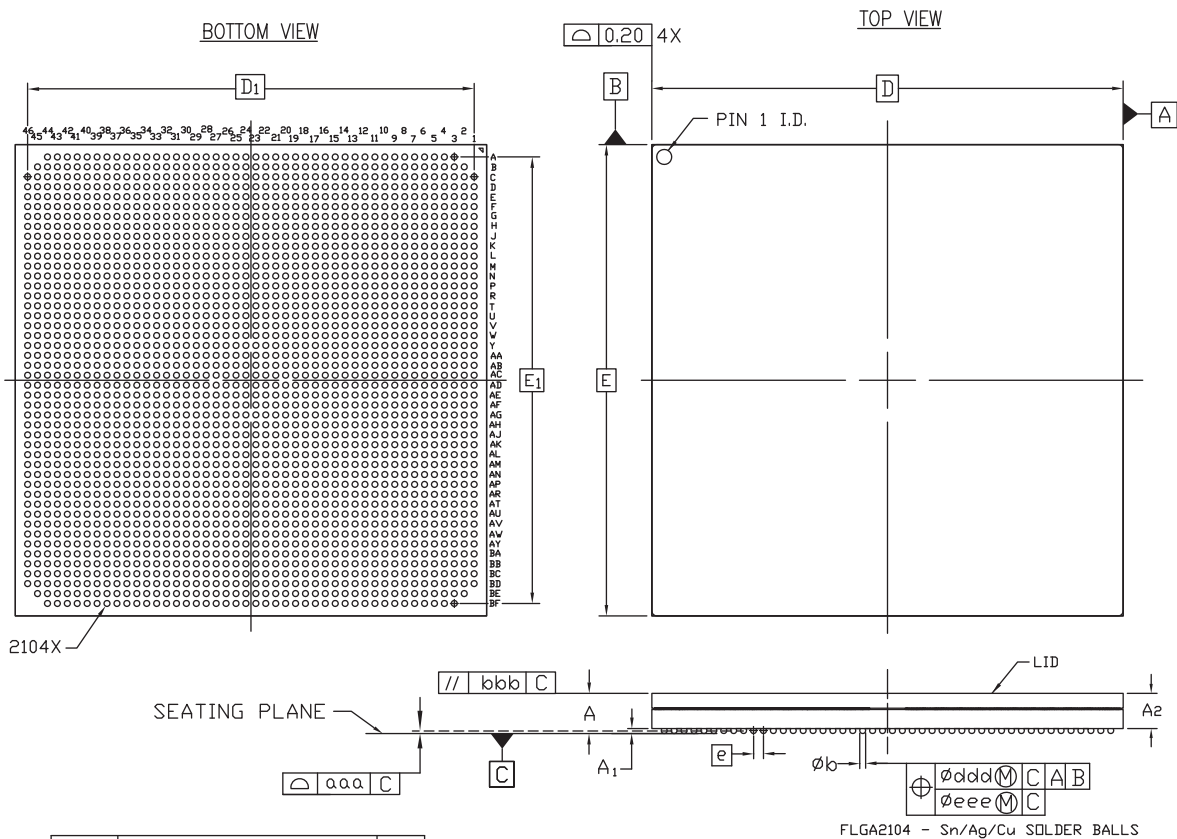

Figure 4-36: Package Dimensions for FLRA2104 (XQVU7P) and FLRB2104 (XQVU7P)

FLGA2104 (XCVU9P) Flip-Chip, Fine-Pitch BGA



SYMBOL	MILLIMETERS			NOTE
	MIN.	NOM.	MAX.	
A	3.84	4.04	4.24	2
A ₁	0.40	0.50	0.60	
A ₂	3.34	3.54	3.74	
D/E	47.50 BASIC			
D ₁ /E ₁	45.00 BASIC			
e	1.00 BASIC			
ϕb	0.50	0.60	0.70	
aaa	$\cancel{\text{---}}$	$\cancel{\text{---}}$	0.30	
bbb	$\cancel{\text{---}}$	$\cancel{\text{---}}$	0.25	
ddd	$\cancel{\text{---}}$	$\cancel{\text{---}}$	0.25	
eee	$\cancel{\text{---}}$	$\cancel{\text{---}}$	0.10	
M	46			

NOTES:

1. ALL DIMENSIONS AND TOLERANCES CONFORM TO ASME Y14.5M-1994
2. SYMBOL "M" IS THE PIN MATRIX SIZE.
3. CONFORMS TO JEDEC MS-034 AAY-2 (DEPOPULATED)

ug575_c4_flg2104_040217

Figure 4-37: Package Dimensions for FLGA2104 (XCVU9P)

FLGB2104 (XCVU160 and XCVU190) and FLGC2104 (XCVU160 and XCVU190) Flip-Chip, Fine-Pitch BGA

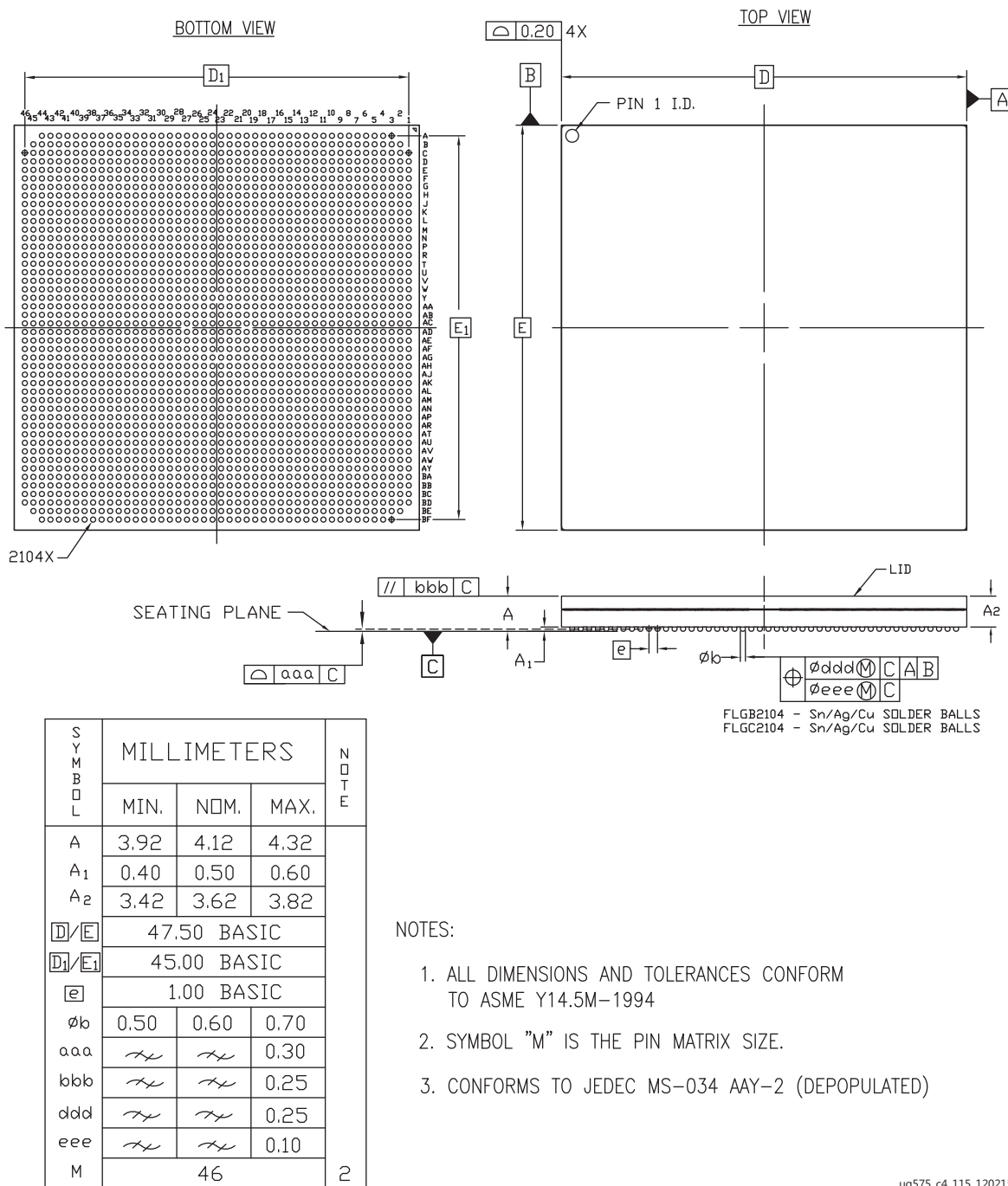

Figure 4-38: Package Dimensions for FLGB2104 (XCVU160 and XCVU190) and FLGC2104 (XCVU160 and XCVU190)

FLGB2104 (XCVU9P and XCVU11P) and FLGC2104 (XCVU11P) Flip-Chip, Fine-Pitch BGA

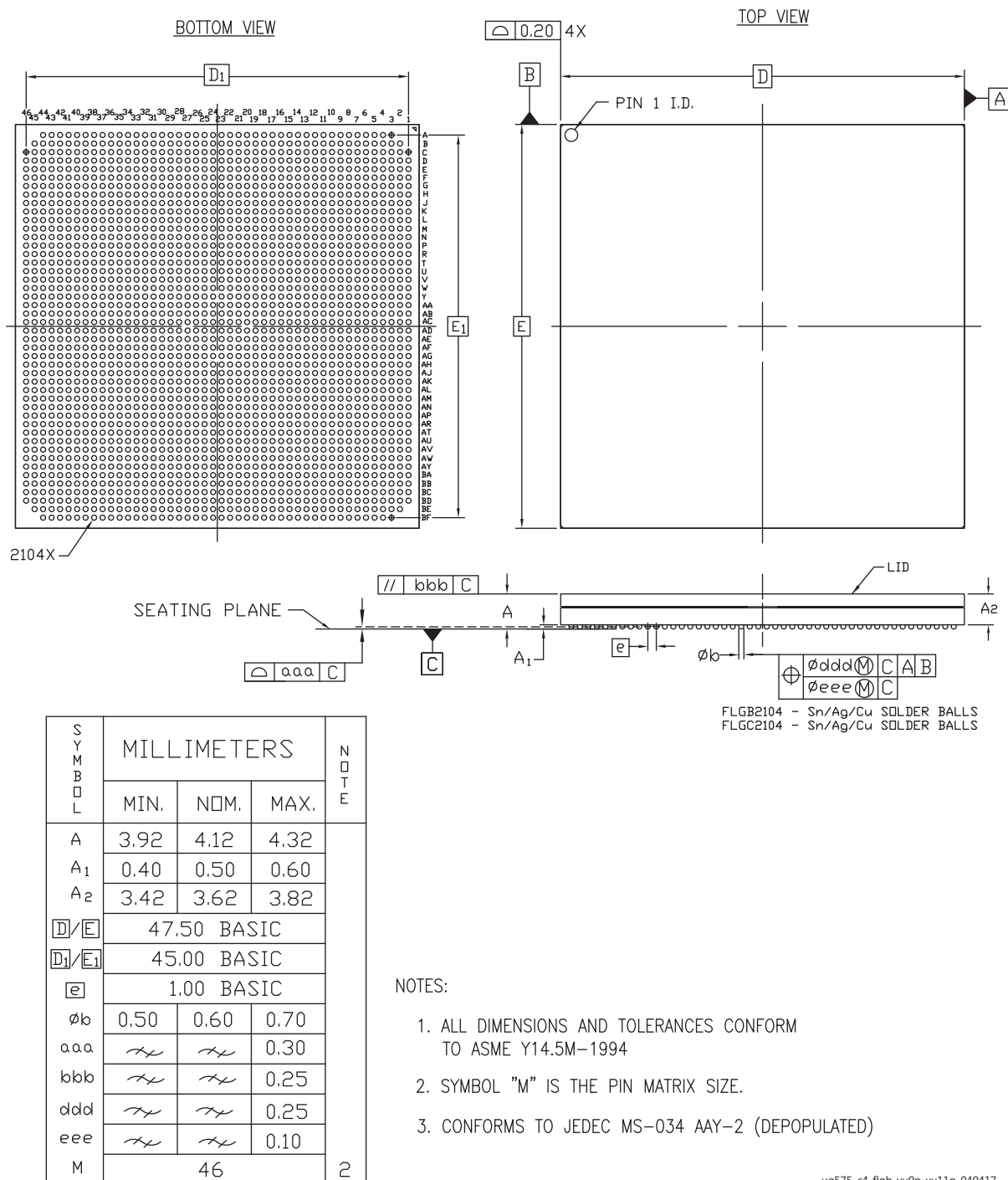
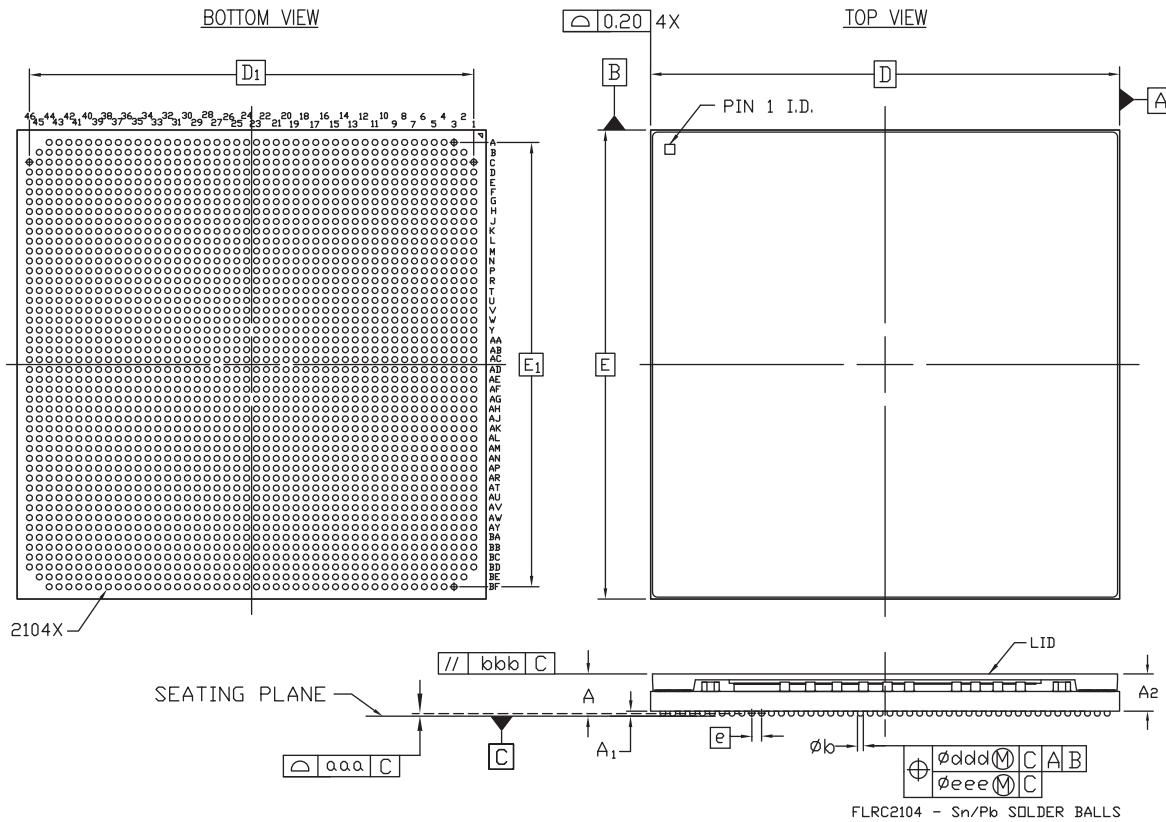

Figure 4-39: Package Dimensions for FLGB2104 (XCVU9P and XCVU11P) and FLGC2104 (XCVU11P)

ug575_c4_flg_bvu9p_vu11p_040417

FLRC2104 (XQVU11P) Ruggedized Flip-Chip, Fine-Pitch BGA



SYMBOL	MILLIMETERS			NOTE
	MIN.	NOM.	MAX.	
A	4.07	4.27	4.47	
A ₁	0.40	0.50	0.60	
A ₂	3.57	3.77	3.97	
D/E	47.50 BASIC			2
D ₁ /E ₁	45.00 BASIC			
e	1.00 BASIC			
phi b	0.50	0.60	0.70	
aaa	$\cancel{\text{---}}$	$\cancel{\text{---}}$	0.30	
bbb	$\cancel{\text{---}}$	$\cancel{\text{---}}$	0.25	
ddd	$\cancel{\text{---}}$	$\cancel{\text{---}}$	0.25	
eee	$\cancel{\text{---}}$	$\cancel{\text{---}}$	0.10	
M	46			

NOTES:

1. ALL DIMENSIONS AND TOLERANCES CONFORM TO ASME Y14.5M-1994
2. SYMBOL "M" IS THE PIN MATRIX SIZE.
3. CONFORMS TO JEDEC MS-034 AAY-2 (DEPOPULATED)

ug575_c4_firc2104_010819

Figure 4-40: Package Dimensions for FLRC2104 (XQVU11P)

FFVC2104 (XCVU095) Flip-Chip, Fine-Pitch BGA

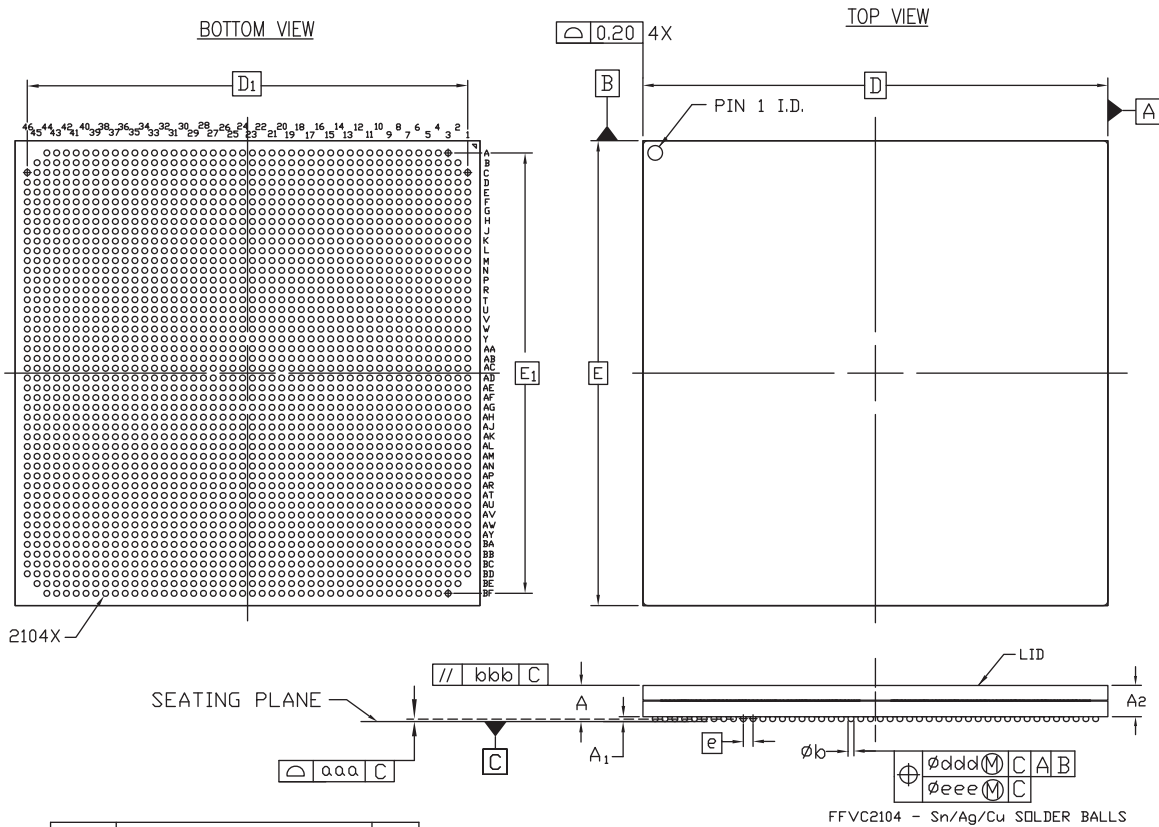

FFVC2104 - Sn/Ag/Cu SOLDER BALLS

SYMBOL	MILLIMETERS			NOTE
	MIN.	NOM.	MAX.	
A	3.64	3.84	4.04	
A ₁	0.40	0.50	0.60	
A ₂	3.14	3.34	3.54	
D/E	47.50 BASIC			
D ₁ /E ₁	45.00 BASIC			
e	1.00 BASIC			
øb	0.50	0.60	0.70	
aaa	<i>xx</i>	<i>xx</i>	0.20	
bbb	<i>xx</i>	<i>xx</i>	0.25	
ddd	<i>xx</i>	<i>xx</i>	0.25	
eee	<i>xx</i>	<i>xx</i>	0.10	
M	46			2

NOTES:

1. ALL DIMENSIONS AND TOLERANCES CONFORM TO ASME Y14.5M-1994
2. SYMBOL "M" IS THE PIN MATRIX SIZE.
3. CONFORMS TO JEDEC MS-034 AAY-2 (DEPOPULATED)

ug575_c4_18_041716

Figure 4-41: Package Dimensions for FFVC2104 (XCVU095)

FLGC2104 (XCVU9P) Flip-Chip, Fine-Pitch BGA

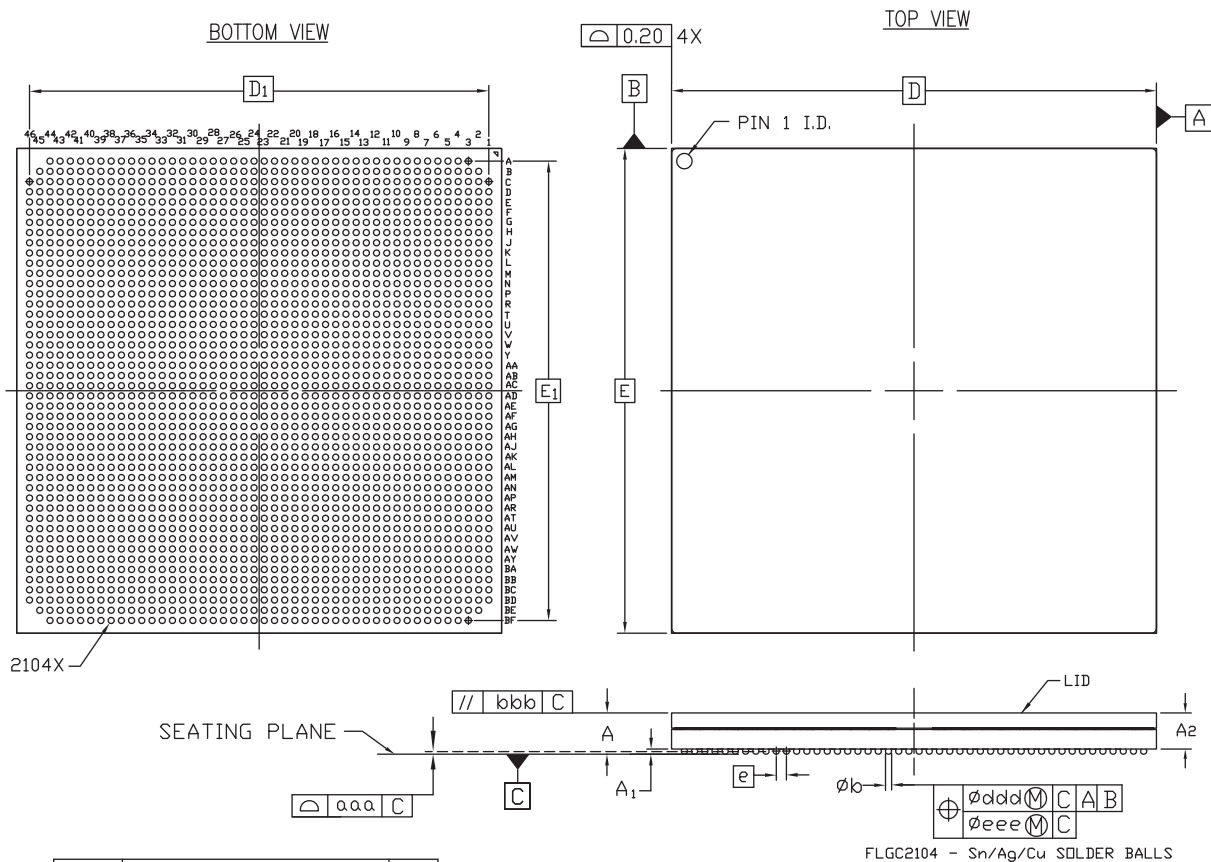

SYMBOL	MILLIMETERS			NOTE
	MIN.	NOM.	MAX.	
A	3.84	4.04	4.24	
A ₁	0.40	0.50	0.60	
A ₂	3.34	3.54	3.74	
D/E	47.50 BASIC			2
D ₁ /E ₁	45.00 BASIC			
e	1.00 BASIC			
øb	0.50	0.60	0.70	
aaa	<i>TL</i>	<i>TL</i>	0.30	
bbb	<i>TL</i>	<i>TL</i>	0.25	
ddd	<i>TL</i>	<i>TL</i>	0.25	
eee	<i>TL</i>	<i>TL</i>	0.10	
M	46			

NOTES:

1. ALL DIMENSIONS AND TOLERANCES CONFORM TO ASME Y14.5M-1994
2. SYMBOL "M" IS THE PIN MATRIX SIZE.
3. CONFORMS TO JEDEC MS-034 AAY-2 (DEPOPULATED)

ug575_c4_flgcvu9p_040417

Figure 4-42: Package Dimensions for FLGC2104 (XCVU9P)

FLVC2104 (XCVU125) Flip-Chip, Fine-Pitch BGA

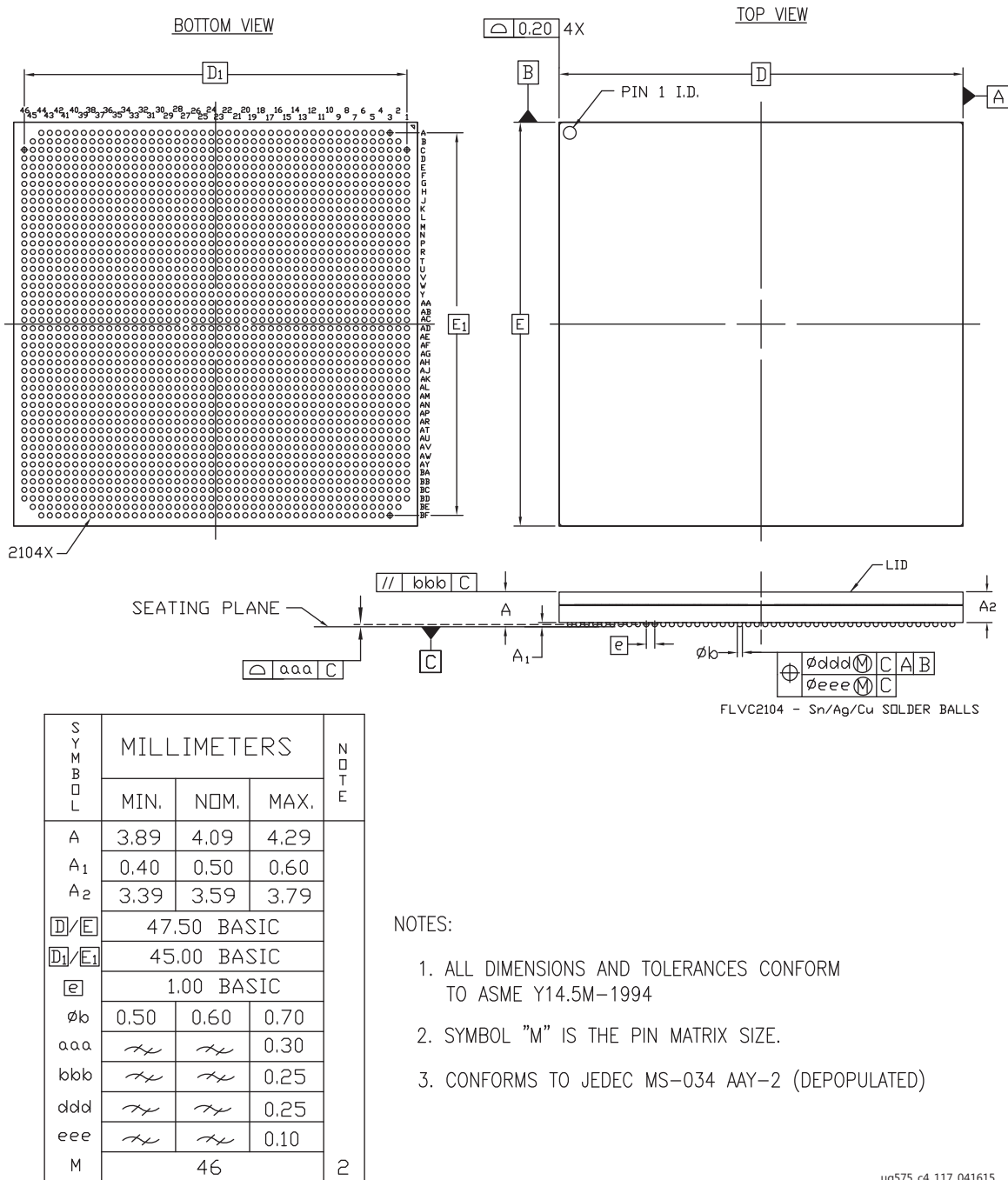

Figure 4-43: Package Dimensions for FLVC2104 (XCVU125)

FLVC2104 (XCVU5P and XCVU7P) Flip-Chip, Fine-Pitch BGA

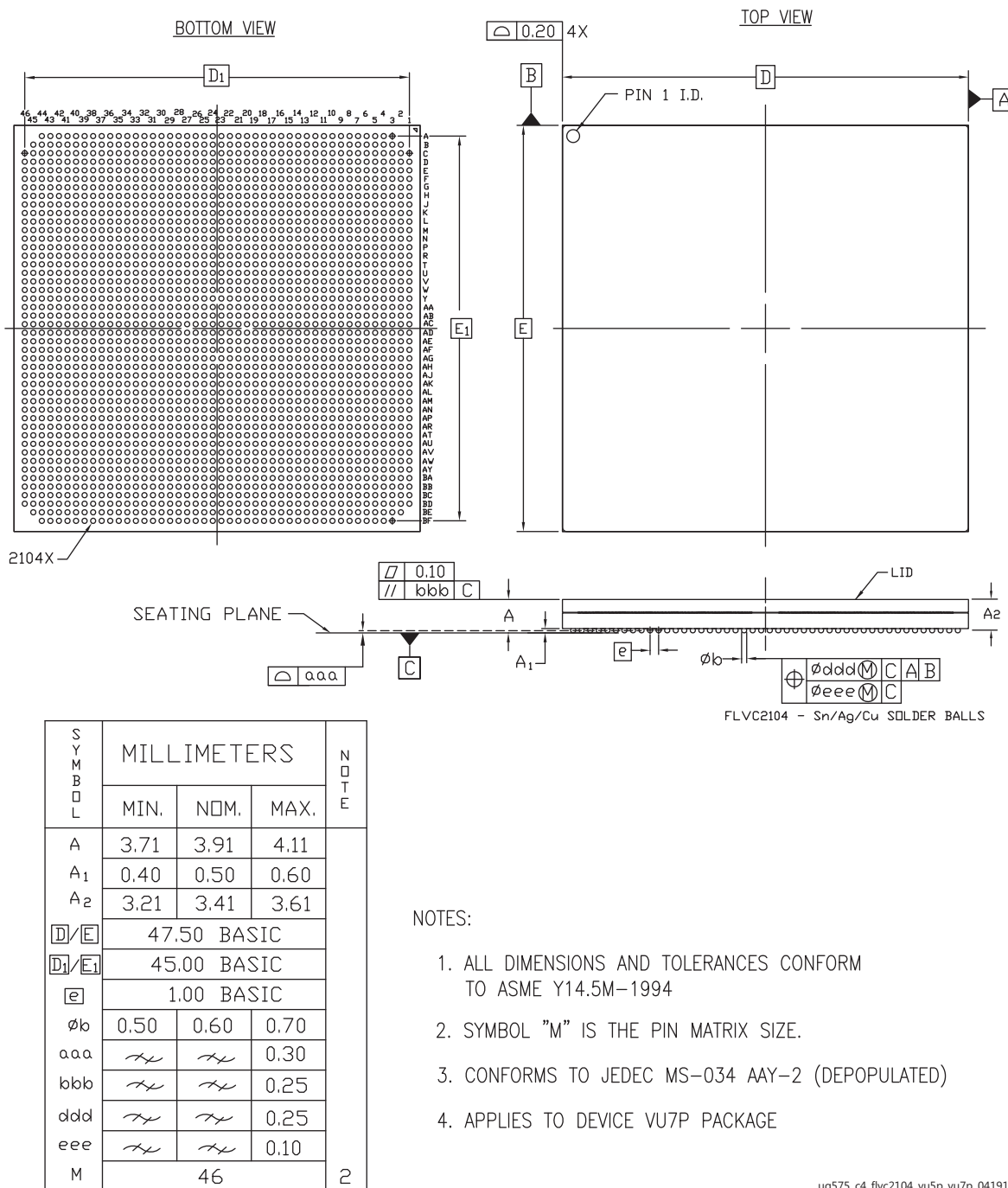
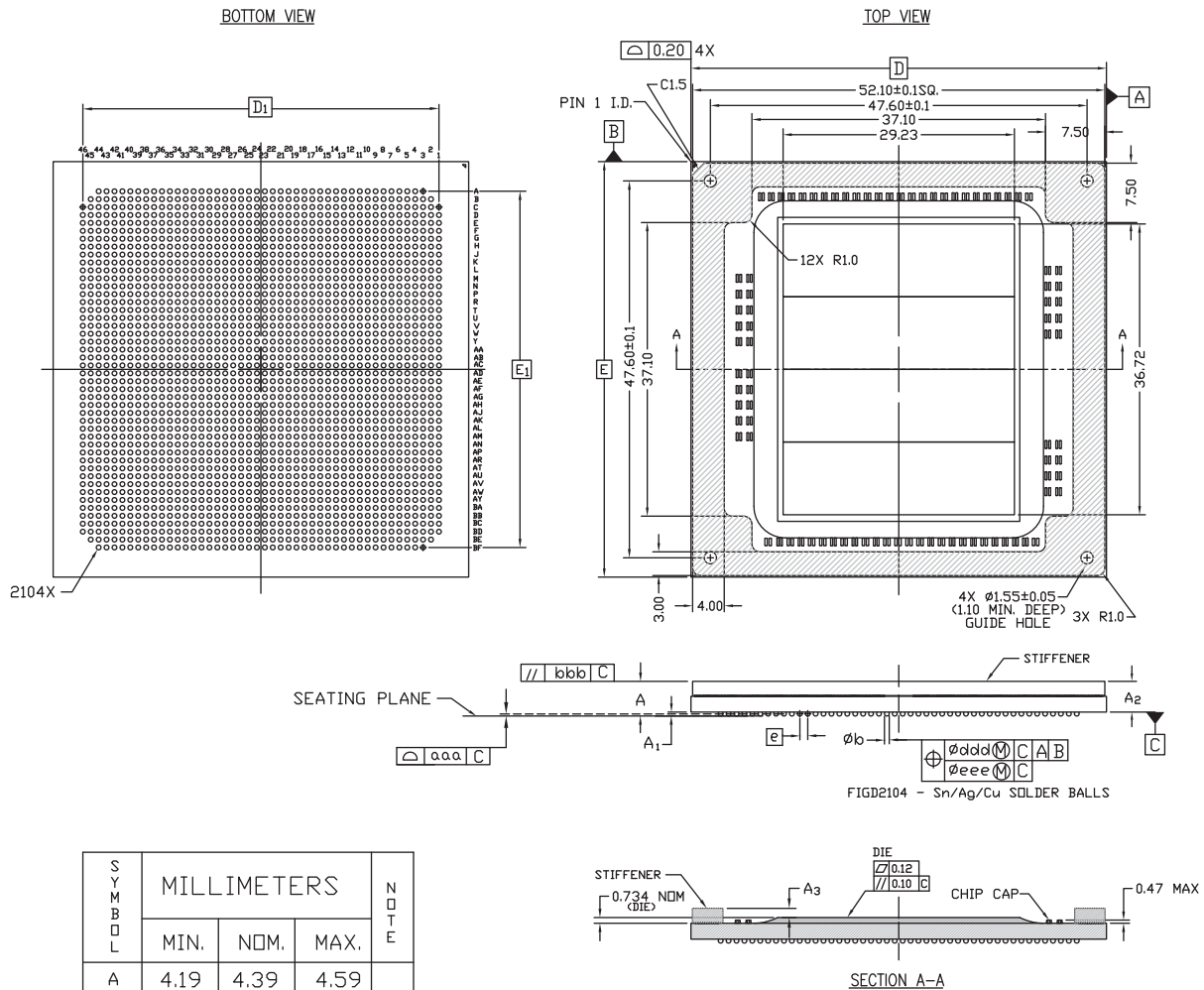

Figure 4-44: Package Dimensions for FLVC2104 (XCVU5P and XCVU7P)

FIGD2104 (XCVU13P, XCVU27P, and XCVU29P) Flip-Chip, Fine-Pitch BGA



SYMBOL	MILLIMETERS			NOTE
	MIN.	NOM.	MAX.	
A	4.19	4.39	4.59	2
A ₁	0.40	0.50	0.60	
A ₂	3.69	3.89	4.09	
A ₃	1.06	1.16	1.26	
D/E	52.50 BASIC			
D ₁ /E ₁	45.00 BASIC			
E	1.00 BASIC			
φ _b	0.50	0.60	0.70	
aaa	<i>TL</i>	<i>TL</i>	0.30	
bbb	<i>TL</i>	<i>TL</i>	0.25	
ddd	<i>TL</i>	<i>TL</i>	0.25	
eee	<i>TL</i>	<i>TL</i>	0.10	
M	46			

NOTES:

1. ALL DIMENSIONS AND TOLERANCES CONFORM TO ASME Y14.5M-1994
2. SYMBOL "M" IS THE PIN MATRIX SIZE.
3. CONFORMS TO JEDEC MS-034-ABF-2 (DEPOPULATED) EXCEPT FOR DIMENSION "aaa"

ug575_c4_vu13P_figd2104_102517

Figure 4-45: Package Dimensions for FIGD2104 (XCVU13P, XCVU27P, and XCVU29P)

FSGD2104 (XCVU9P) Flip-Chip, Fine-Pitch BGA

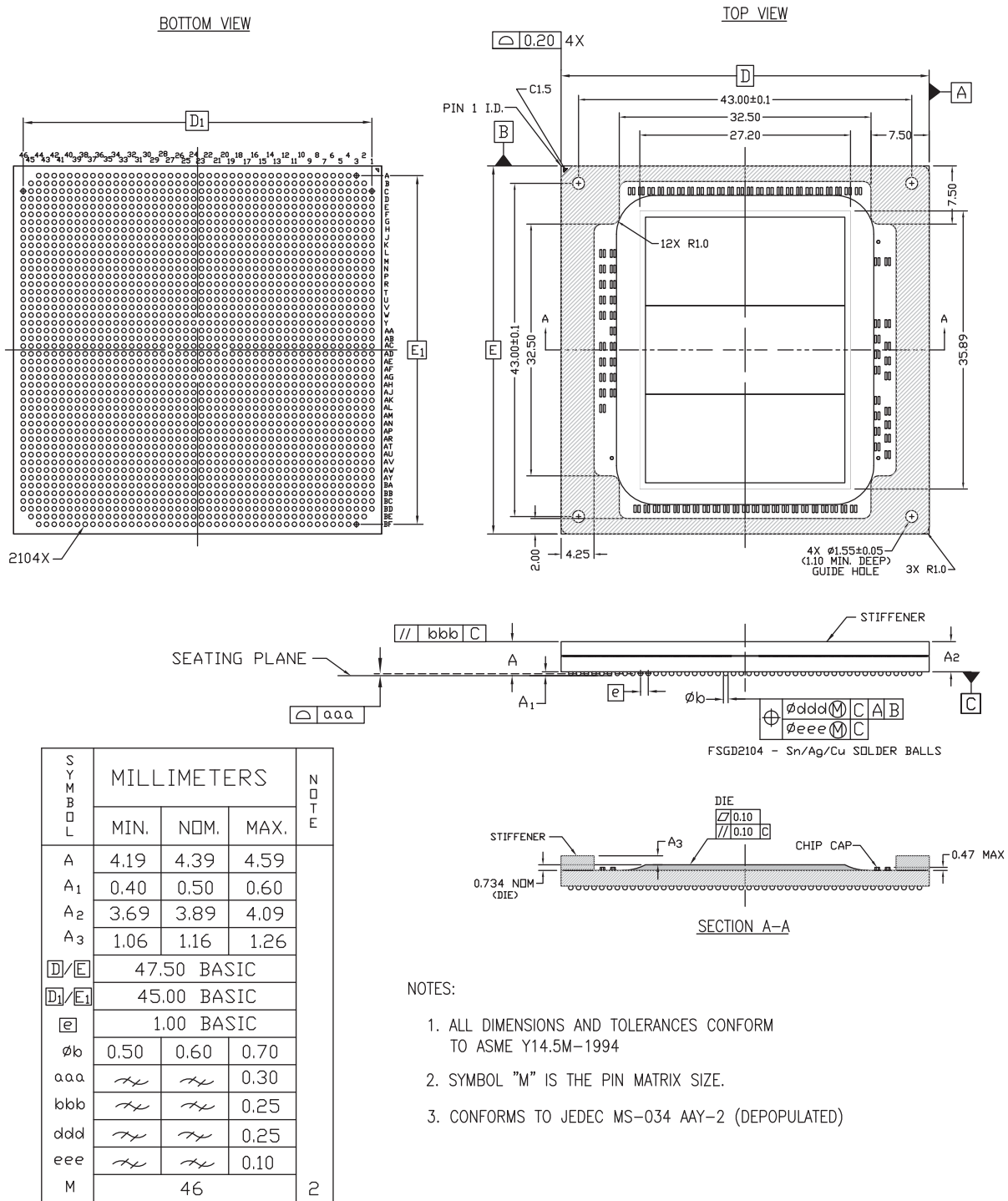

ug575_c4_vu9P_fsgd2104_100717

Figure 4-46: Package Dimensions for FSGD2104 (XCVU9P)

FSGD2104 (XCVU11P) Flip-Chip, Fine-Pitch BGA

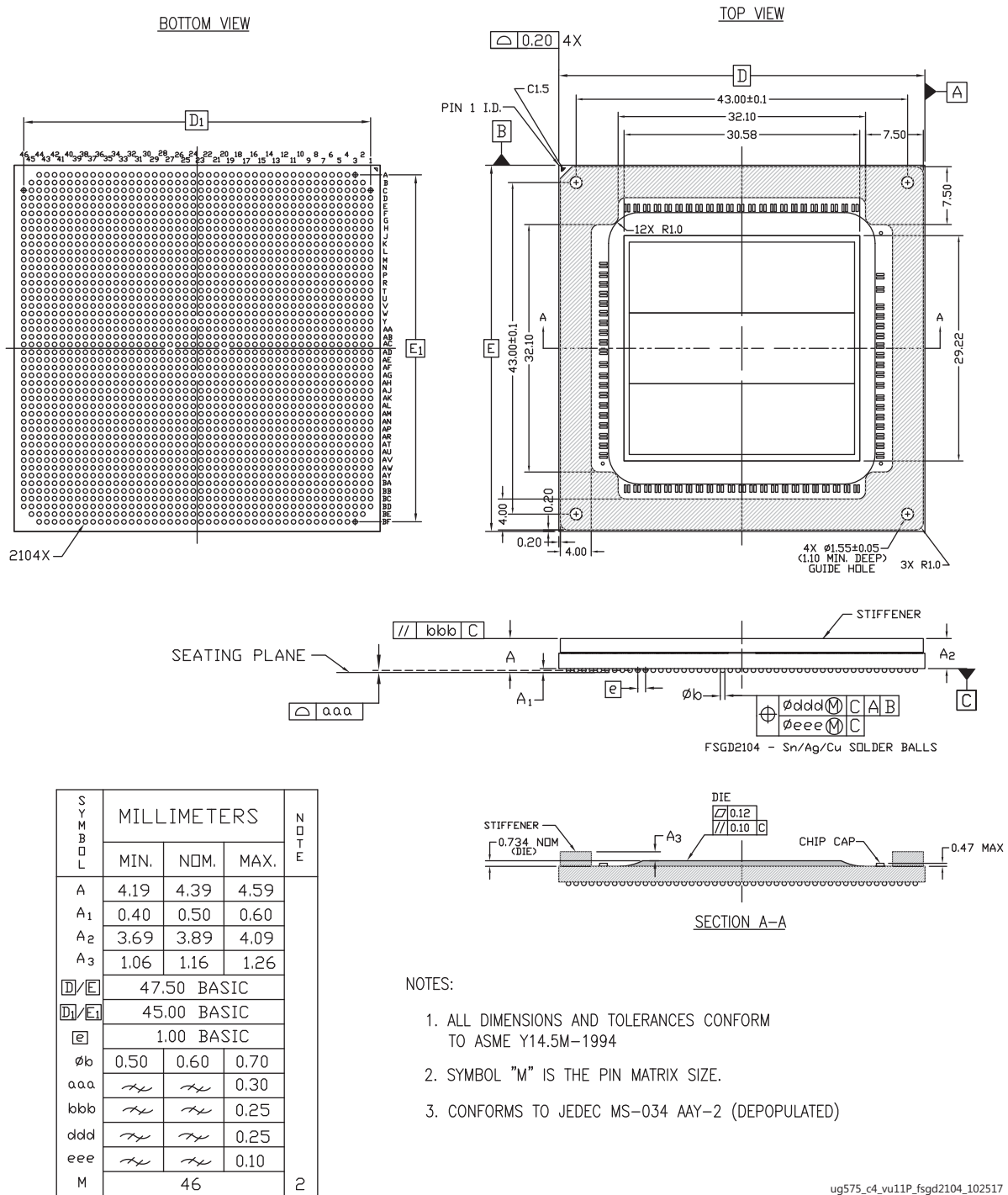

Figure 4-47: Package Dimensions for FSGD2104 (XCVU11P)

FSVH2104 (XCVU33P) Flip-Chip, Fine-Pitch, Lidless with Stiffener Ring, BGA

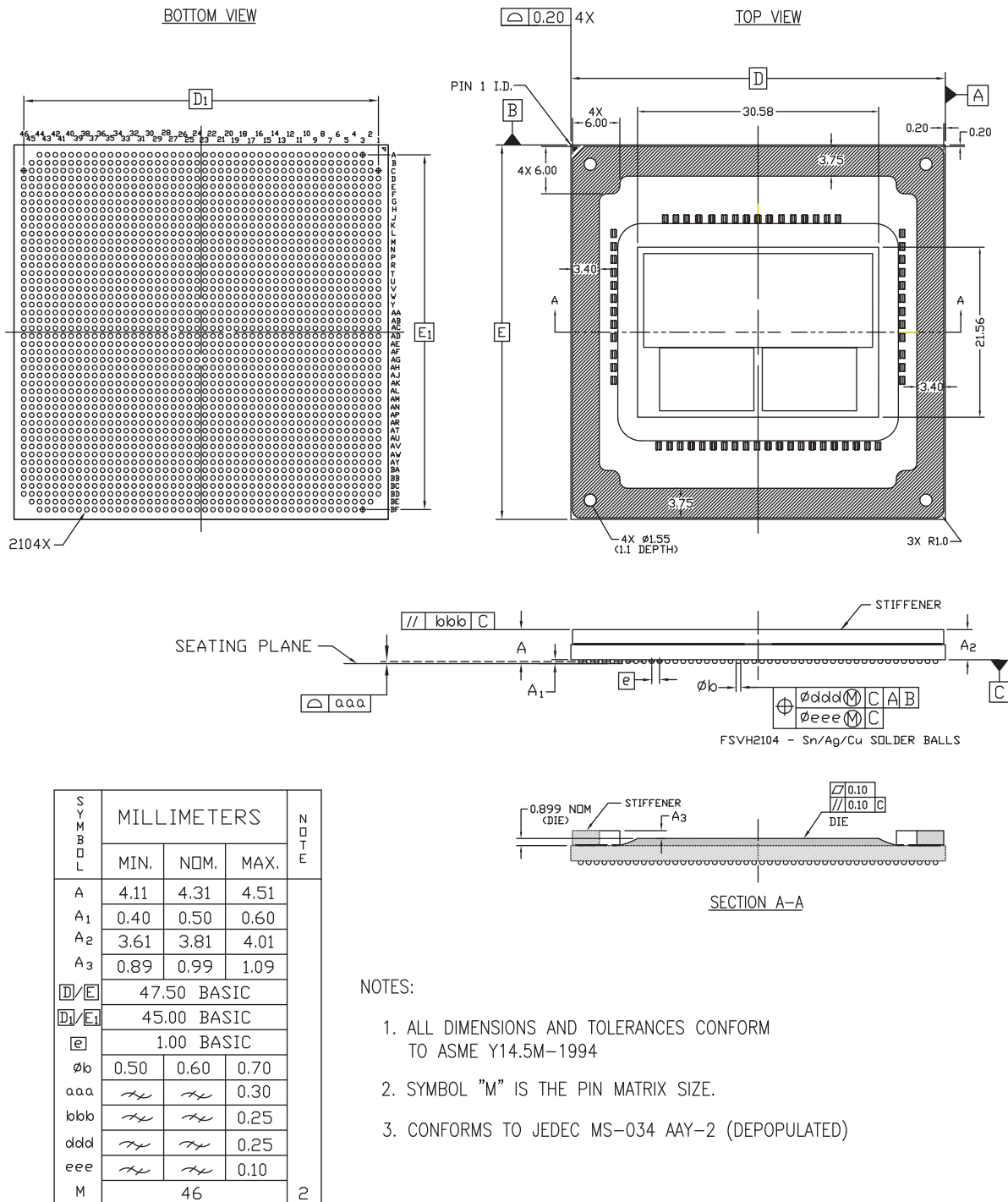

Figure 4-48: Package Dimensions for FSVH2104 (XCVU33P)

FSVH2104 (XCVU35P) Flip-Chip, Fine-Pitch, Lidless with Stiffener Ring, BGA

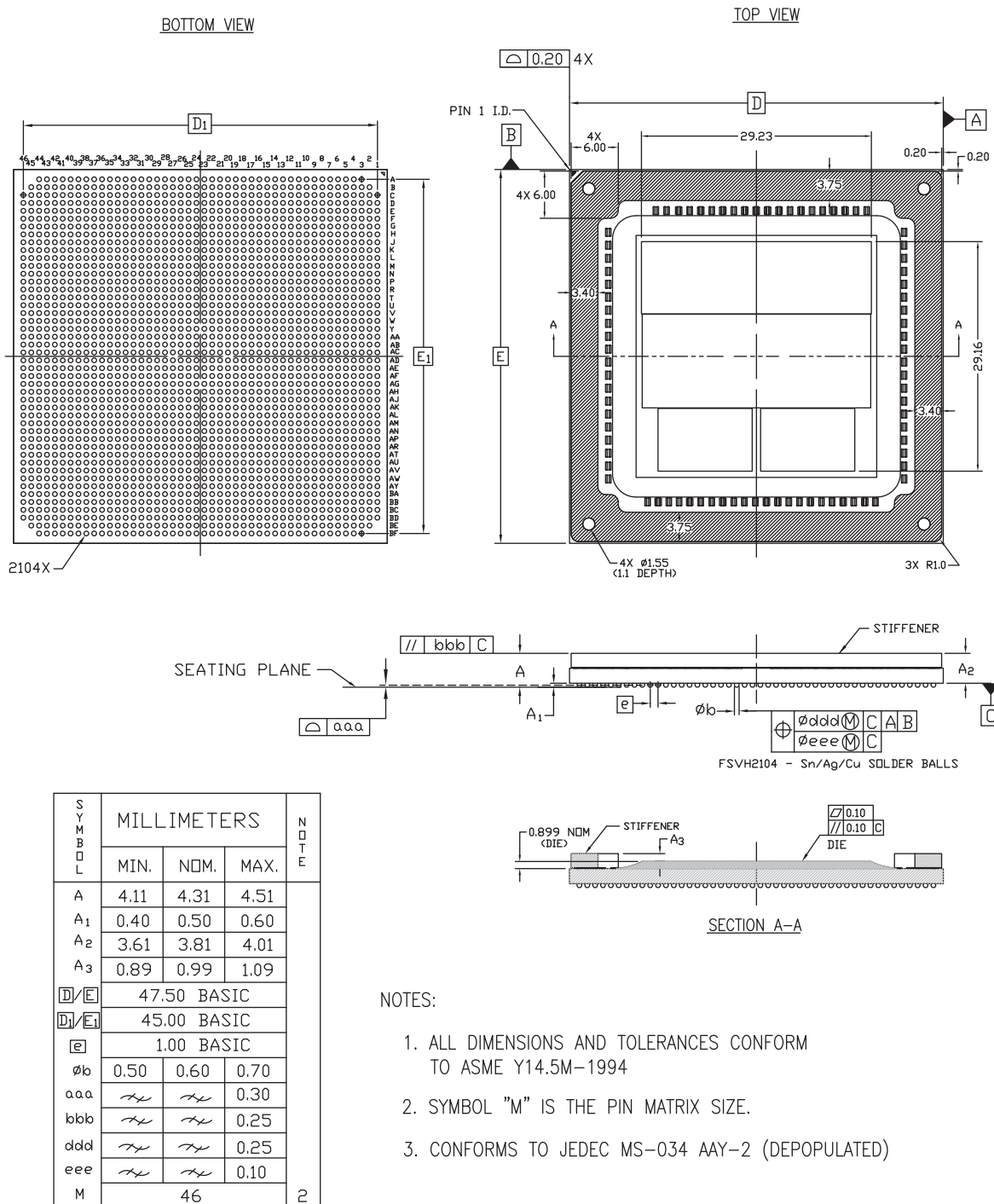
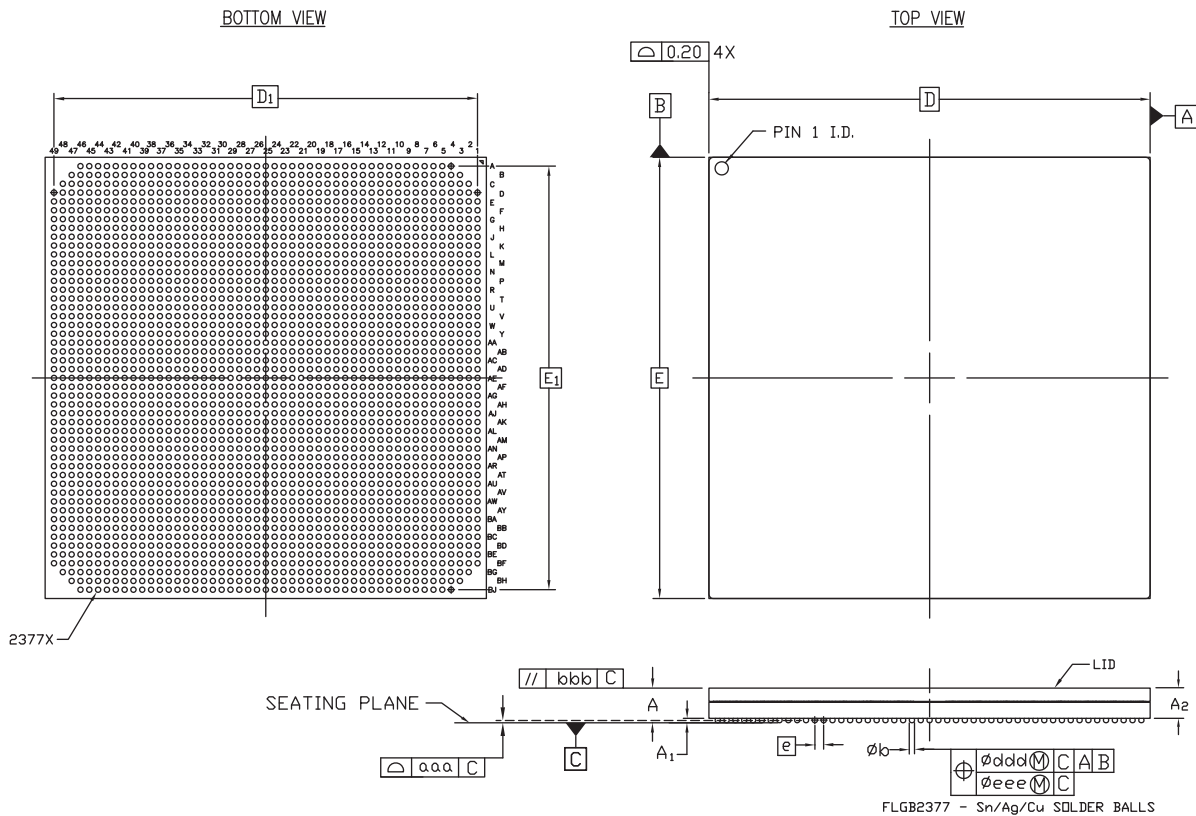

Figure 4-49: Package Dimensions for FSVH2104 (XCVU35P)

FLGB2377 Flip-Chip, Fine-Pitch BGA (XCVU440)



SYMBOL	MILLIMETERS			NOTE
	MIN.	NOM.	MAX.	
A	3.73	3.93	4.13	
A ₁	0.40	0.50	0.60	
A ₂	3.23	3.43	3.63	
D/E	50.00 BASIC			
D ₁ /E ₁	48.00 BASIC			
e	1.00 BASIC			
øb	0.50	0.60	0.70	
aaa	$\cancel{\text{---}}$	$\cancel{\text{---}}$	0.30	
bbb	$\cancel{\text{---}}$	$\cancel{\text{---}}$	0.25	
ddd	$\cancel{\text{---}}$	$\cancel{\text{---}}$	0.25	
eee	$\cancel{\text{---}}$	$\cancel{\text{---}}$	0.10	
M	49			2

NOTES:

1. ALL DIMENSIONS AND TOLERANCES CONFORM TO ASME Y14.5M-1994
2. SYMBOL "M" IS THE PIN MATRIX SIZE
3. CONFORMS TO JEDEC REFERENCE MS-034-ABA-1 (DEPOPULATED) EXCEPT FOR DIMENSION "aaa"

ug575_c4_12_100615

Figure 4-50: Package Dimensions for FLGB2377 (XCVU440)

FLGA2577 Flip-Chip, Fine-Pitch BGA (XCVU190)

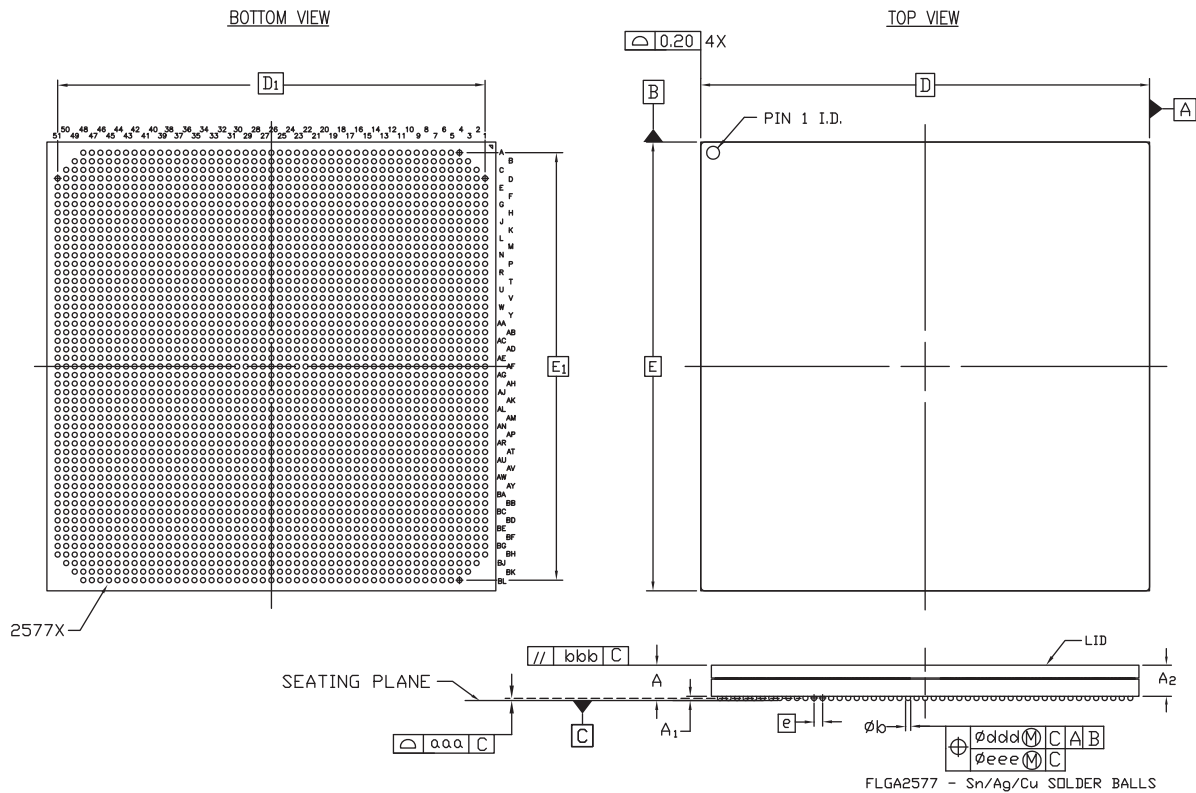

SYMBOL	MILLIMETERS			NOTE
	MIN.	NOM.	MAX.	
A	3.91	4.11	4.31	
A ₁	0.40	0.50	0.60	
A ₂	3.41	3.61	3.81	
D/E	52.50 BASIC			
D ₁ /E ₁	50.00 BASIC			
e	1.00 BASIC			
∅b	0.50	0.60	0.70	
aaa	$\cancel{\text{---}}$	$\cancel{\text{---}}$	0.30	
bbb	$\cancel{\text{---}}$	$\cancel{\text{---}}$	0.25	
ddd	$\cancel{\text{---}}$	$\cancel{\text{---}}$	0.25	
eee	$\cancel{\text{---}}$	$\cancel{\text{---}}$	0.10	
M	51			2

NOTES:

1. ALL DIMENSIONS AND TOLERANCES CONFORM TO ASME Y14.5M-1994
2. SYMBOL "M" IS THE PIN MATRIX SIZE.
3. CONFORMS TO JEDEC MS-034-ABF-2 (DEPOPULATED) EXCEPT FOR DIMENSION "aaa"

ug575_c4_13_101215

Figure 4-51: Package Dimensions for FLGA2577 (XCVU190)

FLGA2577 Flip-Chip, Fine-Pitch BGA (XCVU9P and XCVU13P)

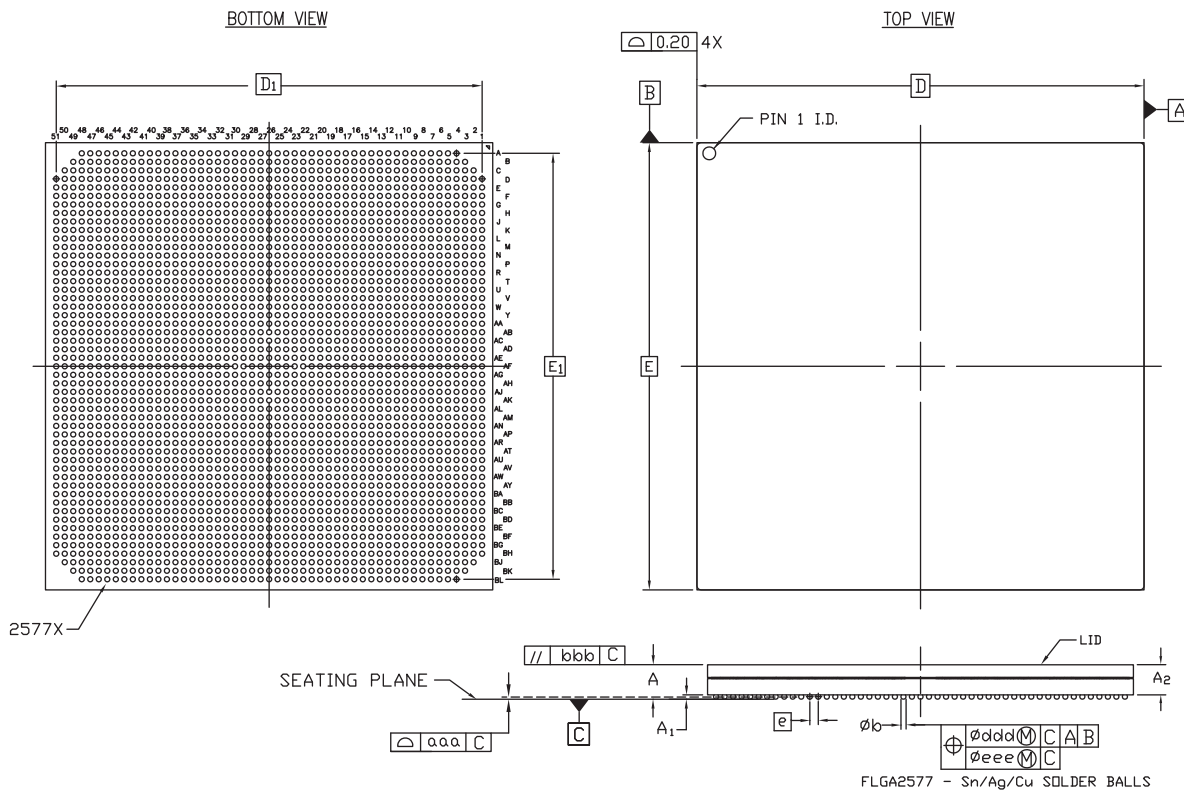

SYMBOL	MILLIMETERS			NOTE
	MIN.	NOM.	MAX.	
A	3.84	4.04	4.24	
A ₁	0.40	0.50	0.60	
A ₂	3.34	3.54	3.74	
D/E	52.50 BASIC			
D ₁ /E ₁	50.00 BASIC			
e	1.00 BASIC			
øb	0.50	0.60	0.70	
aaa	<i>h</i>	<i>h</i>	0.30	
bbb	<i>h</i>	<i>h</i>	0.25	
ddd	<i>h</i>	<i>h</i>	0.25	
eee	<i>h</i>	<i>h</i>	0.10	
M	51			2

NOTES:

1. ALL DIMENSIONS AND TOLERANCES CONFORM TO ASME Y14.5M-1994
2. SYMBOL "M" IS THE PIN MATRIX SIZE.
3. CONFORMS TO JEDEC MS-034-ABF-2 (DEPOPULATED) EXCEPT FOR DIMENSION "aaa"
4. THIS PACKAGE APPLIES TO UltraScale+ XCVU9P & XCVU13P DEVICES

ug575_c4_flg2577_040217

Figure 4-52: Package Dimensions for FLGA2577 (XCVU9P and XCVU13P)

FLGA2577 Flip-Chip, Fine-Pitch BGA (XCVU11P)

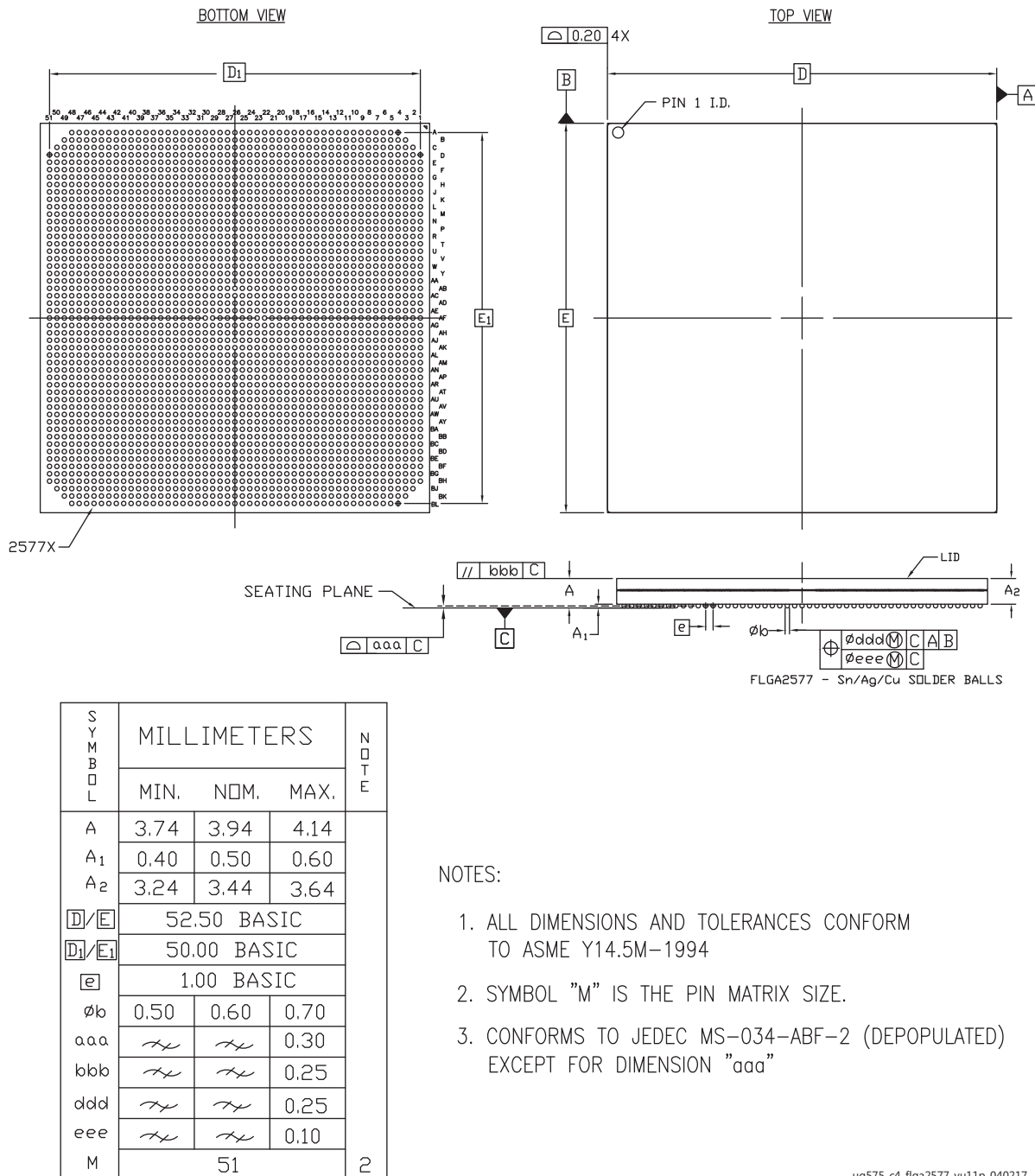

Figure 4-53: Package Dimensions for FLGA2577 (XCVU11P)

FSGA2577 Flip-Chip, Fine-Pitch BGA (XCVU13P, XCVU27P, and XCVU29P)

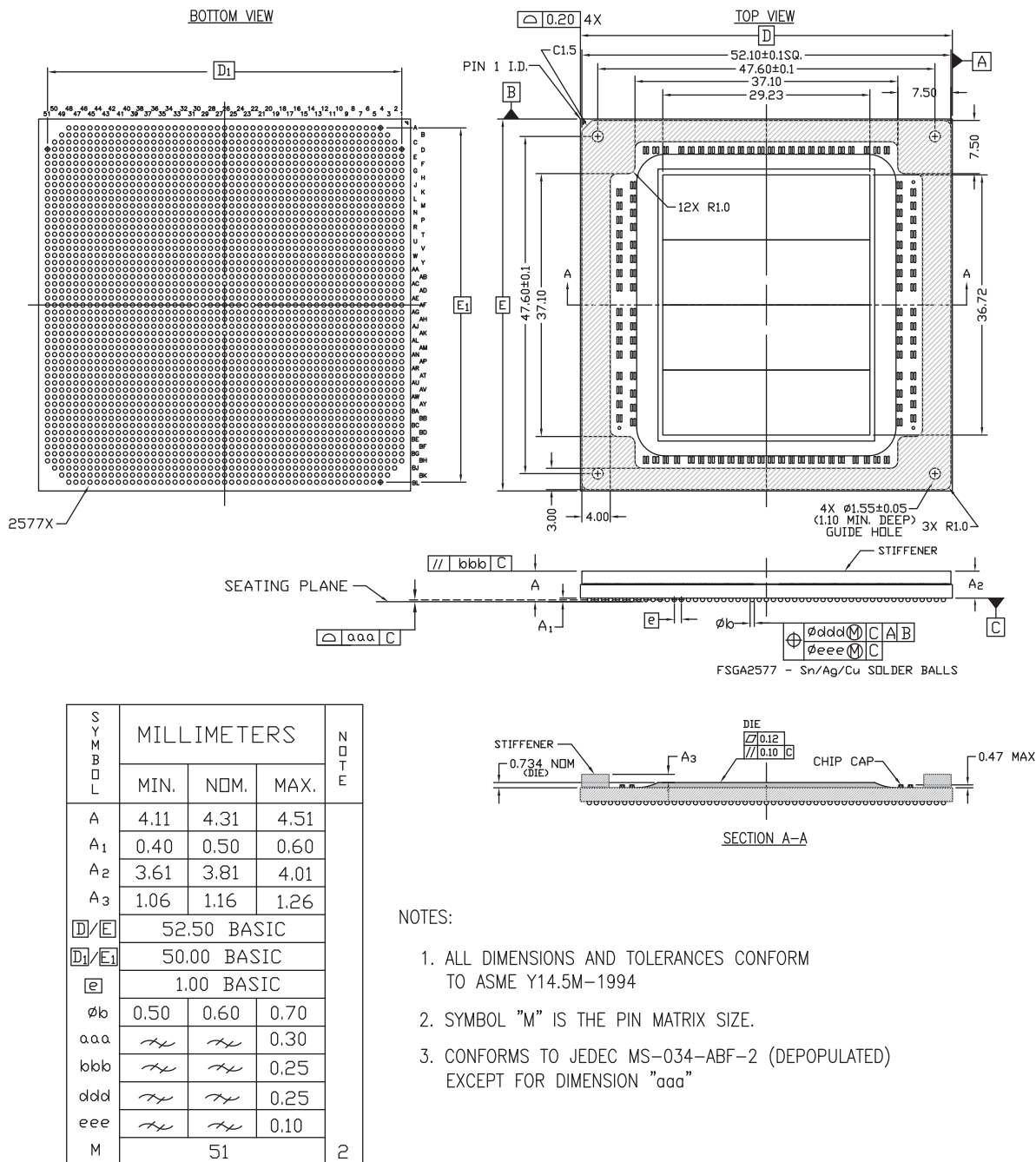
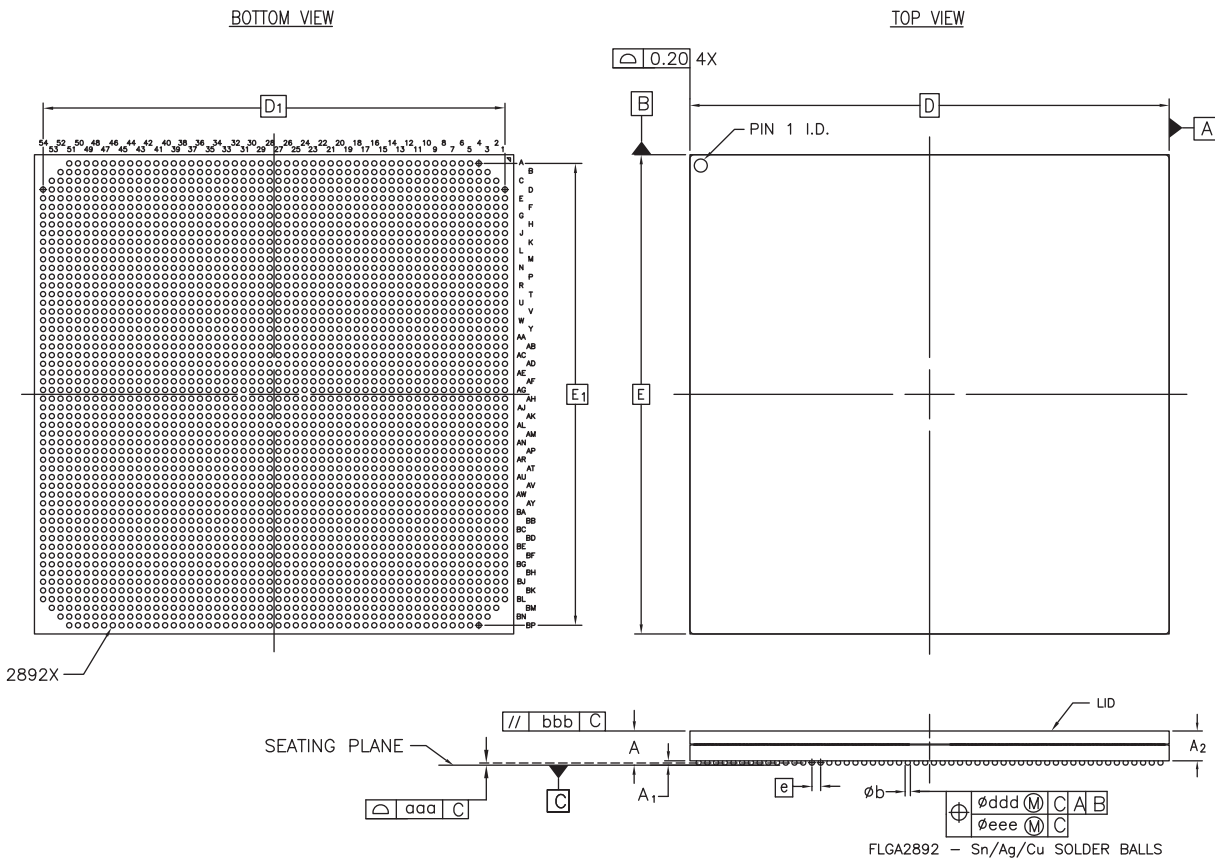

Figure 4-54: Package Dimensions for FSGA2577 (XCVU13P, XCVU27P, and XCVU29P)

FLGA2892 Flip-Chip, Fine-Pitch BGA (XCVU440)



SYMBOL	MILLIMETERS			NOTE
	MIN.	NOM.	MAX.	
A	3.73	3.93	4.13	2
A ₁	0.40	0.50	0.60	
A ₂	3.23	3.43	3.63	
D/E	55.00 BASIC			
D ₁ /E ₁	53.00 BASIC			
e	1.00 BASIC			
phi b	0.50	0.60	0.70	
aaa	<i>xxx</i>	<i>xxx</i>	0.30	
bbb	<i>xxx</i>	<i>xxx</i>	0.25	
ddd	<i>xxx</i>	<i>xxx</i>	0.25	
eee	<i>xxx</i>	<i>xxx</i>	0.10	
M	54			

NOTES:

1. ALL DIMENSIONS AND TOLERANCES CONFORM TO ASME Y14.5M-1994
2. SYMBOL "M" IS THE PIN MATRIX SIZE
3. CONFORMS TO JEDEC MS-034 ABG-1 (DEPOPULATED) EXCEPT FOR DIMENSION "aaa"

ug575_c4_14_100615

Figure 4-55: Package Dimensions for FLGA2892 (XCVU440)

FSVH2892 (XCVU35P) Flip-Chip, Fine-Pitch, Lidless with Stiffener Ring, BGA

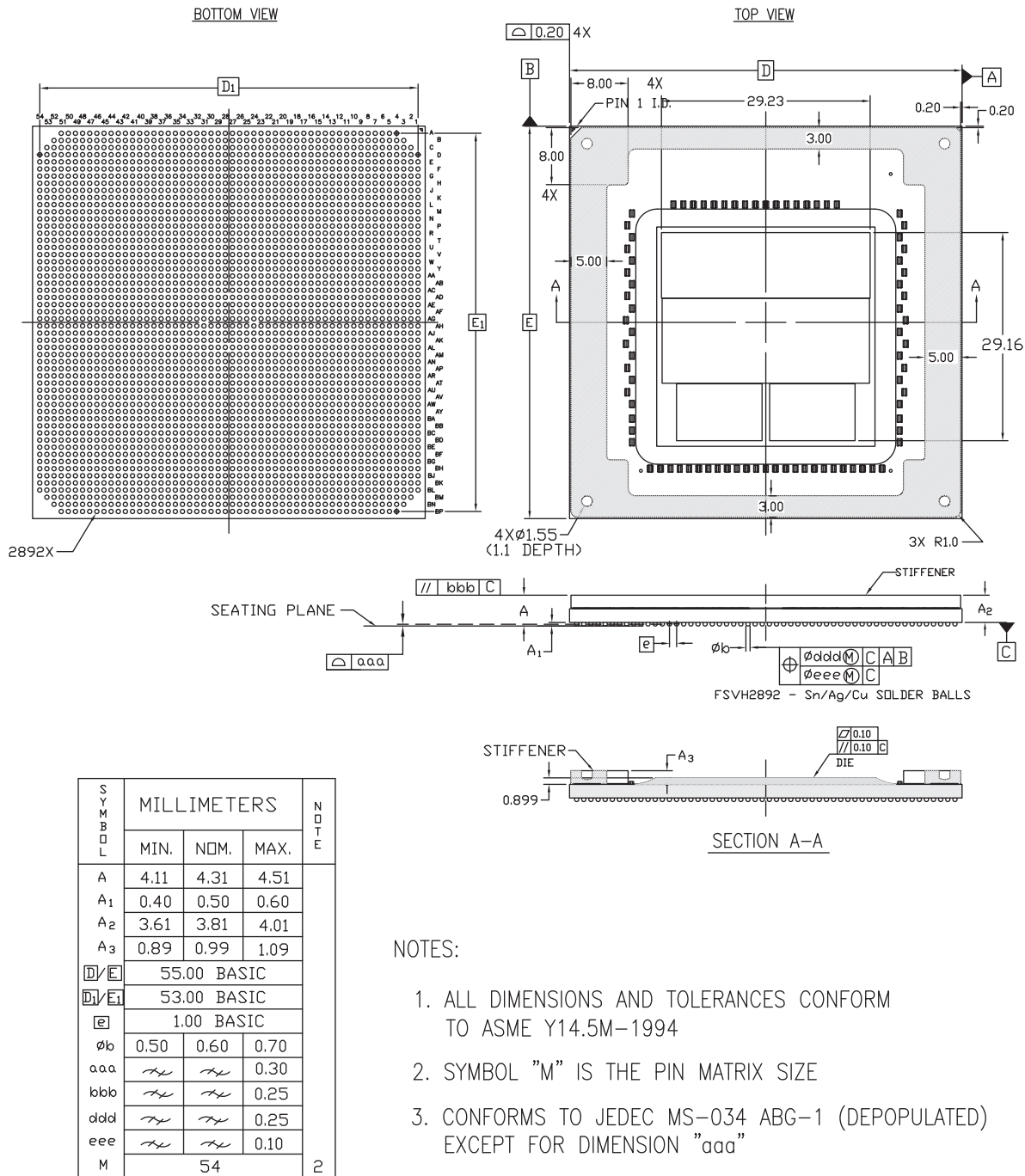

Figure 4-56: Package Dimensions for FSVH2892 (XCVU35P)

FSVH2892 (XCVU37P) Flip-Chip, Fine-Pitch, Lidless with Stiffener Ring, BGA

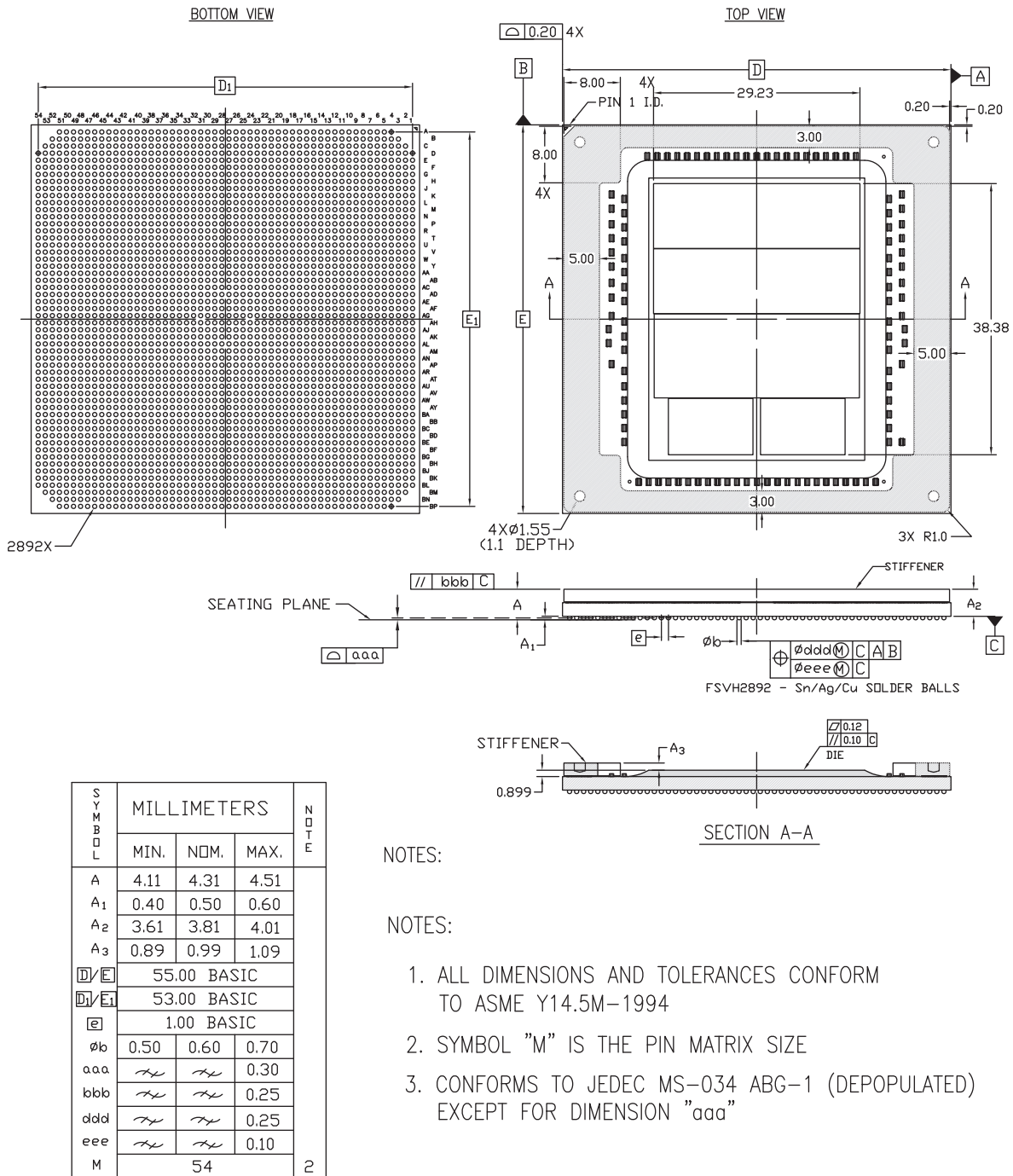

Figure 4-57: Package Dimensions for FSVH2892 (XCVU37P)

Package Marking

Introduction

The package top-markings for the UltraScale™ and UltraScale+™ devices are similar to the examples shown in [Figure 5-1](#), [Figure 5-2](#), [Figure 5-3](#), and [Figure 5-4](#). [Figure 5-1](#) and [Figure 5-2](#) show both old and changed top markings. In addition to the markings explained in [Table 5-1](#), refer to the *FAQ: Top Marking Change for 7 Series, UltraScale, and UltraScale+ Products* (XTP424) [[Ref 12](#)].

The package top-markings for the XQ Kintex UltraScale+ and XQ Virtex UltraScale+ devices are as shown in [Figure 5-5](#). On XQ products only the Xilinx logo and the 2D bar code are marked.

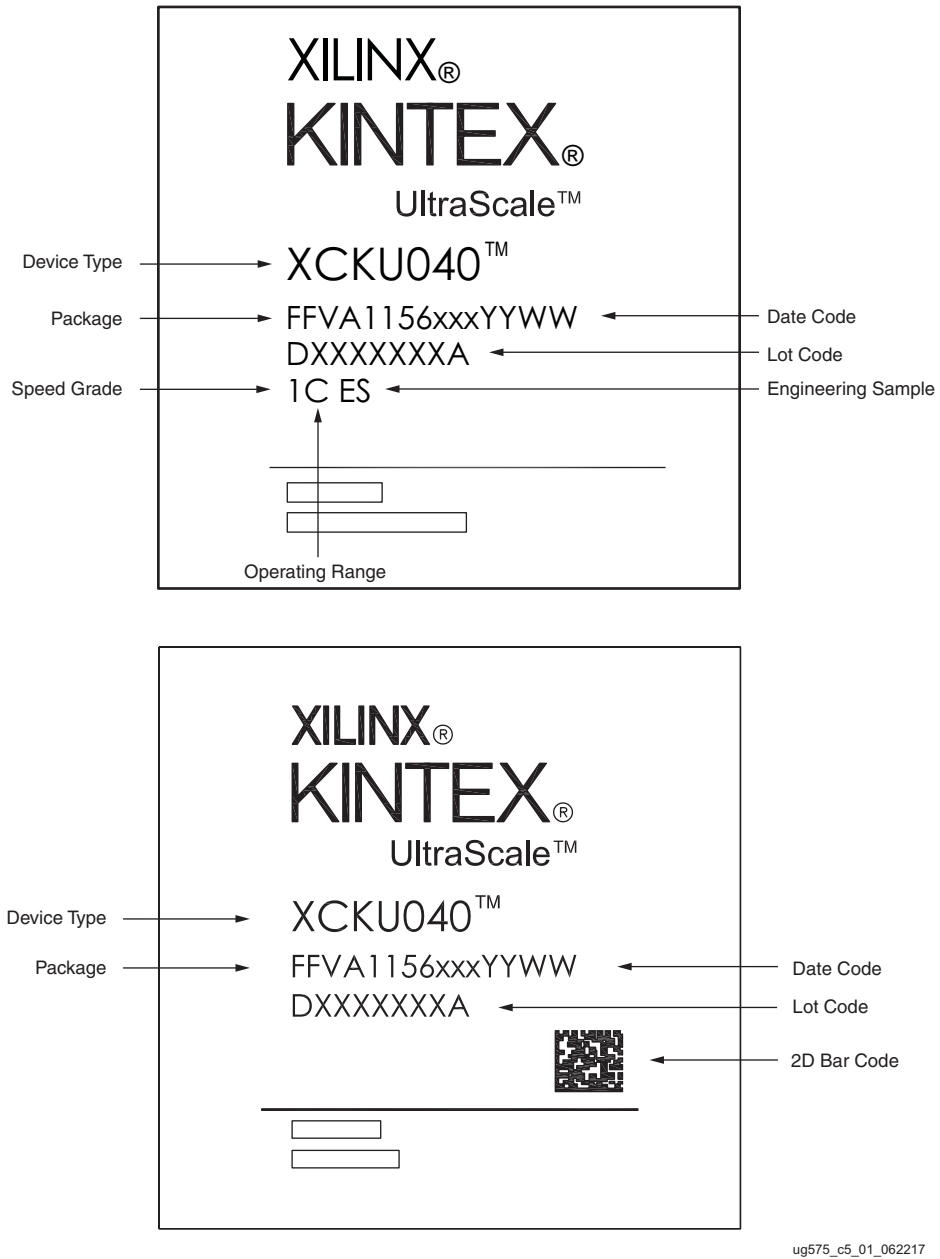

ug575_c5_01_062217

Figure 5-1: Kintex UltraScale Device Package Marking

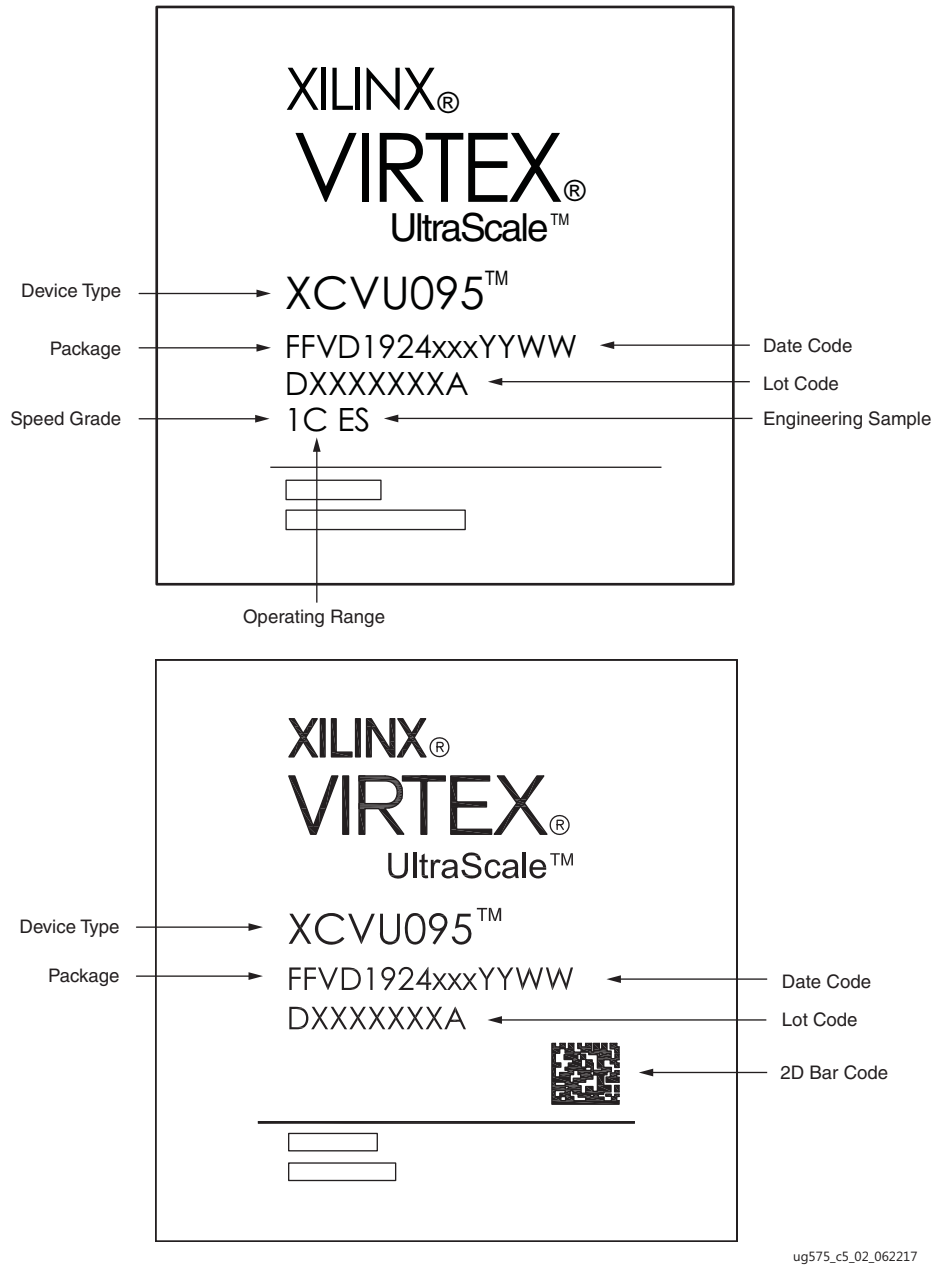

Figure 5-2: Virtex UltraScale Device Package Marking

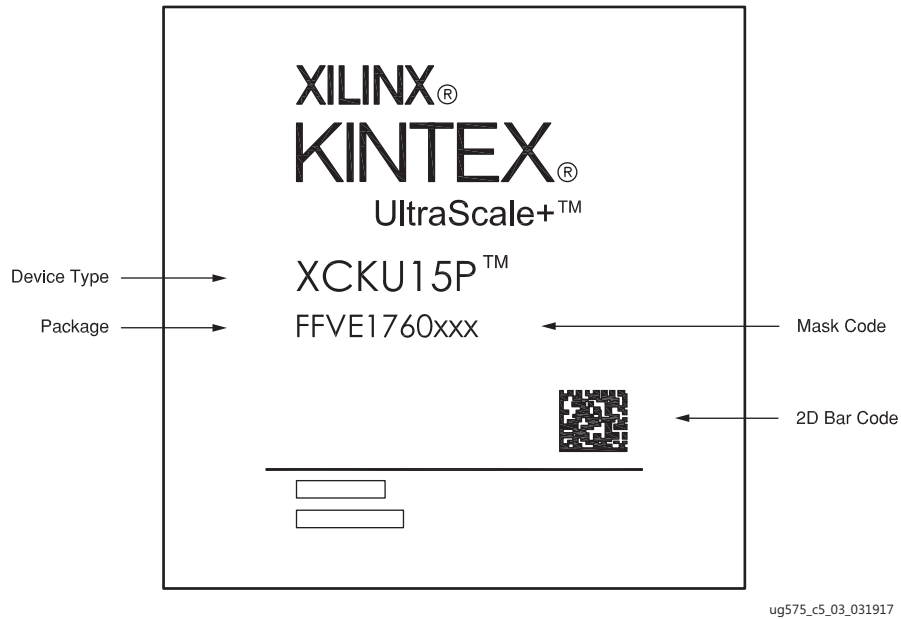

Figure 5-3: Kintex UltraScale+ Device Package Marking

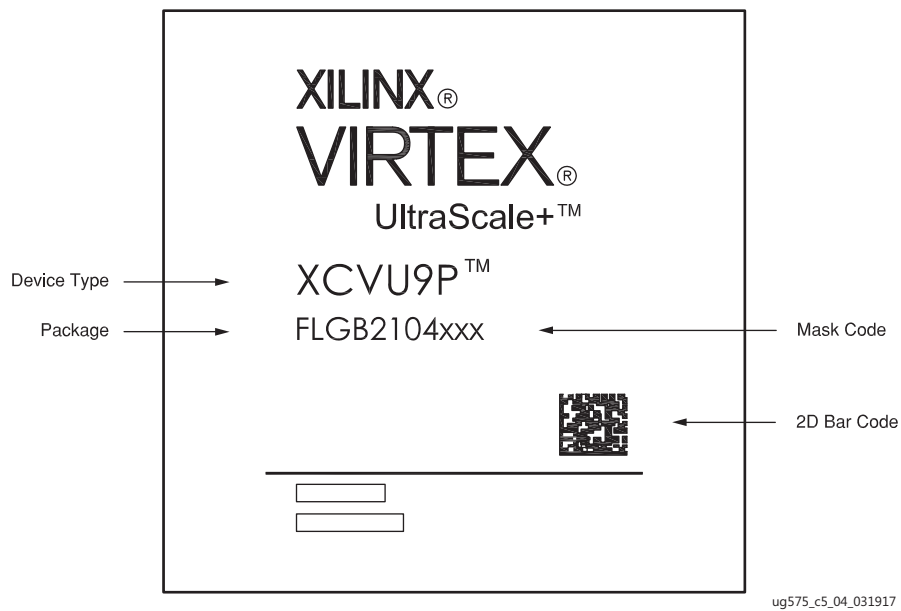

Figure 5-4: Virtex UltraScale+ Device Package Marking

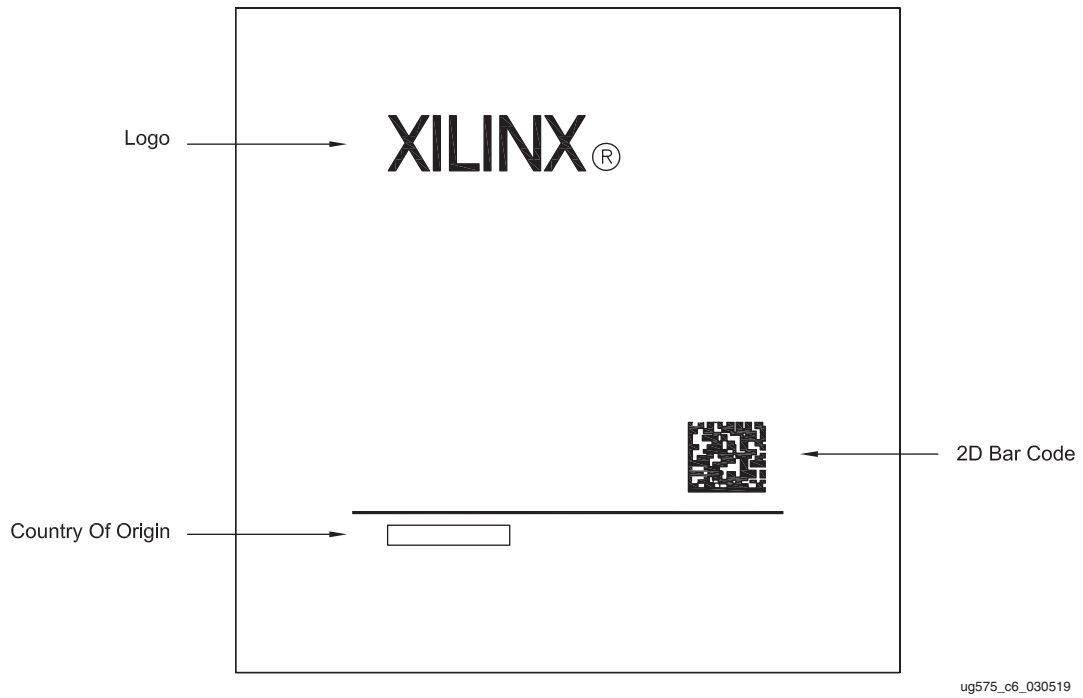

Figure 5-5: XQ Kintex UltraScale+ and XQ Virtex UltraScale+ Device Package Marking

Table 5-1: XC Device Marking Definition—Example

Item	Definition						
Xilinx Logo	Xilinx logo, Xilinx name with trademark, and trademark-registered status.						
Family Brand Logo	Device family name with trademark and trademark-registered status. This line is optional and could appear blank.						
1st Line	Device name.						
2nd Line	<ul style="list-style-type: none"> Package code: FF <ul style="list-style-type: none"> 1st digit: F for flip-chip BGA, S for flip-chip BGA with 0.8 mm ball pitch. 2nd digit: F for lidded, L for lidded SSI, B for bare-die, H for overhang SSI, S for lidless SSI stiffener, and I for overhang lidless SSI stiffener. 3rd digit: Pb-free code: V for RoHS 6/6, G for RoHS 6/6 with exemption 15, or for packages with eutectic BGA balls (R or Q). <p>All commercial (XC) UltraScale Architecture devices have Pb-free RoHS compliant packaging. For more details on Xilinx Pb-free and RoHS compliant products, see: www.xilinx.com/pbfree.</p> 4th digit: This is the pin out (net list) identifier. 5th–8th digits: These are the physical pin count identifiers: A1156 and D1924 are shown in the Figure 5-1 and Figure 5-2 example marking drawings. Example: A package code of FFVA1517 and FFVC1517 means they have a different pinout (net list) but the same physical ball count and physical dimensions. Three letter circuit design revision, the location code for the wafer fab, and the geometry code (xxx). Designated as the mask code in some figures. When marked, the date code: YYWW (two digit year and work week). This code is not marked on some devices. Refer to the bar code for more information. 						
3rd Line	<p>When marked, this line describes ten alphanumeric characters for assembly location, 7-digit lot number, and step information. The last digit is usually an A or an M if a stepping version does not exist.</p> <p>This line is not marked on some devices. Refer to the bar code for more information.</p>						
4th Line	<p>When marked, this line describes the device speed grade (1) and temperature operating range (C). When not marked on the package, the product is considered to operate at the extended (E) temperature range.</p> <p>If a bar code is present on the device, the 4th line might be blank or unmarked. In this case, refer to the bar code for speed grade and temperature range information. For more information on the ordering codes, see the <i>UltraScale Architecture and Product Overview</i> (DS890) [Ref 1].</p> <p>Other variations for the 4th line:</p> <table border="1"> <tbody> <tr> <td>L1I</td> <td>The L1I indicates a -1LI device. The -1LI speed grade offers reduced maximum power consumption. For more information, see the specific device's data sheet [Ref 3].</td> </tr> <tr> <td>1C xxxx</td> <td>The xxxx indicates a 4-digit SCD device option. An SCD is a special ordering code that is not always marked in the device top mark.</td> </tr> <tr> <td>1C ES 2E ES L1I ES</td> <td>The addition of an ES after the operating temperature range code indicates an engineering sample.</td> </tr> </tbody> </table>	L1I	The L1I indicates a -1LI device. The -1LI speed grade offers reduced maximum power consumption. For more information, see the specific device's data sheet [Ref 3] .	1C xxxx	The xxxx indicates a 4-digit SCD device option. An SCD is a special ordering code that is not always marked in the device top mark.	1C ES 2E ES L1I ES	The addition of an ES after the operating temperature range code indicates an engineering sample.
L1I	The L1I indicates a -1LI device. The -1LI speed grade offers reduced maximum power consumption. For more information, see the specific device's data sheet [Ref 3] .						
1C xxxx	The xxxx indicates a 4-digit SCD device option. An SCD is a special ordering code that is not always marked in the device top mark.						
1C ES 2E ES L1I ES	The addition of an ES after the operating temperature range code indicates an engineering sample.						
Bar Code	A device-specific bar code is marked on each device. Refer to the <i>FAQ: Top Marking Change for 7 Series, UltraScale, and UltraScale+ Products</i> (XTP424) [Ref 12] .						

Packing and Shipping

Introduction

The UltraScale and UltraScale+ devices are packed in trays. Trays are used to pack most of Xilinx surface-mount devices since they provide excellent protection from mechanical damage. In addition, they are manufactured using anti-static material to provide limited protection against ESD damage and can withstand a bake temperature of 125°C.

Table 6-1: Standard Device Counts per Tray and Box

Package	Maximum Number of Devices Per Tray	Maximum Number of Units In One Internal Box
FBVA676, RBA676	40	200
FFVA676, FFVB676, RRFB676	40	200
SFVA784, SFVB784, SFRB7784	60	300
FBVA900	27	135
FFVD900, FFVE900	27	135
FFVA1156, RFA1156, FFRA1156	24	120
FFVA1517, FFVC1517, FFVD1517, FFVE1517, FFRC1517, FFRE1517	21	105
FLVA1517, FLVD1517, RLD1517	21	63
FFVA1760, FFVB1760, FFVE1760	12	60
FLVB1760	12	36
FLVD1924, FLVF1924, RLF1924	12	36
FLGF1924	12	36
FSVH1924	12	36
FFVA2104, FLVA2104, FLGA2104, FLRA2104 FFVB2104, FLVB2104, FLGB2104, FLRB2104 FFVC2104, FLVC2104, FLGC2104, FLRC2104	12	36
FHGA2104, FHGB2104, FHGC2104 FIGD2104	10	30
FSGD2104	12	36
FSVH2104	12	36

Table 6-1: Standard Device Counts per Tray and Box (Cont'd)

Package	Maximum Number of Devices Per Tray	Maximum Number of Units In One Internal Box
FLGB2377	10	30
FLGA2577	10	30
FSGA2577	10	30
FLGA2892	10	30
FSVH2892	10	30



IMPORTANT: All packages are available with eutectic BGA balls. To order these packages, the device type starts with an XQ vs. XC, and the third digit in the package name is Q (for example: FFQA1156).

Soldering Guidelines

Soldering Guidelines

To implement and control the production of surface-mount assemblies, the dynamics of the Pb-free solder reflow process and how each element of the process is related to the end result must be thoroughly understood.



RECOMMENDED: *Xilinx recommends that customers qualify their custom PCB assembly processes using package samples.*

The primary phases of the Pb-free reflow process are:

- Melting the particles in the solder paste
- Wetting the surfaces to be joined
- Solidifying the solder into a strong metallurgical bond

The peak reflow temperature of a plastic surface-mount component (PSMC) body should not be more than 250°C maximum (260°C for dry rework only) for Pb-free packages (220°C for eutectic packages), and is package size dependent. For multiple BGAs in a single board and because of surrounding component differences, Xilinx recommends checking all BGA sites for varying temperatures.

The infrared reflow (IR) process is strongly dependent on equipment and loading. Components might overheat due to lack of thermal constraints. Unbalanced loading can lead to significant temperature variation on the board. These guidelines are intended to assist users in avoiding damage to the components; the actual profile should be determined by those using these guidelines. For complete information on package moisture / reflow classification and package reflow conditions, refer to the Joint IPC/JEDEC Standard J-STD-020C.

Sn/Pb Reflow Soldering

Figure 7-1 shows typical conditions for solder reflow processing of Sn/Pb soldering using IR/convection. Both IR and convection furnaces are used for BGA assembly. The moisture sensitivity of PSMCs must be verified prior to surface-mount flow.

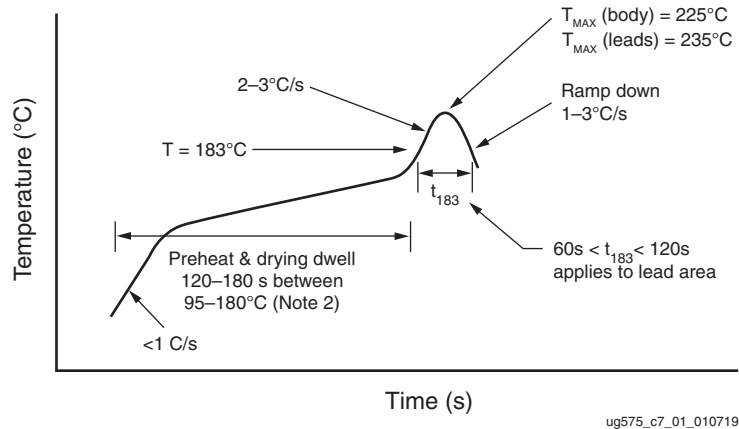

Figure 7-1: Typical Conditions for IR Reflow Soldering of Sn/Pb Solder

Notes for Figure 7-1:

1. Maximum temperature range = $225\text{ }^\circ\text{C}$ (body). Minimum temperature range = $205\text{ }^\circ\text{C}$ (leads/balls).
2. Preheat dwell $95\text{--}180\text{ }^\circ\text{C}$ for $120\text{--}180$ seconds.
3. IR reflow must be performed on dry packages.

Pb-Free Reflow Soldering

Xilinx uses SnAgCu solder balls for BGA packages. In addition, suitable material are qualified for the higher reflow temperatures (250°C maximum, 260°C for dry rework only) required by Pb-free soldering processes.

Xilinx does not recommend soldering SnAgCu BGA packages with SnPb solder paste using a Sn/Pb soldering process. Traditional Sn/Pb soldering processes have a peak reflow temperature of 220°C. At this temperature range, the SnAgCu BGA solder balls do not properly melt and wet to the soldering surfaces. As a result, reliability and assembly yields can be compromised.

The optimal profile must take into account the solder paste/flux used, the size of the board, the density of the components on the board, and the mix between large components and smaller, lighter components. Profiles should be established for all new board designs using thermocouples at multiple locations on the component. In addition, if there is a mixture of devices on the board, then the profile should be checked at various locations on the board. Ensure that the minimum reflow temperature is reached to reflow the larger components and at the same time, the temperature does not exceed the threshold temperature that might damage the smaller, heat sensitive components.

[Table 7-1](#) and [Figure 7-2](#) provide guidelines for profiling Pb-free solder reflow. In general, a gradual, linear ramp into a spike has been shown by various sources to be the optimal reflow profile for Pb-free solders ([Figure 7-2](#)). This profile has been shown to yield better wetting and less thermal shock than conventional ramp-soak-spike profile for the Sn/Pb system. SnAgCu alloy reaches full liquidus temperature at 235°C. When profiling, identify the possible locations of the coldest solder joints and ensure that those solder joints reach a minimum peak temperature of 235°C for at least 10 seconds. Reflowing at high peak temperatures of 260°C and above can damage the heat sensitive components and cause the board to warp. Users should reference the latest IPC/JEDEC J-STD-020 standard for the allowable peak temperature on the component body. The allowable peak temperature on the component body is dependent on the size of the component. Refer to [Table 7-2](#) for peak package reflow body temperature information. In any case, use a reflow profile with the lowest peak temperature possible.

Table 7-1: Pb-Free Reflow Soldering Guidelines

Profile Feature	Convection, IR/Convection
Ramp-up rate	2°C/s maximum 1°C/s maximum for lidless packages with stiffener ring
Preheat Temperature 150°–200°C	60–120 seconds
Temperature maintained above 217°C	60–150 seconds (60–90 seconds typical)
Time within 5°C of actual peak temperature	30 seconds maximum
Peak Temperature (lead/ball)	230°C—245°C typical (depends on solder paste, board size, component mixture)
Maximum Peak Temperature (body)	240°C—250°C, package body size dependent (see specific device data sheets [Ref 3])
Ramp-down rate	2°C/s maximum
Time 25°C to Peak Temperature	3.5 minutes minimum, 5.0 minutes typical, 8 minutes maximum

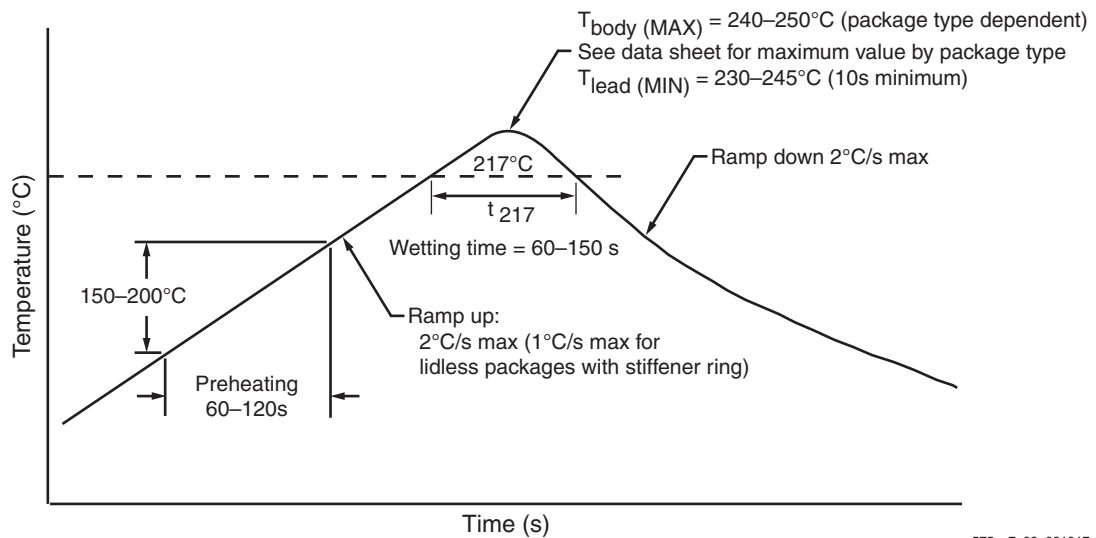

Figure 7-2: Typical Conditions for Pb-Free Reflow Soldering

Table 7-2: Peak Package Reflow Body Temperature for Xilinx Packages (Based on J-STD-020 Standard)

Package	Product Category	Peak Package Reflow Body Temperature ⁽¹⁾	JEDEC Moisture Sensitivity Level (MSL)
FBVA676 FFVA676, FFVB676 SFVA784, SFVB784	XC	Mass reflow: 250°C Dry rework: 260°C	4
FBVA900 FFVD900, FFVE900 FFVA1156 FFVA1517, FLVA1517, FFVC1517, FFVD1517, FLVD1517, FFVE1517 FFVA1760, FFVB1760, FLVB1760, FFVE1760 FLVD1924, FLVF1924, FLGF1924 FFVA2104, FLVA2104, FLGA2104, FHGA2104 FFVB2104, FLVB2104, FLGB2104, FHGB2104 FFVC2104, FLVC2104, FLGC2104, FHGC2104 FLGB2377 FLGA2577 FLGA2892	All	Mass reflow: 245°C Dry rework: 260°C	4
FSVH1924 FSGD2104, FIGD2104, FSVH2104 FSGA2577 FSVH2892	All	Mass reflow: 240°C Dry rework: 260°C	4
RBA676, RFA1156, RLD1517, RLF1924 FFRB676, SFRB784 FFRA1156, FFRC1517, FFRE1517 FLRA2104, FLRB2104, FLRC2104	XQ ⁽²⁾	Mass reflow: 225°C Dry rework: 235°C	4

Notes:

1. See the specific *UltraScale and UltraScale+ device data sheets* [Ref 3] for the most up-to-date specifications.
2. For devices with the Pb-free signifier in the package name (labeled as Q vs. V) use the temperatures and MSL listed for the XQ product category.

For sophisticated boards with a substantial mix of large and small components, it is critical to minimize the ΔT across the board ($<10^{\circ}\text{C}$) to minimize board warpage and thus, attain higher assembly yields. Minimizing the ΔT is accomplished by using a slower rate in the warm-up and preheating stages. Xilinx recommends a heating rate of less than 1°C/s during the preheating and soaking stages, in combination with a heating rate of not more than 3°C/s throughout the rest of the profile.

It is also important to minimize the temperature gradient on the component, between top surface and bottom side, especially during the cooling down phase. The key is to optimize cooling while maintaining a minimal temperature differential between the top surface of the package and the solder joint area. The temperature differential between the top surface of the component and the solder balls should be maintained at less than 7°C during the critical region of the cooling phase of the reflow process. This critical region is in the part of the cooling phase where the balls are not completely solidified to the board yet, usually between the 200°C–217°C range. To efficiently cool the parts, divide the cooling section into multiple zones, with each zone operating at different temperatures.

Post Reflow/Cleaning/Washing

Many PCB assembly subcontractors use a no-clean process in which no post-assembly washing is required. Although a no-clean process is recommended, if cleaning is required, Xilinx recommends a water-soluble paste and a washer using a deionized-water. Baking after the water wash is recommended to prevent fluid accumulation.

Cleaning solutions or solvents are not recommended because some solutions contain chemicals that can compromise the lid adhesive, thermal compound, or components inside the package.

Conformal Coating

Xilinx does not have information regarding the reliability of flip-chip BGA packages on a board after exposure to any specific conformal coating process. Therefore, any process using conformal coating should be qualified for the specific use case to cover the materials and process steps.

Ruggedized XQ packages are designed to support conformal coating, with vented lids that ensure proper cleaning can occur after the etching process and prior to conformal coating.



RECOMMENDED: *When a conformal coating is required, Parylene-based material should be used to avoid potential risk of weakening the lid adhesive used in Xilinx packages.*

Recommended PCB Design Rules for BGA Packages

BGA Packages

Xilinx provides the diameter of a land pad on the package side. This information is required prior to the start of the board layout so the board pads can be designed to match the component-side land geometry. The typical values of these land pads are described in [Figure 8-1](#) and summarized in [Table 8-1](#) for 1.0 mm pitch packages. For Xilinx BGA packages, non-solder mask defined (NSMD) pads on the board are suggested to allow a clearance between the land metal (diameter L) and the solder mask opening (diameter M) as shown in [Figure 8-1](#). An example of an NSMD PCB pad solder joint is shown in [Figure 8-2](#). It is recommended to have the board land pad diameter with a 1:1 ratio to the package solder mask defined (SMD) pad for improved board level reliability. The space between the NSMD pad and the solder mask as well as the actual signal trace widths depend on the capability of the PCB vendor. The cost of the PCB is higher when the line width and spaces are smaller.

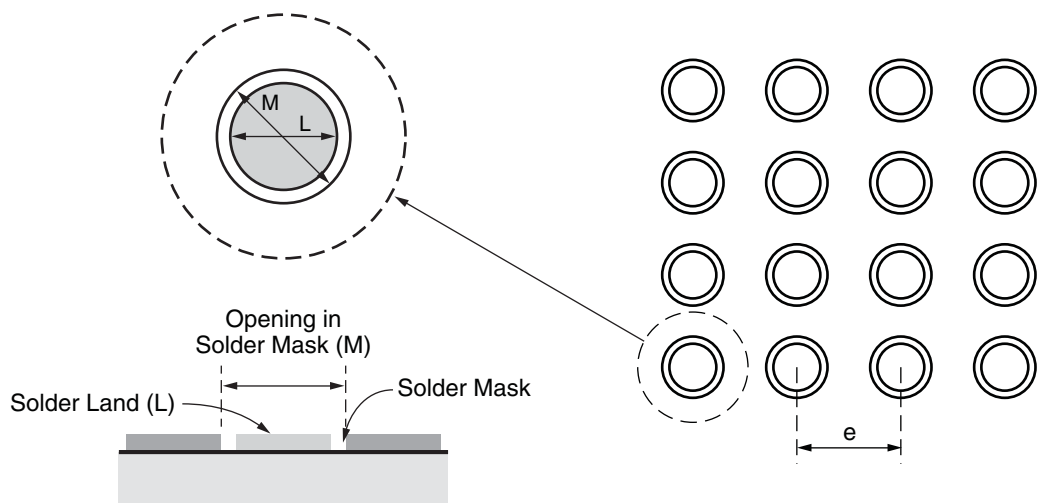

UG575_c8_01_102213

Figure 8-1: Suggested Board Layout of Soldered Pads for BGA Packages

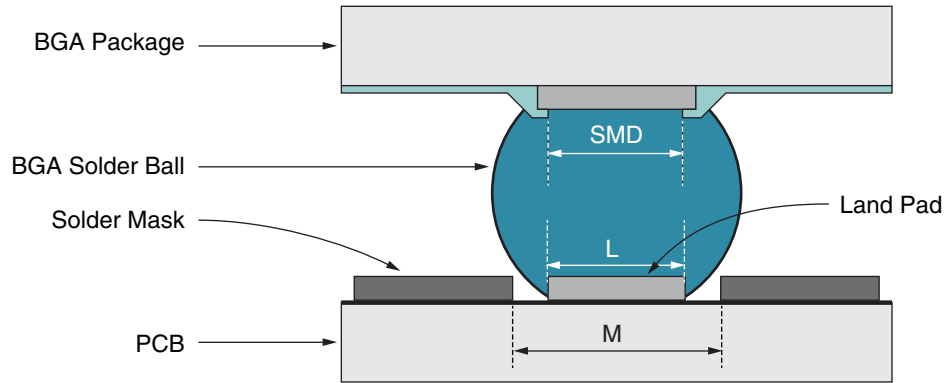

UG358_aA_02_110513

Figure 8-2: Example of an NSMD PCB Pad Solder Joint

Table 8-1: BGA Package Design Rules

Flip-Chip BGA Packages	1.0 mm Pitch	0.8 mm Pitch
Design Rule	Dimensions in mm (mils)	
Package land pad opening (SMD)	0.53 mm (20.9 mils)	0.40 mm (15.7 mils)
Maximum PCB solder land (L) diameter	0.53 mm (20.9 mils)	0.40 mm (15.7 mils)
Opening in PCB solder mask (M) diameter	0.63 mm (24.8 mils)	0.50 mm (19.7 mils)
Solder ball land pitch (e)	1.00 mm (39.4 mils)	0.80 mm (31.5 mils)

Notes:

1. Controlling dimension in mm.

Thermal Specifications

Introduction

UltraScale and UltraScale+ devices are offered exclusively in thermally efficient flip-chip BGA packages. These flip-chip packages range in pin-count from the smaller 23 x 23 mm SFVA784 to the 55 x 55 mm FLGA2892. This suite of packages is used to address the various power requirements of the UltraScale and UltraScale+ devices. UltraScale devices are implemented in the 20 nm process technology. UltraScale+ devices are implemented in the 16 nm process technology.

Unlike features in an ASIC or a microprocessor, the combination of FPGA features used in a user application is not known to the component supplier. Therefore, it remains a challenge for Xilinx to predict the power requirements of a given FPGA when it leaves the factory. Accurate estimates are obtained when the board design takes shape. For this purpose, Xilinx offers and supports a suite of integrated device power analysis tools to help users quickly and accurately estimate their design power requirements. UltraScale and UltraScale+ devices are supported similarly to previous FPGA products. The uncertainty of design power requirements makes it difficult to apply canned thermal solutions to fit all users. Therefore, Xilinx devices do not come with preset thermal solutions. Your design operating conditions dictate the appropriate solution.

Thermal Resistance Data

Table 9-1 shows the thermal resistance data for UltraScale and UltraScale+ devices (grouped in the packages offered). The data includes junction-to-ambient in still air, junction-to-case, and junction-to-board data based on standard JEDEC four-layer measurements.



IMPORTANT: The data in Table 9-1 is for device/package comparison purposes only. Attempts to recreate this data are only valid using the transient 2-phase measurement techniques outlined in JESD51-14.



TIP: The thermal data query for all available devices by package is available on the Xilinx website: www.xilinx.com/cgi-bin/thermal/thermal.pl.



IMPORTANT: All packages are available with eutectic BGA balls. To order these packages, the device type starts with an XQ vs. XC, and the third digit in the package name is Q (for example: FFQA1156). Refer to the XC version of these packages for their thermal resistance data and thermal models.

Table 9-1: Thermal Resistance Data

Package	Package Body Size	Devices	θ_{JB} (°C/W) ⁽²⁾	θ_{JC} (°C/W) ⁽²⁾	θ_{JA} (°C/W) ⁽²⁾	θ_{JA} -Effective (°C/W) ⁽¹⁾⁽²⁾		
						@250 LFM	@500 LFM	@750 LFM
Kintex UltraScale Devices								
FBVA676	27 x 27	XCKU035	2.4	0.03	11.7	7.9	6.6	6.2
		XCKU040	2.4	0.03	11.7	7.9	6.6	6.2
RBA676	27 x 27	XQKU040	3.2	0.26	12.4	8.3	6.9	6.5
SFVA784	23 x 23	XCKU035	2.0	0.21	13.1	9.4	7.9	7.3
		XCKU040	2.0	0.21	13.1	9.4	7.9	7.3
FBVA900	31 x 31	XCKU035	2.5	0.03	10.5	6.8	5.7	5.3
		XCKU040	2.5	0.03	10.5	6.8	5.7	5.3
FFVA1156	35 x 35	XCKU025	2.5	0.21	9.5	5.9	5.0	4.6
		XCKU035	2.5	0.21	9.5	5.9	5.0	4.6
		XCKU040	2.5	0.21	9.5	5.9	5.0	4.6
		XCKU060	1.9	0.15	8.9	5.7	4.7	4.5
		XCKU095	1.7	0.10	8.8	5.6	4.7	4.4
RFA1156	35 x 35	XQKU040	3.0	0.26	9.9	6.1	5.1	4.8
		XQKU060	2.6	0.18	9.6	6.0	5.0	4.7
		XQKU095	2.3	0.12	9.3	5.9	4.9	4.6
FFVA1517	40 x 40	XCKU060	1.9	0.15	7.9	4.8	4.1	3.8
FLVA1517	40 x 40	XCKU085	1.7	0.10	7.8	4.8	4.0	3.8
		XCKU115	1.7	0.10	7.8	4.8	4.0	3.8
FFVC1517	40 x 40	XCKU095	1.7	0.10	7.8	4.8	4.0	3.8
FLVD1517	40 x 40	XCKU115	1.7	0.10	7.8	4.8	4.0	3.8
RLD1517	40 x 40	XQKU115	2.1	0.10	7.4	4.3	3.6	3.9
FFVB1760	42.5 x 42.5	XCKU095	1.7	0.10	7.4	4.5	3.7	3.5
FLVB1760	42.5 x 42.5	XCKU085	1.7	0.10	7.4	4.4	3.7	3.5
		XCKU115	1.7	0.10	7.4	4.4	3.7	3.5
FLVD1924	45 x 45	XCKU115	1.7	0.10	7.0	4.2	3.5	3.3
FLVF1924	45 x 45	XCKU085	1.7	0.10	7.0	4.2	3.5	3.3
		XCKU115	1.7	0.10	7.0	4.2	3.5	3.3
RLF1924	45 x 45	XQKU115	2.1	0.10	7.4	4.3	3.6	3.4
FLVA2104	47.5 x 47.5	XCKU115	1.7	0.10	6.7	3.9	3.3	3.1

Table 9-1: Thermal Resistance Data (Cont'd)

Package	Package Body Size	Devices	θ_{JB} (°C/W) ⁽²⁾	θ_{JC} (°C/W) ⁽²⁾	θ_{JA} (°C/W) ⁽²⁾	θ_{JA} -Effective (°C/W) ⁽¹⁾⁽²⁾		
						@250 LFM	@500 LFM	@750 LFM
FFVB2104	47.5 x 47.5	XCKU095	1.7	0.10	6.7	3.9	3.3	3.1
FLVB2104	47.5 x 47.5	XCKU115	1.7	0.10	6.7	3.9	3.3	3.1
Virtex UltraScale Devices								
FFVC1517	40 x 40	XCVU065	1.7	0.18	7.8	4.8	4.0	3.8
		XCVU080	1.7	0.10	7.8	4.8	4.0	3.8
		XCVU095	1.7	0.10	7.8	4.8	4.0	3.8
FFVD1517	40 x 40	XCVU080	1.7	0.10	7.8	4.8	4.0	3.8
		XCVU095	1.7	0.10	7.8	4.8	4.0	3.8
FLVD1517	40 x 40	XCVU125	1.6	0.09	7.7	4.7	4.0	3.7
FFVB1760	42.5 x 42.5	XCVU080	1.7	0.10	7.4	4.5	3.7	3.5
		XCVU095	1.7	0.10	7.4	4.5	3.7	3.5
FLVB1760	42.5 x 42.5	XCVU125	1.7	0.09	7.4	4.4	3.7	3.5
FFVA2104	47.5 x 47.5	XCVU080	1.7	0.10	6.7	3.9	3.3	3.1
		XCVU095	1.7	0.10	6.7	3.9	3.3	3.1
FLVA2104	47.5 x 47.5	XCVU125	1.8	0.09	6.8	3.9	3.3	3.1
FFVB2104	47.5 x 47.5	XCVU080	1.7	0.10	6.7	3.9	3.3	3.1
		XCVU095	1.7	0.10	6.7	3.9	3.3	3.1
FLVB2104	47.5 x 47.5	XCVU125	1.8	0.09	6.8	3.9	3.3	3.1
FLGB2104	47.5 x 47.5	XCVU160	1.5	0.06	6.5	3.8	3.2	3.0
		XCVU190	1.5	0.06	6.5	3.8	3.2	3.0
FFVC2104	47.5 x 47.5	XCVU095	1.7	0.10	6.7	3.9	3.3	3.1
FLVC2104	47.5 x 47.5	XCVU125	1.8	0.09	6.8	3.9	3.3	3.1
FLGC2104	47.5 x 47.5	XCVU160	1.5	0.06	6.5	3.8	3.2	3.0
		XCVU190	1.5	0.06	6.5	3.8	3.2	3.0
FLGB2377	50 x 50	XCVU440	1.4	0.05	6.2	3.6	3.0	2.8
FLGA2577	52.5 x 52.5	XCVU190	1.4	0.06	5.9	3.4	2.8	2.7
FLGA2892	55 x 55	XCVU440	1.5	0.04	5.7	3.2	2.7	2.5

Table 9-1: Thermal Resistance Data (Cont'd)

Package	Package Body Size	Devices	θ_{JB} (°C/W) ⁽²⁾	θ_{JC} (°C/W) ⁽²⁾	θ_{JA} (°C/W) ⁽²⁾	θ_{JA} -Effective (°C/W) ⁽¹⁾⁽²⁾		
						@250 LFM	@500 LFM	@750 LFM
Kintex UltraScale+ Devices								
FFVA676	27 x 27	XCKU3P	2.07	0.25	10.2	7.1	6.0	5.6
		XCKU5P	2.07	0.25	10.2	7.1	6.0	5.6
FFVB676	27 x 27	XCKU3P	2.07	0.25	10.2	7.1	6.0	5.6
		XCKU5P	2.07	0.25	10.2	7.1	6.0	5.6
FFRB676	27 x 27	XQKU5P	2.26	0.27	10.4	7.3	6.1	5.7
SFVB784	23 x 23	XCKU3P	2.06	0.25	11.9	8.7	7.3	6.9
		XCKU5P	2.06	0.25	11.9	8.7	7.3	6.9
SFRB784	23 x 23	XQKU5P						
FFVD900	31 x 31	XCKU3P	2.22	0.26	9.0	6.1	5.1	4.8
		XCKU5P	2.22	0.26	9.0	6.1	5.1	4.8
		XCKU11P	1.83	0.14	8.7	5.9	4.9	4.6
FFVE900	31 x 31	XCKU9P	2.33	0.25	9.2	6.1	5.1	4.9
		XCKU13P	2.25	0.18	9.1	6.1	5.1	4.8
FFVA1156	35 x 35	XCKU11P	1.97	0.14	7.8	5.1	4.2	4.0
		XCKU15P	1.69	0.10	7.6	5.0	4.1	3.9
FFRA1156	35 x 35	XQKU15P	1.92	0.11	7.7	5.1	4.2	4.0
FFVE1517	40 x 40	XCKU11P	1.96	0.14	6.8	4.3	3.6	3.4
		XCKU15P	1.76	0.10	6.6	4.2	3.5	3.4
FFRE1517	40 x 40	XQKU15P	1.90	0.11	6.8	4.3	3.5	3.4
FFVA1760	42.5 x 42.5	XCKU15P	1.77	0.10	6.3	3.9	3.2	3.1
FFVE1760	42.5 x 42.5	XCKU15P	1.77	0.10	6.3	3.9	3.2	3.1
Virtex UltraScale+ Devices								
FFVC1517	40 x 40	XCVU3P	1.82	0.14	6.7	4.2	3.5	3.4
FFRC1517	40 x 40	XQVU3P	1.95	0.14	6.8	4.3	3.6	3.4
FLGF1924	45 x 45	XCVU11P	1.48	0.07	5.7	3.5	2.9	2.8
FSVH1924	45 x 45	XCVU31P	2.10	0.04	6.2	3.8	3.1	3.0
FLVA2104	47.5 x 47.5	XCVU5P	1.69	0.09	5.5	3.3	2.8	2.7
		XCVU7P	1.69	0.09	5.5	3.3	2.8	2.7
FLRA2104	47.5 x 47.5	XQVU7P						

Table 9-1: Thermal Resistance Data (Cont'd)

Package	Package Body Size	Devices	θ_{JB} (°C/W) ⁽²⁾	θ_{JC} (°C/W) ⁽²⁾	θ_{JA} (°C/W) ⁽²⁾	$\theta_{JA-Effective}$ (°C/W) ⁽¹⁾⁽²⁾		
						@250 LFM	@500 LFM	@750 LFM
FLGA2104	47.5 x 47.5	XCVU9P	1.45	0.06	5.4	3.3	2.7	2.6
FHGA2104	52.5 x 52.5	XCVU13P	1.45	0.05	5.4	3.3	2.7	2.6
FLVB2104	47.5 x 47.5	XCVU5P	1.69	0.09	5.5	3.3	2.8	2.7
		XCVU7P	1.69	0.09	5.5	3.3	2.8	2.7
FLRB2104	47.5 x 47.5	XQVU7P						
FLGB2104	47.5 x 47.5	XCVU9P	1.45	0.06	5.4	3.3	2.7	2.6
		XCVU11P	1.53	0.07	5.5	3.3	2.7	2.6
FHGB2104	52.5 x 52.5	XCVU13P	1.45	0.05	5.4	3.3	2.7	2.6
FLVC2104	47.5 x 47.5	XCVU5P	1.69	0.09	5.5	3.3	2.8	2.7
		XCVU7P	1.69	0.09	5.5	3.3	2.8	2.7
FLGC2104	47.5 x 47.5	XCVU9P	1.45	0.06	5.4	3.3	2.7	2.6
		XCVU11P	1.53	0.07	5.5	3.3	2.7	2.6
FLRC2104	47.5 x 47.5	XQVU11P						
FHGC2104	52.5 x 52.5	XCVU13P	1.45	0.05	5.4	3.3	2.7	2.6
FIGD2104	52.5 x 52.5	XCVU13P	1.54	0.01	7.6	4.4	3.6	3.3
		XCVU27P	1.54	0.01	7.6	4.4	3.6	3.3
		XCVU29P	1.54	0.01	7.6	4.4	3.6	3.3
FSGD2104	47.5 x 47.5	XCVU9P	1.66	0.01	7.8	4.8	3.9	3.5
		XCVU11P	1.63	0.01	7.9	4.9	4.0	3.7
FSVH2104	47.5 x 47.5	XCVU33P	2.10	0.03	5.9	3.5	2.9	2.8
		XCVU35P	1.78	0.02	5.6	3.4	2.8	2.7
FLGA2577	52.5 x 52.5	XCVU9P	1.61	0.06	5.0	2.9	2.4	2.3
		XCVU11P	1.70	0.07	5.0	2.9	2.5	2.4
		XCVU13P	1.63	0.05	5.0	2.9	2.4	2.4
FSGA2577	52.5 x 52.5	XCVU13P	1.61	0.01	7.6	4.4	3.6	3.3
FSGA2577	52.5 x 52.5	XCVU27P	1.61	0.01	7.6	4.4	3.6	3.3
		XCVU29P	1.61	0.01	7.6	4.4	3.6	3.3
FSVH2892	55 x 55	XCVU35P	1.91	0.02	4.9	2.9	2.4	2.3
		XCVU37P	1.72	0.01	4.8	2.8	2.2	2.2

Notes:

1. All $\theta_{JA-Effective}$ values assume no heat sink and include thermal dissipation through a standard JEDEC four-layer board. The Xilinx power estimation tools (Vivado® Power Analysis and Xilinx Power Estimator), which require detailed board dimensions and layer counts, are useful for deriving more precise $\theta_{JA-Effective}$ values.
2. This data is for device/package comparison purposes only. Attempts to recreate this data are only valid using the transient 2-phase measurement techniques outlined in JESD51-14.

Support for Thermal Models

Table 9-1 provides the traditional thermal resistance data for UltraScale and UltraScale+ devices. These resistances are measured using a prescribed JEDEC standard that might not necessarily reflect your actual board conditions and environment. The quoted θ_{JA} and θ_{JC} numbers are environmentally dependent, and JEDEC has traditionally recommended that these be used with that awareness. For more accurate junction temperature prediction, these might not be enough, and a system-level thermal simulation might be required.

Though Xilinx continues to support these figure of merit data, for UltraScale and UltraScale+ devices, boundary conditions independent thermal resistor network (Delphi) models are offered for all UltraScale and UltraScale+ devices. These compact models seek to capture the thermal behavior of the packages more accurately at predetermined critical points (junction, case, top, leads, and so on) with the reduced set of nodes as illustrated in Figure 9-1.

Unlike a full 3D model, these are computationally efficient and work well in an integrated system simulation environment. Delphi models are available for download on the Xilinx website (under the [Device Model](#) tab).

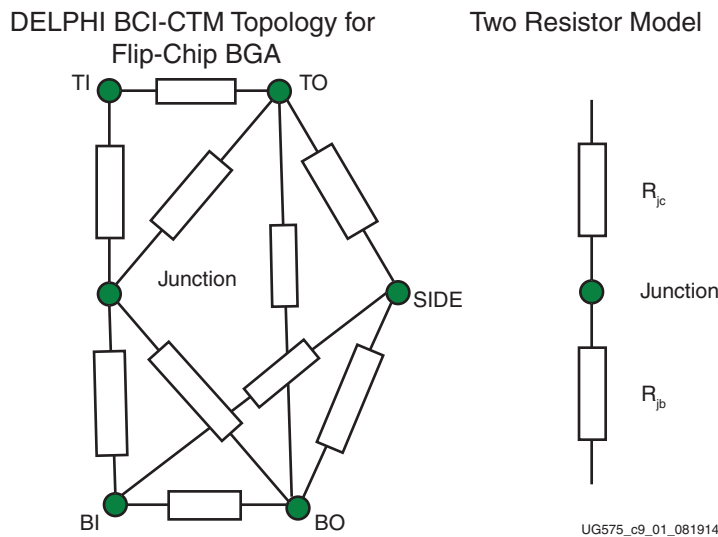

Figure 9-1: Thermal Model Topologies



RECOMMENDED: Xilinx recommends use of the Delphi thermal model during thermal modeling of a package. The Delphi thermal model includes consideration of the thermal interface material parameters and the manufacture variation on the thermal solution. Examples of manufacture variations include the tolerance in airflow from a fan, the tolerance on performance of the heat pipe and vapor chamber, and the manufacture variation of the attachment of fins to the heat-sink base and the flatness of the surface.

Thermal Management Strategy

Introduction

As described in this section, Xilinx relies on a multi-pronged approach to consuming less power and dissipating heat for systems using UltraScale™ and UltraScale+™ devices.

Flip-Chip Packages

UltraScale and UltraScale+ devices are offered in flip-chip BGA packages, which present a low thermal path. With the exception of the bare-die packages, the flip-chip BGA packages incorporate a heat spreader with an additional thermal interface material (TIM), as shown in Figure 10-1.

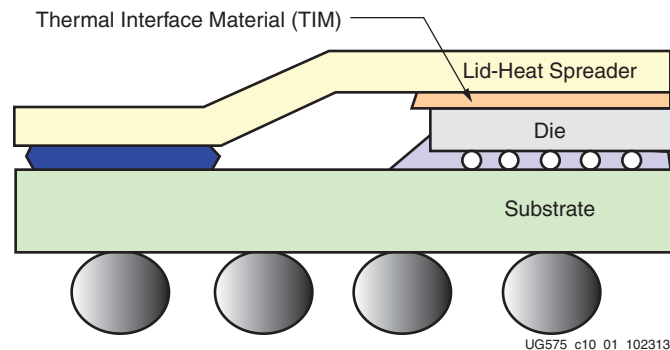

Figure 10-1: Heat Spreader with Thermal Interface Material

Materials with better thermal conductivity and consistent process deliver low thermal resistance to the heat spreader.

A parallel effort to ensure optimized package electrical return paths produces the added benefit of enhanced power and ground plane arrangement in the packages. A boost in copper density on the planes improves the overall thermal conductivity through the laminate. In addition, the extra dense and distributed via fields in the package increase the vertical thermal conductivity.

System Level Heat Sink Solutions

To complete a comprehensive thermal management strategy, an overall thermal budget that includes custom or OEM heat-sink solutions depends on the physical and mechanical constraints of the system. A heat-sink solution, managed by the system-level designer, should be tailored to the design and specific system constraints. This includes understanding the inherent device capabilities for delivering heat to the surface.

By considering the system's physical, mechanical, and environmental constraints, the overall thermal budget is maintained and does not exceed the device's maximum operating temperature. The heat sink is an integral part of the thermal management solution to maintain a safe operating temperature. As a result, the system-level designer must be aware of the following:

- For lidless packages, the nominal stiffener height can be different from the height of the die. Therefore, the heat sink must have an island to contact the die.
- Especially for lidless packages, Xilinx advises against direct use of the θ_{JC} parameters (see [Table 9-1](#)) to determine the thermal performance of the device in your application. The calculation of these parameters are done in accordance with the JEDEC standard JESD51 where system parameters differ greatly from most applications. Instead, run thermal simulations of the system in worst-case environmental conditions using Delphi thermal models, which more accurately represent the device thermal performance under all boundary conditions.
- Consider the mechanical specifications of the package as well as the selection of the thermal interface between the die and the thermal management solution to ensure the lowest thermal contact resistance.
- The total thermal contact of the thermal interface material is determined based on parameters from the thermal interface supplier's data sheet.
- See the applied pressure recommendation on [page 428](#). Lower pressure runs the risk of poor thermal contact and higher pressure runs the risk of damaging the device; therefore, strict control of pressure is required.
- Consider all uncertainties in thermal modeling, including manufacturing variations from the thermal solutions (for example, fan airflow tolerance, heat pipe or vapor chamber performance tolerance, variation of the attachment of fins to heat sink base, and surface flatness).

Thermal Interface Material

When installing heat sinks for UltraScale or UltraScale+ devices, a suitable thermal interface material must be used. This thermal material significantly aids the transfer of heat from the component to the heat sink.

For bare-die flip-chip BGAs, the surface of the silicon contacts the heat sink. For lidded flip-chip BGAs, the lid contacts the heat sink. The surface size of the bare-die flip-chip BGA and lidded flip-chip BGAs are different. Xilinx recommends a different type of thermal material for long-term use with each type of flip-chip BGAs package.

Thermal interface material is needed because even the largest heat sink and fan cannot effectively cool an UltraScale or UltraScale+ device unless there is good physical contact between the base of the heat sink and the top of the UltraScale or UltraScale+ device. The surfaces of both the heat sink and the UltraScale or UltraScale+ device silicon are not absolutely smooth. This surface roughness is observed when examined at a microscopic level. Because surface roughness reduces the effective contact area, attaching a heat sink without a thermal interface material is not sufficient due to inadequate surface contact.

A thermal interface material such as phase-change material, thermal grease, or thermal pads fills these gaps and allows effective transference of heat between the UltraScale or UltraScale+ device die and the heat sink.

The selection of the thermal interface material between the package and the thermal management solution is critical to ensure the lowest thermal contact resistance. Therefore, the following parameters must be considered.

1. The flatness of the lid and the flatness of the contact surface of the thermal solution.
2. The applied pressure of the thermal solution on the package, which must be within the allowable maximum pressure that can be applied on the package.
3. The total thermal contact of the thermal interface material. This value is determined based on the parameters in [step 1](#) and [step 2](#), which are published in the data sheet of the thermal interface supplier.

Types of TIM

There are many type of TIM available for sale. The most commonly used thermal interface materials are listed.

- Thermal grease
- Thermal pads
- Phase-change material
- Thermal paste
- Thermal adhesives
- Thermal tape

Guidelines for Thermal Interface Materials

Five factors affect the choice, use, and performance of the interface material used between the processor and the heat sink:

- [Thermal Conductivity of the Material](#)
- [Electrical Conductivity of the Material](#)
- [Spreading Characteristics of the Material](#)
- [Long-Term Stability and Reliability of the Material](#)
- [Ease of Application](#)
- [Applied Pressure from Heat Sink to the Package via Thermal Interface Materials](#)

Thermal Conductivity of the Material

Thermal conductivity is the quantified ability of any material to transfer heat. The thermal conductivity of the interface material has a significant impact on its thermal performance. The higher the thermal conductivity, the more efficient the material is at transferring heat. Materials that have a lower thermal conductivity are less efficient at transferring heat, causing a higher temperature differential to exist across the interface. To overcome this less efficient heat transfer, a better cooling solution (typically, a more costly solution) must be used to achieve the desired heat dissipation.

Electrical Conductivity of the Material

Some metal-based TIM compounds are electrically conductive. Ceramic-based compounds are typically not electrically conductive. Manufacturers produce metal-based compounds with low-electrical conductivity, but some of these materials are not completely electrically inert. Metal-based thermal compounds are not hazardous to an UltraScale or UltraScale+ device die itself, but other elements on an UltraScale or UltraScale+ device or the motherboard can be at risk if they become contaminated by the compound. For this reason, Xilinx does not recommend the use of electrically conductive thermal interface material.

Spreading Characteristics of the Material

The spreading characteristics of the thermal interface material determines its ability, under the pressure of the mounted heat sink, to spread and fill in or eliminate the air gaps between the UltraScale or UltraScale+ device and the heat sink. Because air is a very poor thermal conductor, the more completely the interface material fills the gaps, the greater the heat transference.

Long-Term Stability and Reliability of the Material

The long-term stability and reliability of the thermal interface material is described as the ability to provide a sufficient thermal conductance even after an extended time or extensive. Low-quality compounds can harden or leak out over time (the pump-out effect), leading to overheating or premature failure of the UltraScale or UltraScale+ device. High-quality compounds provide a stable and reliable thermal interface material throughout the lifetime of the device. Thermal greases with higher viscosities are typically more resistant to pump out effects on bare-die devices.

Ease of Application

A spreadable thermal grease requires the surface mount supplier to carefully use the appropriate amount of material. Too much or too little material can cause problems. The thermal pad is a fixed size and is therefore easier to apply in a consistent manner.

Applied Pressure from Heat Sink to the Package via Thermal Interface Materials



RECOMMENDED: *Xilinx recommends that the applied pressure on the package be in the range of 20 to 50 psi for optimum performance of the thermal interface material (TIM) between the package and the heat sink. Thermocouples should not be present between the package and the heat sink, as their presence will degrade the thermal contact and result in incorrect thermal measurements. The best practice is to select the appropriate pressure (in the 20 to 50 psi range) for the optimum thermal contact performance between the package and the thermal system solution, and the mechanical integrity of the package (with the thermal solution to pass all mechanical stress and vibration qualification tests).*



RECOMMENDED: Xilinx recommends using dynamic mounting around the four corners of the device package. On the PCB, use a bracket clip as part of the heat sink attachment to provide mechanical package support. See [Figure 10-2](#).

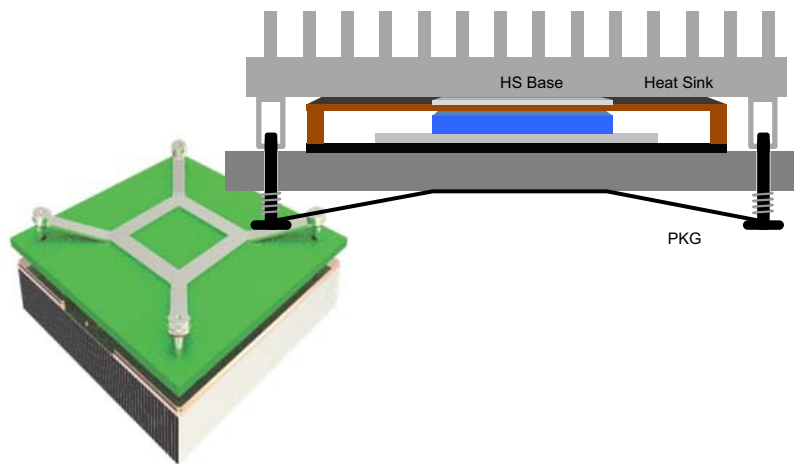

X15431-111316

Figure 10-2: Dynamic Mounting and Bracket Clips on Heat Sink Attachment

Heat Sink Removal

When removing or reworking heat sinks, the phase-change material residue must be removed from the surface of the die. Laird Technologies, Inc. provides the following guidance for complete removal of the phase-change material from the component.

Instructions for Removal of Phase-change Material

1. [Separate the Components](#)
2. [Scrape Away Thick Residue](#)
3. [Clean Remaining Residue with Solvent](#)
4. [Working with Laird Material](#)

Separate the Components

At room temperature, if possible, use a back and forth twisting motion to break the bond between the phase-change thermal interface material and mated components (i.e., heat sink and FPGA). See [Figure 10-3](#).

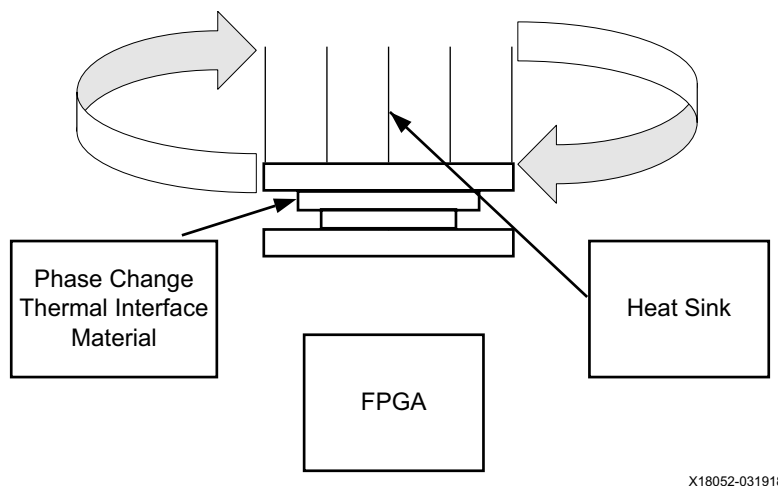

X18052-031918

Figure 10-3: Breaking the Bond between Thermal Interface Material and Mated Components

For smaller components (typically 15 mm x 15 mm or less), the bond usually breaks free easily at room temperature. For larger components, in situations where minimal movement is available, or if using fragile components, heat the component (preferred) or heat sink to about 40°C–60°C before removal.

The guideline is 40°C–60°C, however, you might find that for your application, heating to 35°C is adequate. You might prefer to heat to 70°C which makes the phase-change thermal interface material very soft and the components can be easily separated.

Scrape Away Thick Residue

For a faster clean-up once components are separated, scrape away any large residual material amounts with a plastic spatula or a wooden tongue depressor. A clean dry rag can be used to wipe away excess material.

Clean Remaining Residue with Solvent

Using a clean cloth/wipe, wet it with your choice of solvent (see the following list) and wipe away any remaining residue.

- Toluene (easiest)
- Acetone (very good)
- Isoparaffinic hydrocarbon: Isopar, Soltrol (trade names) (very good)
- Isopropyl alcohol (OK)

Working with Laird Material

Safe handling, disposal, and first-aid measures for working with phase-change material are included in the Laird Technologies material safety data sheet (MSDS). Read the MSDS before using or handling. See the Laird Technologies, Inc. website, www.lairdtech.com.

Measurement Debug

When performing in-system thermal testing, to ensure accurate data and not incur damage to the device, do not place a thermocouple in between the device and the heat sink. On the extreme side, it might cause additional mechanical and/or thermal stress to the device, leading to damage. Even if damage does not occur, it often leads to a thicker and or uneven thermal interface material thickness, leading to a thermal performance difference from a system without a thermocouple. To obtain the device temperature, use the System Monitor as a non-invasive means to get accurate device measurements while debugging the system.

Heat Sink Guidelines for Bare-die Flip-Chip Packages

Heat Sink Attachments for Bare-die FB Packages

Heat sinks can be attached to the package in multiple ways. For heat to dissipate effectively, the advantages and disadvantages of each heat sink attachment method must be considered. Factors influencing the selection of the heat sink attachment method include the package type, contact area of the heat source, and the heat sink type.

Silicon and Decoupling Capacitors Height Consideration

When designing heat sink attachments for bare-die flip-chip BGA packages, the height of the die above the substrate and also the height of decoupling capacitors must be considered (Figure 11-1). This is to prevent electrical shorting between the heat sink (metal) and the decoupling capacitors.

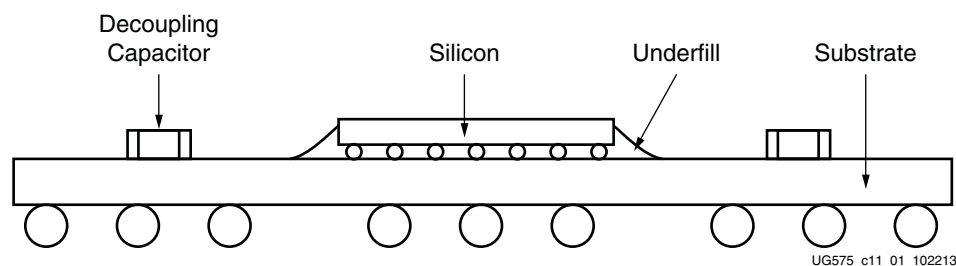

Figure 11-1: Cross Section of Bare-die Flip-chip BGA

Types of Heat Sink Attachments

There are six main methods for heat sink attachment. [Table 11-1](#) lists their advantages and disadvantages.

- [Thermal tape](#)
- [Thermally conductive adhesive or glue](#)
- [Wire form Z-clips](#)
- [Plastic clip-ons](#)
- [Threaded stand-offs \(PEMs\) and compression springs](#)
- [Push-pins and compression springs](#)

Table 11-1: Heat Sink Attachment Methods

Attachment Method	Advantages	Disadvantages
Thermal tape	<ul style="list-style-type: none"> • Generally easy to attach and is inexpensive. • Lowest cost approach for aluminum heat sink attachment. • No additional space required on the PCB. 	<ul style="list-style-type: none"> • The surfaces of the heat sink and the chip must be very clean to allow the tape to bond correctly. • Because of the small contact area, the tape might not provide sufficient bond strength. • Tape is a moderate to low thermal conductor that could affect the thermal performance.
Thermally conductive adhesive or glue	<ul style="list-style-type: none"> • Outstanding mechanical adhesion. • Fairly inexpensive, costs a little more than tape. • No additional space required on the PCB. 	<ul style="list-style-type: none"> • Adhesive application process is challenging and it is difficult to control the amount of adhesive to use. • Difficult to rework. • Because of the small contact area, the adhesive might not provide sufficient bond strength.
Wire form Z-clips	<ul style="list-style-type: none"> • It provides a strong and secure mechanical attachment. In environments that require shock and vibration testing, this type of strong mechanical attachment is necessary. • Easy to apply and remove. Does not cause the semiconductors to be destroyed (epoxy and occasionally tape can destroy the device). • It applies a preload onto the thermal interface material (TIM). Pre-loads actually improve thermal performance. 	<ul style="list-style-type: none"> • Requires additional space on the PCB for anchor locations.

Table 11-1: Heat Sink Attachment Methods (Cont'd)

Attachment Method	Advantages	Disadvantages
Plastic clip-ons	<ul style="list-style-type: none"> • Suitable for designs where space on the PCB is limited. • Easy to rework by allowing heat sinks to be easily removed and reapplied without damaging the PCB board. • Can provide a strong enough mechanical attachment to pass shock and vibration test. 	<ul style="list-style-type: none"> • Needs a keep out area around the silicon devices to use the clip. • Caution is required when installing or removing clip-ons because localized stress can damage the solder balls or chip substrate.
Threaded stand-offs (PEMs) and compression springs	<ul style="list-style-type: none"> • Provides stable attachments to heat source and transfers load to the PCB, backing plate, or chassis. • Suitable for high mass heat sinks. • Allows for tight control over mounting force and load placed on chip and solder balls. 	<ul style="list-style-type: none"> • Holes are required in the PCB taking valuable space that can be used for trace lines. • Tends to be expensive, especially since holes need to be drilled or predrilled onto the PCB board to use stand-offs.
Push-pins and compression springs	<ul style="list-style-type: none"> • Provides a stable attachment to a heat source and transfers load to the PCB. • Allows for tight control over mounting force and load placed on chip and solder balls. 	<ul style="list-style-type: none"> • Requires additional space on the PCB for push-pin locations.

Heat Sink Attachment

Component Pick-up Tool Consideration

For pick-and-place machines to place bare-die flip-chip BGAs onto PCBs, Xilinx recommends using soft tips or suction cups for the nozzles. This prevents chipping, scratching, or even cracking of the bare die (Figure 11-2).

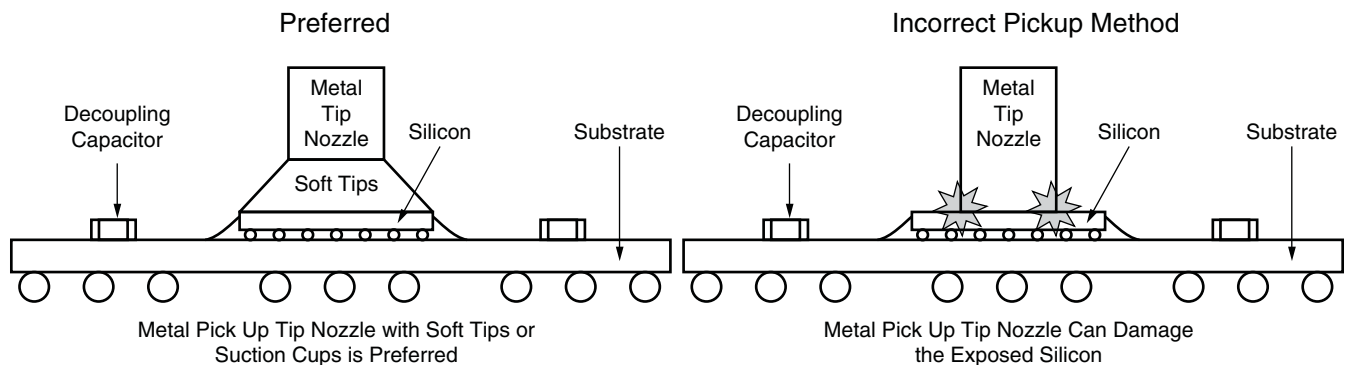

UG575_c11_02_102213

Figure 11-2: Recommended Method For Using Pick-up Tools

Heat Sink Attachment Process Considerations

After the component is placed onto the PCBs, when attaching a heat sink to the bare-die package, the factors in Table 11-2 must be carefully considered (see Figure 11-3).

Table 11-2: Heat Sink Attachment Considerations

Consideration(s)	Effect(s)	Recommendation(s)
In heat sink attach process, what factors can cause damage to the exposed die and passive capacitors?	<ul style="list-style-type: none"> • Uneven heat sink placement • Uneven TIM thickness • Uneven force applied when placing heat sink placement 	<ul style="list-style-type: none"> • Even heat sink placement • Even TIM thickness • Even force applied when placing heat sink placement
Does the heat sink tilt or tip the post attachment?	Uneven heat sink placement will damage the silicon and can cause field failures.	<ul style="list-style-type: none"> • Careful handling not to contact the heat sink with the post attachment. • Use a fixture to hold the heat sink in place with post attachment until it is glued to the silicon.

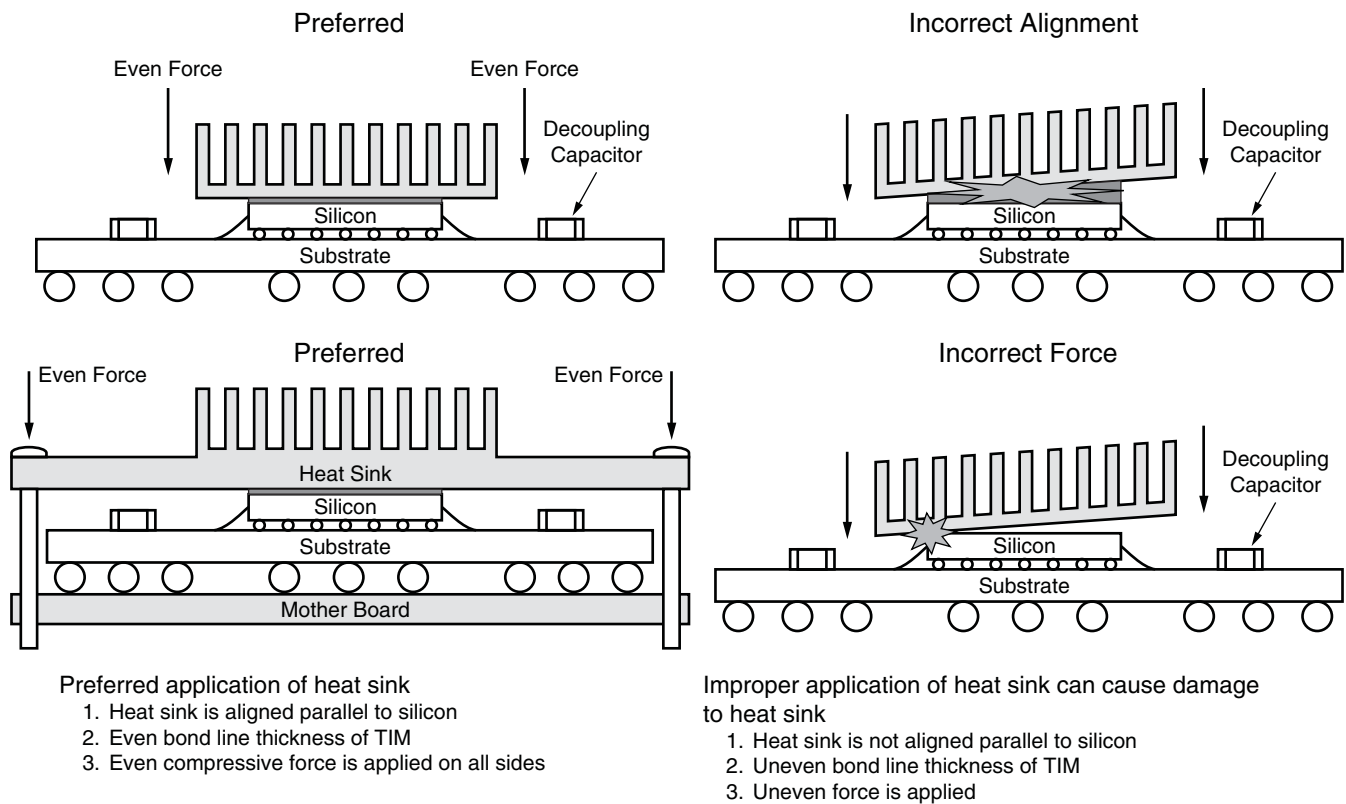

UG575_c11_03_110513

Figure 11-3: Recommended Application of Heat Sink

Standard Heat Sink Attach Process with Thermal Conductive Adhesive

Prior to attaching the heat sink, the UltraScale or UltraScale+ device needs be surface mounted on the motherboard.

1. Place the motherboard into a jig or a fixture to hold the motherboard steady to prevent any movement during the heat sink attachment process.
2. Thermoset material (electrically non-conductive) is applied over the backside surface of silicon in a pattern using automated dispensing equipment. Automated dispensers are often used to provide a stable process speed at a relatively low cost. The optimum dispensing pattern needs to be determined by the SMT supplier.

Note: Minimal volume coverage of the backside of the silicon can result in non-optimum heat transfer.

3. The heat sink is placed on the backside of the silicon with a pick and place machine. A uniform pressure is applied over the heat sink to the backside of the silicon. As the heat sink is placed, the adhesive spreads to cover the backside silicon. A force transducer is normally used to measure and limit the placement force.
4. The epoxy is cured with heat at a defined time.

Note: The epoxy curing temperature and time is based on manufacturer's specifications.

Standard Heat Sink Attach Process with Thermal Adhesive Tape

Prior to attaching the heat sink, the UltraScale or UltraScale+ device needs be surface mounted on the motherboard.

1. Place the motherboard into a jig or a fixture to hold the motherboard steady to prevent any movement during the heat sink attachment process.
2. Thermal adhesive tape cut to the size of the heat sink is applied on the underside of the heat sink at a modest angle with the use of a squeegee rubber roller. Apply pressure to help reduce the possibility of air entrapment under the tape during application.
3. The heat sink is placed on the backside of the silicon with a pick and place machine. A uniform pressure is applied over the heat sink to the backside of the silicon. As the heat sink is placed, the thermal adhesive tape is glued to the backside of the silicon. A force transducer is normally used to measure and limit the placement force.
4. A uniform and constant pressure is applied uniformly over the heat sink and held for a defined time.

Note: The thermal adhesive tape hold time is based on manufacturer's specifications.

Push-Pin and Shoulder Screw Heat Sink Attachment Process with Phase Change Material (PCM) Application

Prior to attaching the heat sink, the UltraScale or UltraScale+ device needs be surface mounted on the motherboard.

1. Place the motherboard into a jig or a fixture to hold the motherboard steady to prevent any movement during the heat sink attachment process.

Note: The jig or fixture needs to account for the push pin depth of the heat sink.

2. PCM tape, cut to the size of the heat sink, is applied on the underside of the heat sink at a modest angle with the use of a squeegee rubber roller. Apply pressure to help reduce the possibility of air entrapment under the tape during application.
3. Using the push-pin tool, heat sinks are applied over the packages ensuring a pin locking action with the PCB holes. The compression load from springs applies the appropriate mounting pressure required for proper thermal interface material performance.

Note: Heat sinks must not tilt during installation. This process cannot be automated due to the mechanical locking action which requires manual handling. The PCB drill hole tolerances need to be close enough to eliminate any issues concerning the heat sink attachment.

Mechanical and Thermal Design Guidelines for Lidless Flip-chip Packages

Introduction

This chapter discusses the challenges of thermal management including reducing device thermal resistance and optimal power dissipation without an increase in junction temperature. The lidless UltraScale+ FPGA packages target the largest devices while allowing for cooler operation temperatures (up to 10°C) with the same power dissipation.

Precise mechanical design and component thermal management is vital for device and system performance. This document presents the unique thermal and mechanical design requirements for lidless devices.

Lidless Flip-Chip Packages

The Xilinx flip-chip BGA packages exhibit a low-resistance thermal path that adequately cools devices. These packages incorporate a heat spreader lid with additional thermal interface material (Figure 12-1).

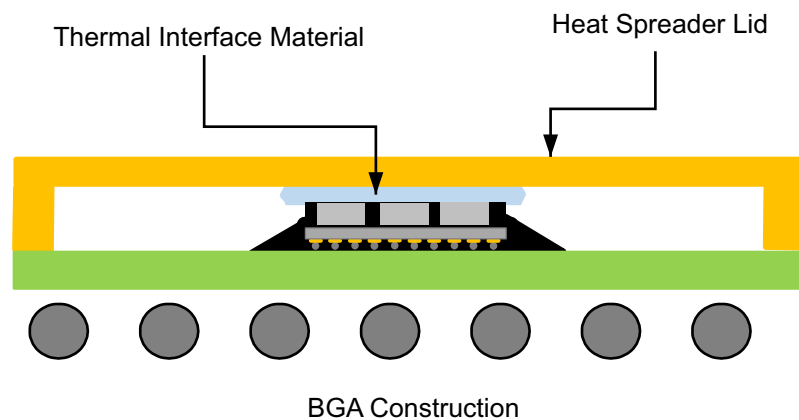

Figure 12-1: Flip-Chip BGA Construction with Heat Spreader and Thermal Interface Material

Materials with high thermal conductivity and consistent process applications deliver low thermal resistance up to the heat spreader. A parallel effort to ensure optimized package electrical return paths produces an enhanced power and ground plane arrangement in the package. A boost in copper density on the planes improves the overall thermal conductivity through the laminate. The extra density and distribution via fields in the package also increases the vertical thermal conductivity.

The lidless packages ([Figure 12-2](#)) offer the same package substrate design with electrical and board thermal conductivity similar to the flip-chip BGA packages. However, removing the lid (heat spreader) and the thermal interface material allows for direct contact between the external heat sink and the die. This further reduces the thermal resistance and exhibits improved thermal behaviors. The use of custom passive or active heat-sink designs is facilitated by incorporating two-phase (heat pipe, vapor chamber, or even liquid) cooling methods directly adjacent to the source of the dissipated heat on the die, which allows for a more efficient means of removing the heat from the device. Consequently, the device can operate at higher ambient temperatures while in area-constrained surroundings resulting in operational power advantages.

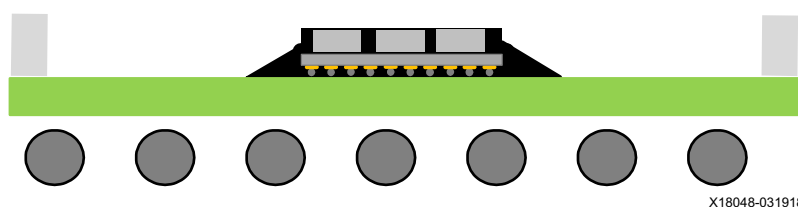

Figure 12-2: Lidless Flip-Chip BGA Construction

A unique feature of lidless packages is the addition of a stiffener ring around the periphery of the package substrate, providing additional package rigidity and helping to improve the overall package coplanarity (flatness). It also serves as a guide for the heat sink solution applied to the device. For examples, see [Figure 4-45](#), [Figure 4-46](#), and [Figure 4-47](#).

In the lidless packages, capacitors can be placed in the area surrounding the die. Contact with electrically conductive materials must be avoided because the die-side capacitors, which are only slightly shorter than the die height, could be electrically conductive. Any thermal and mechanical solution higher than the die must not interfere with the package stiffener. Therefore, the thermal solution must have an island, see [System Level Heat Sink Solutions in Chapter 10](#).

For further guidelines on mechanical and thermal designs of lidless packages, refer to XAPP1301: *Mechanical and Thermal Design Guidelines for Lidless Flip-Chip Packages Application Note* [[Ref 19](#)].

Additional Resources and Legal Notices

Xilinx Resources

For support resources such as Answers, Documentation, Downloads, and Forums, see [Xilinx Support](#).

Solution Centers

See the [Xilinx Solution Centers](#) for support on devices, software tools, and intellectual property at all stages of the design cycle. Topics include design assistance, advisories, and troubleshooting tips.

Documentation Navigator and Design Hubs

Xilinx[®] Documentation Navigator provides access to Xilinx documents, videos, and support resources, which you can filter and search to find information. To open the Xilinx Documentation Navigator (DocNav):

- From the Vivado[®] IDE, select **Help > Documentation and Tutorials**.
- On Windows, select **Start > All Programs > Xilinx Design Tools > DocNav**.
- At the Linux command prompt, enter `docnav`.

Xilinx Design Hubs provide links to documentation organized by design tasks and other topics, which you can use to learn key concepts and address frequently asked questions. To access the Design Hubs:

- In the Xilinx Documentation Navigator, click the **Design Hubs View** tab.
- On the Xilinx website, see the [Design Hubs](#) page.

Note: For more information on Documentation Navigator, see the [Documentation Navigator](#) page on the Xilinx website.

References

1. *UltraScale Architecture and Product Overview* ([DS890](#))
2. *XQ UltraScale Architecture Data Sheet Overview* ([DS895](#))
3. UltraScale device data sheets:
 - *Kintex UltraScale FPGAs Data Sheet: DC and AC Switching Characteristics* ([DS892](#))
 - *Virtex UltraScale FPGAs Data Sheet: DC and AC Switching Characteristics* ([DS893](#))
 - *Kintex UltraScale+ FPGAs Data Sheet: DC and AC Switching Characteristics* ([DS922](#))
 - *Virtex UltraScale+ FPGAs Data Sheet: DC and AC Switching Characteristics* ([DS923](#))
4. *Zynq UltraScale+ MPSoC Packaging and Pinouts User Guide* ([UG1075](#))
5. *UltraScale Architecture SelectIO Resources User Guide* ([UG571](#))
6. *UltraScale Architecture Clocking Resources User Guide* ([UG572](#))
7. *UltraScale Architecture Configuration User Guide* ([UG570](#))
8. *UltraScale Architecture GTH Transceivers User Guide* ([UG576](#))
9. *UltraScale Architecture GTY Transceivers User Guide* ([UG578](#))
10. *UltraScale Architecture System Monitor User Guide* ([UG580](#))
11. *UltraScale Architecture PCB and Pin Planning User Guide* ([UG583](#))
12. *FAQ: Top Marking Change for 7 Series, UltraScale, and UltraScale+ Products* ([XTP424](#))
13. *UltraScale Architecture FPGAs Memory IP Product Guide* ([PG150](#))
14. *UltraScale Devices Gen3 Integrated Block for PCI Express Product Guide* ([PG156](#))
15. *UltraScale+ Devices Integrated Block for PCI Express Product Guide* ([PG213](#))
16. *Integrated Interlaken 150G Product Guide* ([PG169](#))
17. *UltraScale Devices Integrated Block for 100G Ethernet Product Guide* ([PG165](#))
18. *UltraScale+ Devices Integrated 100G Ethernet Subsystem Product Guide* ([PG203](#))
19. *Mechanical and Thermal Design Guidelines for Lidless Flip-Chip Packages Application Note* ([XAPP1301](#))
20. MDDS files: Click on this link to find the [UltraScale and UltraScale+ FPGA Packaging Specifications](#). In step 2 select the product category: FPGAs and 3D ICs. In step 3, select the product type. In step 4, click on the package specifications selection to find the available MDDS files.

21. The following websites contain additional information on heat management and contact information.
 - Wakefield: www.wakefield-vette.com
 - Aavid: www.aavid.com
 - Advanced Thermal Solutions: www.qats.com
 - Radian Thermal Products: www.radianheatsinks.com
 - Thermo Cool: www.thermoolcorp.com
 - CTS: www.ctscorp.com
22. Refer to the following websites for interface material sources:
 - Henkel: www.henkel.com
 - Bergquist Company: www.bergquistcompany.com
 - AOS Thermal Compound: www.aosco.com
 - Chomerics: www.chomerics.com
 - Kester: www.kester.com
23. Refer to the following websites for CFD tools Xilinx supports with thermal models.
 - Mentor Flotherm: www.mentor.com/products/mechanical/flotherm/flotherm/
 - ANSYS Icepak: www.ansys.com
24. Refer to the [thermal device models](#) on xilinx.com.
25. The following papers are referenced for more information on thermal modelling.
 - Lemczyk, T.F., Mack, B., Culham, J.R. and Yovanovich, M.M., 1992, "Printed Circuit Board Trace Thermal Analysis and Effective Conductivity", ASME J. Electronic Packaging, Vol. 114, pp. 413 - 419.50.
 - Refai-Ahmed, G. and Karimanal, K., 2003, "Validation of Compact Conduction Models of BGA Under Realistic Boundary," J. of Components and Packaging Technology, Vol. 26, No. 3, pp. 610-615.
 - Sansoucy, E, Refai-Ahmed, G., and Karimanal, K., 2002, "Thermal Characterization of TBGA Package for an integration in Board Level Analysis," Eighth Intersociety on Thermal Conference Phenomena in Electronic Systems, San Diego., USA.
 - Karimanal,K and Refai-Ahmed, G., and., 2002, "Validation of Compact Conduction Models of BGA Under Realistic Boundary Conditions," Eighth Intersociety on Thermal Conference Phenomena in Electronic Systems, San Diego, USA.
 - Karimanal, K. and Refai-Ahmed, G., 2001, "Compact conduction Model (CCM) of Microelectronic Packages- A BGA Validation Study," APACK Conference on Advance in Packaging, Singapore.

Please Read: Important Legal Notices

The information disclosed to you hereunder (the "Materials") is provided solely for the selection and use of Xilinx products. To the maximum extent permitted by applicable law: (1) Materials are made available "AS IS" and with all faults, Xilinx hereby DISCLAIMS ALL WARRANTIES AND CONDITIONS, EXPRESS, IMPLIED, OR STATUTORY, INCLUDING BUT NOT LIMITED TO WARRANTIES OF MERCHANTABILITY, NON-INFRINGEMENT, OR FITNESS FOR ANY PARTICULAR PURPOSE; and (2) Xilinx shall not be liable (whether in contract or tort, including negligence, or under any other theory of liability) for any loss or damage of any kind or nature related to, arising under, or in connection with, the Materials (including your use of the Materials), including for any direct, indirect, special, incidental, or consequential loss or damage (including loss of data, profits, goodwill, or any type of loss or damage suffered as a result of any action brought by a third party) even if such damage or loss was reasonably foreseeable or Xilinx had been advised of the possibility of the same. Xilinx assumes no obligation to correct any errors contained in the Materials or to notify you of updates to the Materials or to product specifications. You may not reproduce, modify, distribute, or publicly display the Materials without prior written consent. Certain products are subject to the terms and conditions of Xilinx's limited warranty, please refer to Xilinx's Terms of Sale which can be viewed at www.xilinx.com/legal.htm#tos; IP cores may be subject to warranty and support terms contained in a license issued to you by Xilinx. Xilinx products are not designed or intended to be fail-safe or for use in any application requiring fail-safe performance; you assume sole risk and liability for use of Xilinx products in such critical applications, please refer to Xilinx's Terms of Sale which can be viewed at www.xilinx.com/legal.htm#tos.

AUTOMOTIVE APPLICATIONS DISCLAIMER

AUTOMOTIVE PRODUCTS (IDENTIFIED AS "XA" IN THE PART NUMBER) ARE NOT WARRANTED FOR USE IN THE DEPLOYMENT OF AIRBAGS OR FOR USE IN APPLICATIONS THAT AFFECT CONTROL OF A VEHICLE ("SAFETY APPLICATION") UNLESS THERE IS A SAFETY CONCEPT OR REDUNDANCY FEATURE CONSISTENT WITH THE ISO 26262 AUTOMOTIVE SAFETY STANDARD ("SAFETY DESIGN"). CUSTOMER SHALL, PRIOR TO USING OR DISTRIBUTING ANY SYSTEMS THAT INCORPORATE PRODUCTS, THOROUGHLY TEST SUCH SYSTEMS FOR SAFETY PURPOSES. USE OF PRODUCTS IN A SAFETY APPLICATION WITHOUT A SAFETY DESIGN IS FULLY AT THE RISK OF CUSTOMER, SUBJECT ONLY TO APPLICABLE LAWS AND REGULATIONS GOVERNING LIMITATIONS ON PRODUCT LIABILITY.

© Copyright 2013–2019 Xilinx, Inc. Xilinx, the Xilinx logo, Alveo, Artix, ISE, Kintex, Spartan, Versal, Virtex, Vivado, Zynq, and other designated brands included herein are trademarks of Xilinx in the United States and other countries. All other trademarks are the property of their respective owners.