

---

## *Micropower Ultra-Sensitive Hall-Effect Switch*

---

### **Discontinued Product**

This device is no longer in production. The device should not be purchased for new design applications. Samples are no longer available.

Date of status change: June 2, 2014

#### **Recommended Substitutions:**

*For existing customer transition, and for new customers or new applications, contact Allegro Sales.*

---

NOTE: For detailed information on purchasing options, contact your local Allegro field applications engineer or sales representative.

---

*Allegro MicroSystems, LLC reserves the right to make, from time to time, revisions to the anticipated product life cycle plan for a product to accommodate changes in production capabilities, alternative product availabilities, or market demand. The information included herein is believed to be accurate and reliable. However, Allegro MicroSystems, LLC assumes no responsibility for its use; nor for any infringements of patents or other rights of third parties which may result from its use.*

---

# Micropower Ultra-Sensitive Hall-Effect Switch

## Features and Benefits

- Micropower operation
- Operation with either north or south pole—no magnetic orientation required during assembly
- 1.65 to 3.5 V battery operation
- Chopper stabilization
  - Superior temperature stability
  - Extremely low switchpoint drift
  - Insensitive to physical stress
- Solid state reliability
- Small size: WLCSP ( $\approx 1\text{ mm} \times 1\text{ mm} \times 0.5\text{ mm}$ )
- Complementary, push-pull outputs eliminate need for pull-up resistor

## Package: 4 pin WLCSP (suffix CG)



Not to scale

## Description

The A1172 is an ultra-sensitive, pole-independent Hall-effect switch with a latched digital output. It features operation at low supply currents and voltages, making it ideal for battery-operated electronics. The 1.65 to 3.5 V operating supply voltage and unique clocking algorithm reduce the average operating power requirements to less than 15  $\mu\text{W}$  with a 2.75 V supply.

The A1172 has two push-pull output structures. Omnipolar activation for the output function is available on each output structure. As such, either a north or south pole of sufficient strength turns the available outputs off or on. The A1172 contains two complementary outputs. Therefore, for a fixed magnetic field, one output will be in a high voltage state and one output will be in a low voltage state.

Improved stability is made possible through dynamic offset cancellation using chopper stabilization, which reduces the residual offset voltage normally caused by device overmolding, temperature dependencies, and thermal stress. This device

*Continued on the next page...*

Engineering samples available on a limited basis. Contact your local sales or applications support office for additional information.

## Functional Block Diagram

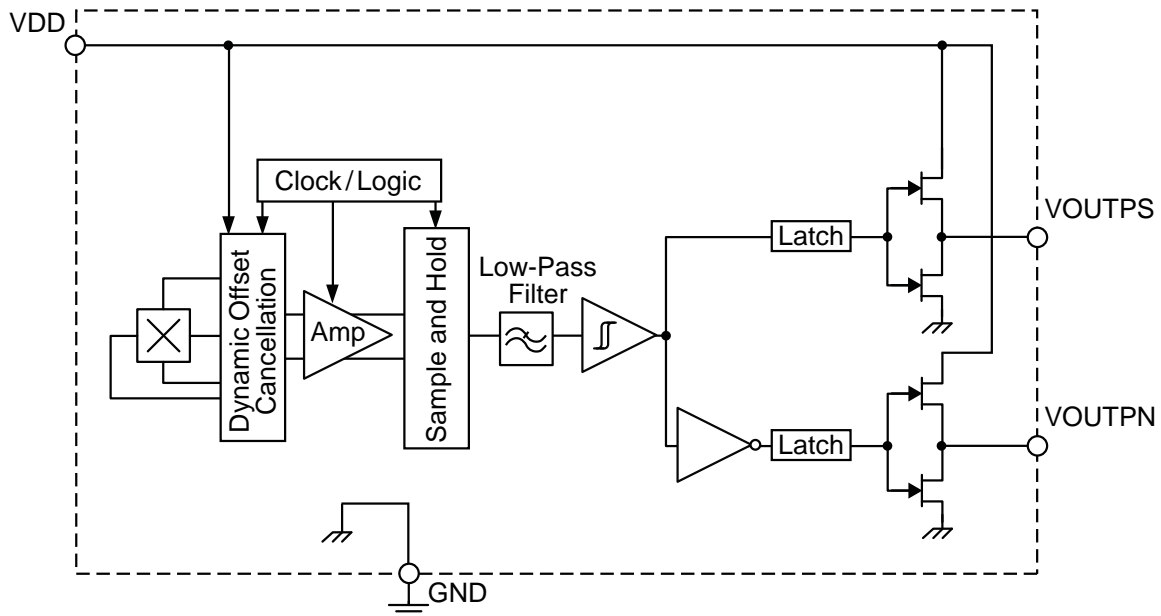

**Description (continued)**

includes, on a single silicon chip, a Hall-voltage generator, a small-signal amplifier, chopper stabilization, a latch, and a MOSFET output.

The A1172 device offers magnetically optimized solutions, suitable for most applications. The wafer level chip scale package (WLCSP) is approximately only 1 mm by 1 mm by 0.5 mm. This package is smaller than most plastic packages and reduces the printed circuit board area consumed by micropower Hall-effect switches.

**Selection Guide**

Part Number	Package <sup>1</sup>	Pb-free	Packing*
A1172ECGLT <sup>2</sup>	4 bumped wafer-level chip-scale package (WLCSP)	Pb-free chip with high-temperature solder balls (RoHS compliant)	4000 pieces per reel

<sup>1</sup>Contact Allegro™ for additional packing options.

<sup>2</sup>Allegro products sold in WLCSP package types are not intended for automotive applications.

**Absolute Maximum Ratings**

Characteristic	Symbol	Notes	Rating	Units
Supply Voltage	$V_{DD}$		5	V
Reverse Supply Voltage	$V_{RDD}$		-0.3	V
Output Off Voltage	$V_{OUTx}$		5	V
Reverse Output Voltage	$V_{ROUTx}$		-0.3	V
Output Current	$I_{OUTx(Sink)}$		-1	mA
	$I_{OUTx(Source)}$		1	mA
Magnetic Flux Density	B		Unlimited	G
Operating Ambient Temperature	$T_A$	Range E	-40 to 85	°C
Maximum Junction Temperature	$T_J(max)$		165	°C
Storage Temperature	$T_{stg}$		-65 to 170	°C

**Pin-out Diagram**

(Bump-down view)

**Terminal List Table**

Name	Number	Function
VOUTPS	A1	Push-pull output
VOUTPN	A2	Inverted push-pull output
GND	B1	Ground
VDD	B2	Connects power supply to chip

## OPERATING CHARACTERISTICS

Characteristic	Symbol	Test Conditions	Min.	Typ. <sup>1</sup>	Max.	Units
<b>Electrical Characteristics</b> valid over full operating voltage range and $T_A = 25^\circ\text{C}$						
Supply Voltage Range <sup>2</sup>	$V_{DD}$	Operating, $T_A = 25^\circ\text{C}$	1.65	–	3.5	V
Output On Voltage	$V_{OUT(SAT)}$	NMOS on, $I_{OUT} = 1\text{ mA}$ , $V_{DD} = 2.75\text{ V}$	–	100	300	mV
	$V_{OUT(HIGH)}$	PMOS on, $I_{OUT} = 1\text{ mA}$ , $V_{DD} = 2.75\text{ V}$	$V_{DD}-300$	$V_{DD}-100$	–	mV
Period	$t_{PERIOD}$		–	50	100	ms
Chopping Frequency	$f_C$		–	200	–	kHz
Supply Slew Rate <sup>3</sup>	SR		20	–	–	V/ms
Supply Current	$I_{DD(EN)}$	Chip awake (enabled)	–	–	2.0	mA
	$I_{DD(DIS)}$	Chip asleep (disabled)	–	–	8.0	$\mu\text{A}$
	$I_{DD(AV)}$	$V_{DD} = 1.80\text{ V}$	–	4	8	$\mu\text{A}$
$V_{DD} = 3.5\text{ V}$		–	6	12	$\mu\text{A}$	
<b>Magnetic Characteristics<sup>4</sup></b> at $T_A = 25^\circ\text{C}$ and $1.8\text{ V} \leq V_{DD} \leq 3.5\text{ V}$						
Operate Point	$B_{OPS}$		–	32	55	G
	$B_{OPN}$		–55	–32	–	G
Release Point	$B_{RPS}$		6	26	–	G
	$B_{RPN}$		–	–26	–6	G
Hysteresis	$B_{HYS}$	$B_{HYS} = B_{OPX} - B_{RPX}$	–	6	–	G

<sup>1</sup>Typical values at  $V_{DD} = 2.75\text{ V}$ . Performance may vary for individual units, within the specified maximum and minimum limits.

<sup>2</sup>Magnetic operate and release points vary with supply voltage.

<sup>3</sup>If  $SR < SR(\text{min})$ , then valid device output might be delayed for one Period,  $t_{PERIOD}$ , of device.

<sup>4</sup>1 gauss (G) is exactly equal to 0.1 millitesla (mT).

**THERMAL CHARACTERISTICS may require derating at maximum conditions\***

Characteristic	Symbol	Test Conditions	Value	Units
Package Thermal Resistance	$R_{\theta JA}$	On 1-layer PCB	347	$^{\circ}\text{C}/\text{W}$
		On 4-layer PCB	147	$^{\circ}\text{C}/\text{W}$

\*Additional thermal information is available on the Allegro website.

**Power Dissipation versus Ambient Temperature**

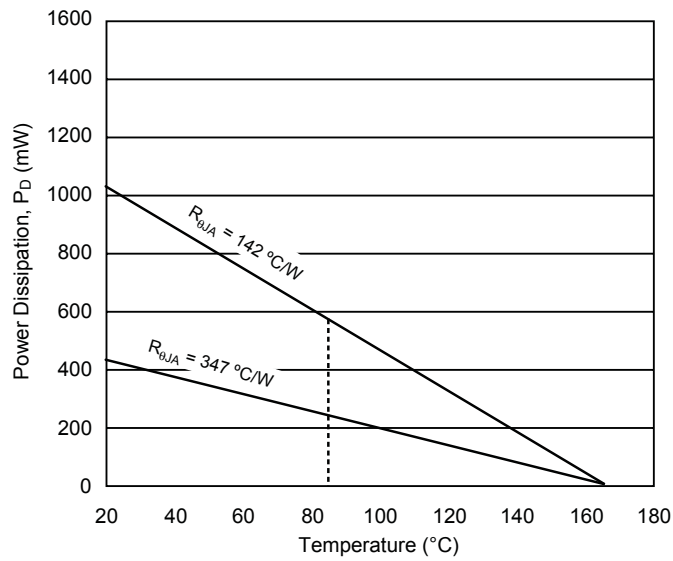

Operating Characteristics

Saturation Voltage versus Temperature

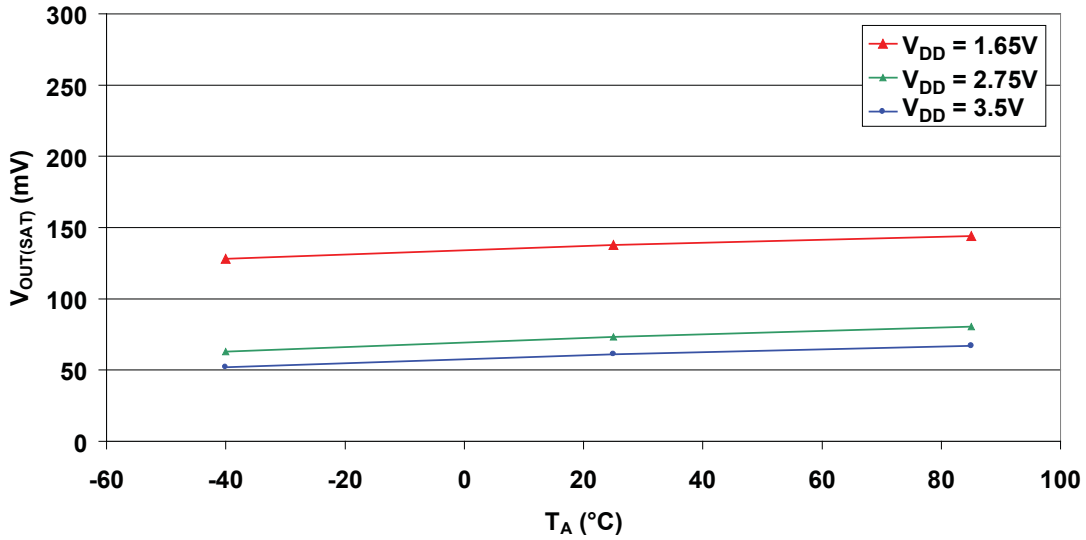

Saturation Voltage versus Supply Voltage

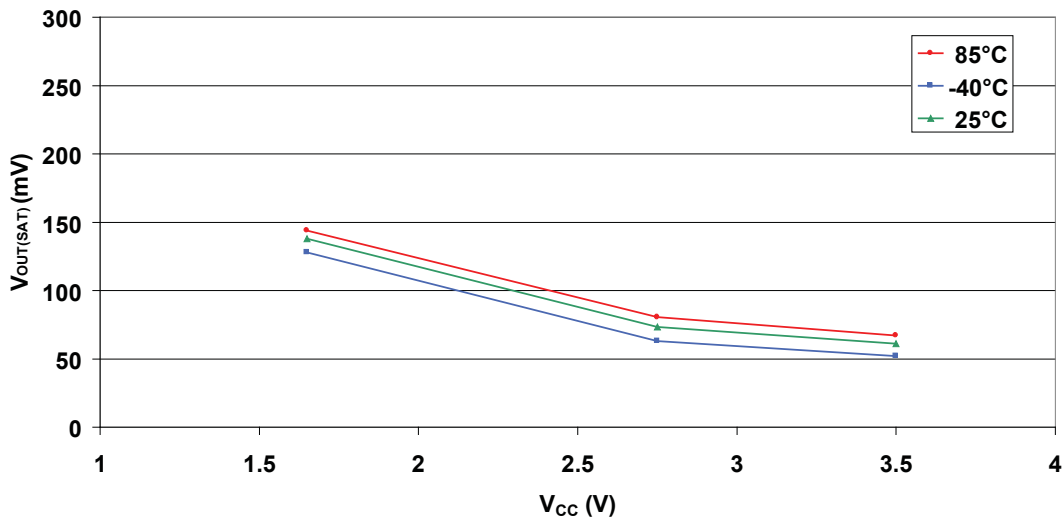

**Average Supply Current versus Temperature**

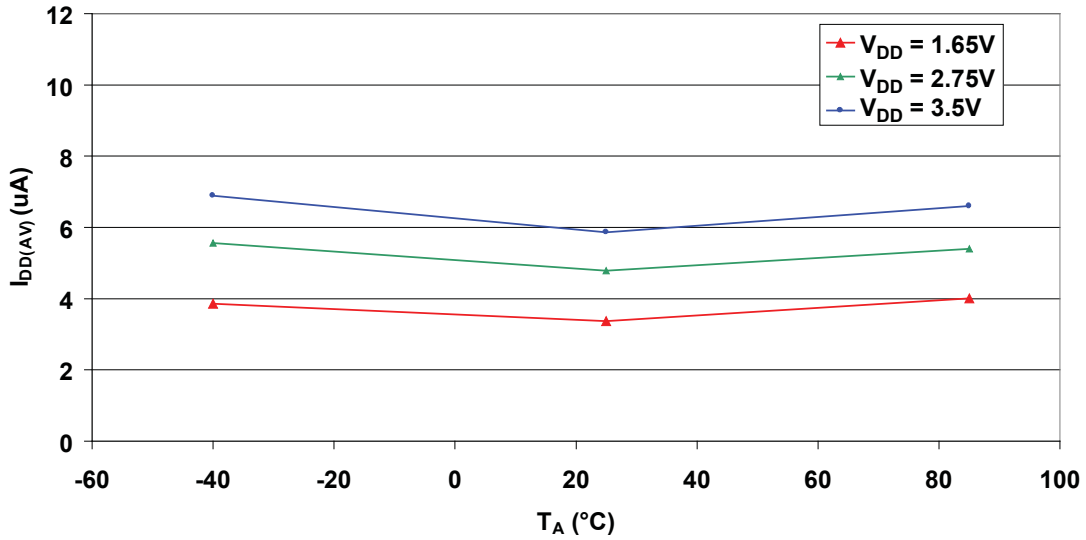

**Average Supply Current versus Supply Voltage**

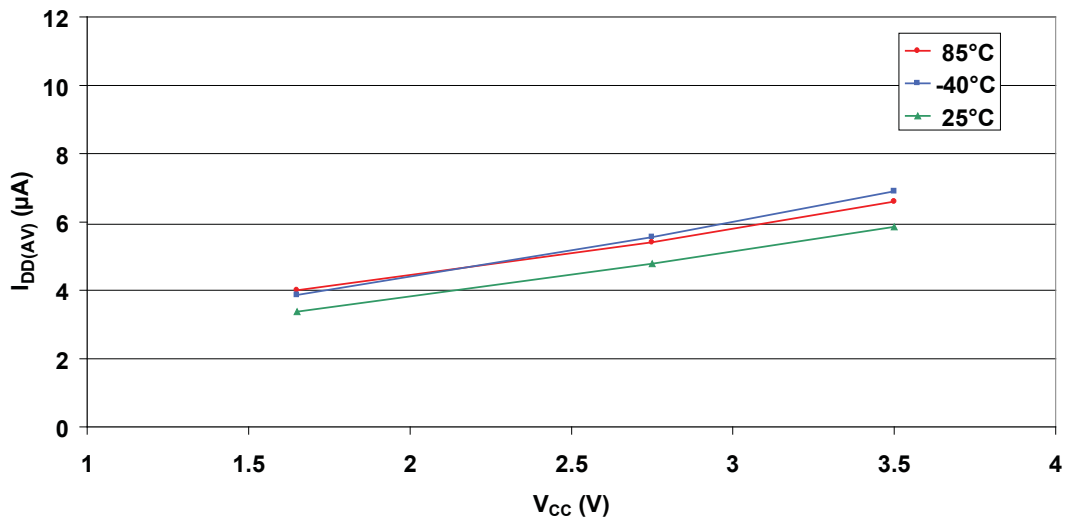

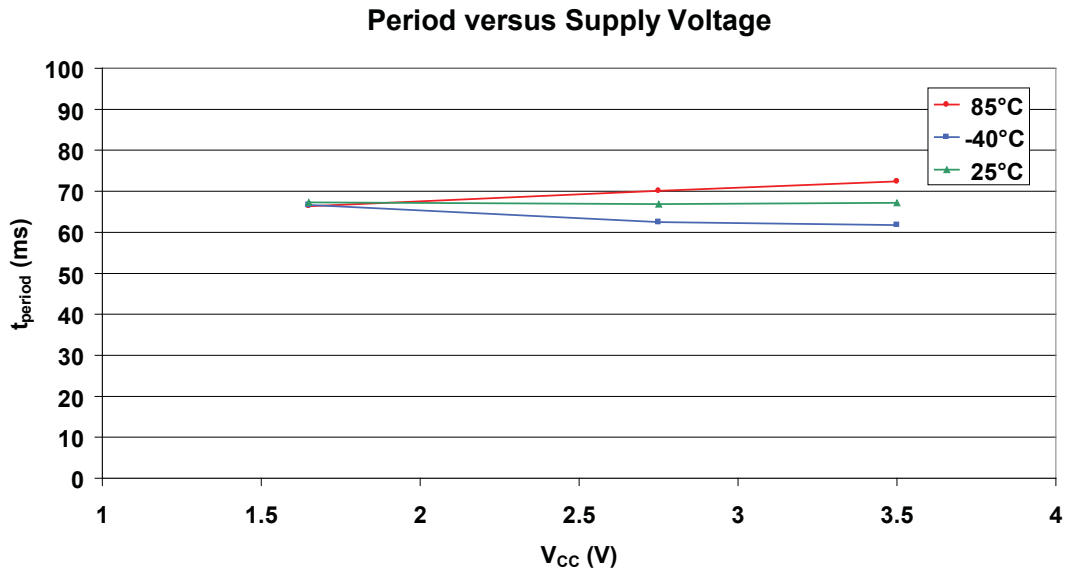
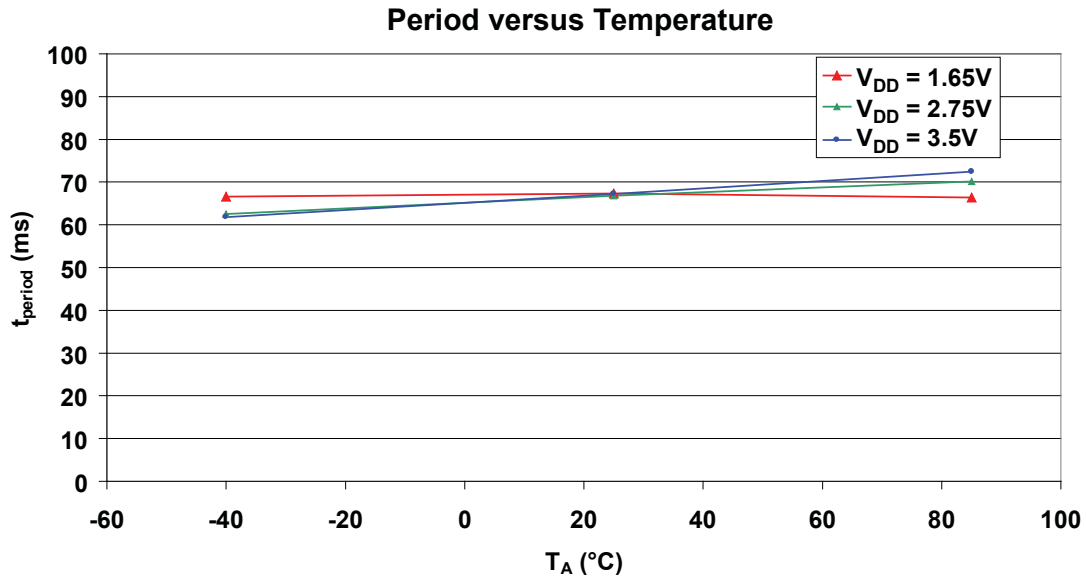



Functional Description

Low Average Power

Internal timing circuitry activates the IC for 50 μs and deactivates it for the remainder of the period (50 ms). A short awake time allows stabilization prior to the sampling and data-latching on the falling edge of the timing pulse. The output during the sleep state is latched in the last sampled state. The supply current is not affected by the output state.

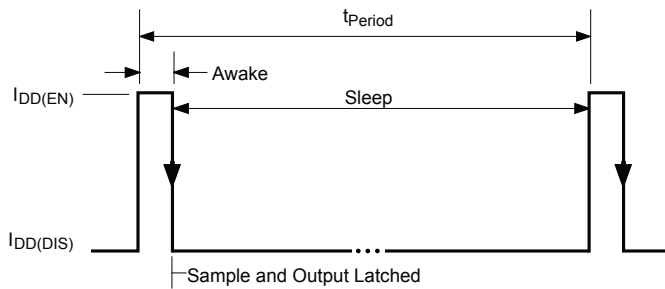

Operation

The VOUTPS output switches low (turns on) when a magnetic field perpendicular to the Hall element exceeds the operate point, B<sub>OPS</sub> (or is less than B<sub>OPN</sub>).

After turn-on, the output voltage is V<sub>OUT(SAT)</sub>. The output transistor is capable of sinking current up to the short circuit current limit, I<sub>OM</sub>, which is a minimum of 1 mA. When the magnetic field is reduced below the release point, B<sub>RPS</sub> (or increased above B<sub>RPN</sub>), the device output switches high (turns off). The pull-up transistor brings the output voltage to V<sub>OUT(HIGH)</sub>.

VOUTPN operates with the opposite output polarity. That is, the output is low (on) in the absence of a magnetic field. The output goes high (turns off) when sufficient field, of either north or south polarity, is presented to the device.

The difference in the magnetic operate and release points is the hysteresis, B<sub>HYS</sub>, of the device. This built-in hysteresis allows clean switching of the output even in the presence of external mechanical vibration and electrical noise.

The push-pull outputs are capable of sourcing or sinking a maximum of 1 mA.

Powering-on the device in a hysteresis region, between B<sub>OPX</sub> and B<sub>RPX</sub>, allows an indeterminate output state. The correct state is attained after the first excursion beyond B<sub>OPX</sub> or B<sub>RPX</sub>.

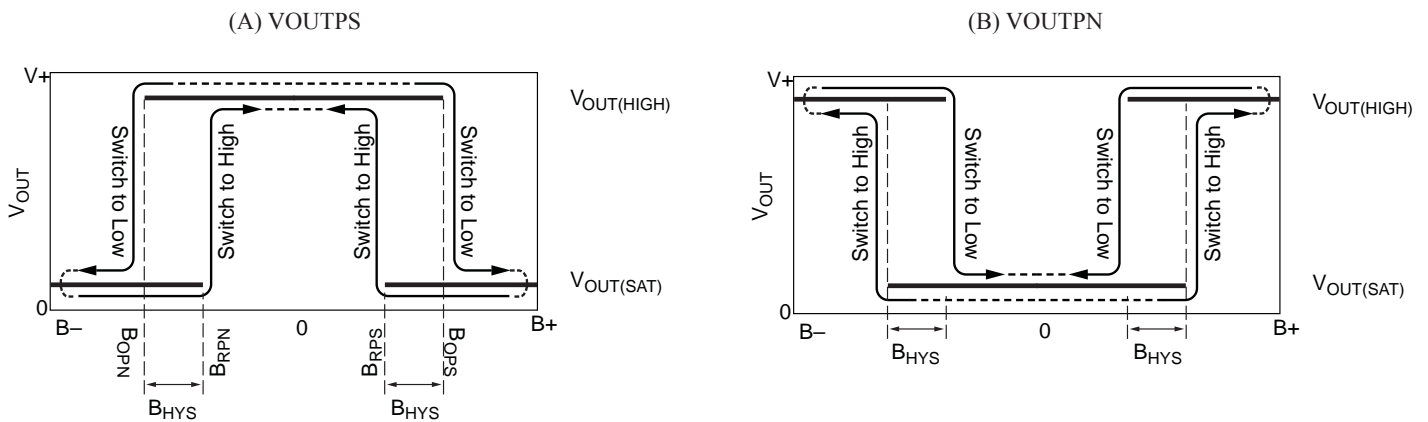

Figure 1. Switching Behavior of Omnipolar Switches. On the horizontal axis, the B+ direction indicates increasing south polarity magnetic field strength, and the B- direction indicates decreasing south polarity field strength (including the case of increasing north polarity).

## Applications

It is strongly recommended that an external bypass capacitor be connected (in close proximity to the Hall element) between the supply and ground of the device to reduce both external noise and noise generated by the chopper stabilization technique. As is shown in figure 2, a 0.1  $\mu\text{F}$  capacitor is typical.

Extensive applications information on magnets and Hall-effect devices is available in the following notes:

- Hall-Effect IC Applications Guide, AN27701
- Hall-Effect Devices: Gluing, Potting, Encapsulating, Lead Welding and Lead Forming AN27703.1
- Soldering Methods for Allegro Products (SMD and Through-Hole), AN26009

All are provided in Allegro Electronic Data Book, AMS-702, and on the Allegro Web site, [www.allegromicro.com](http://www.allegromicro.com).

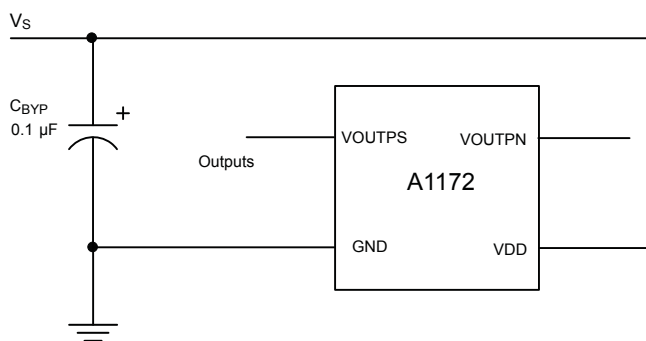
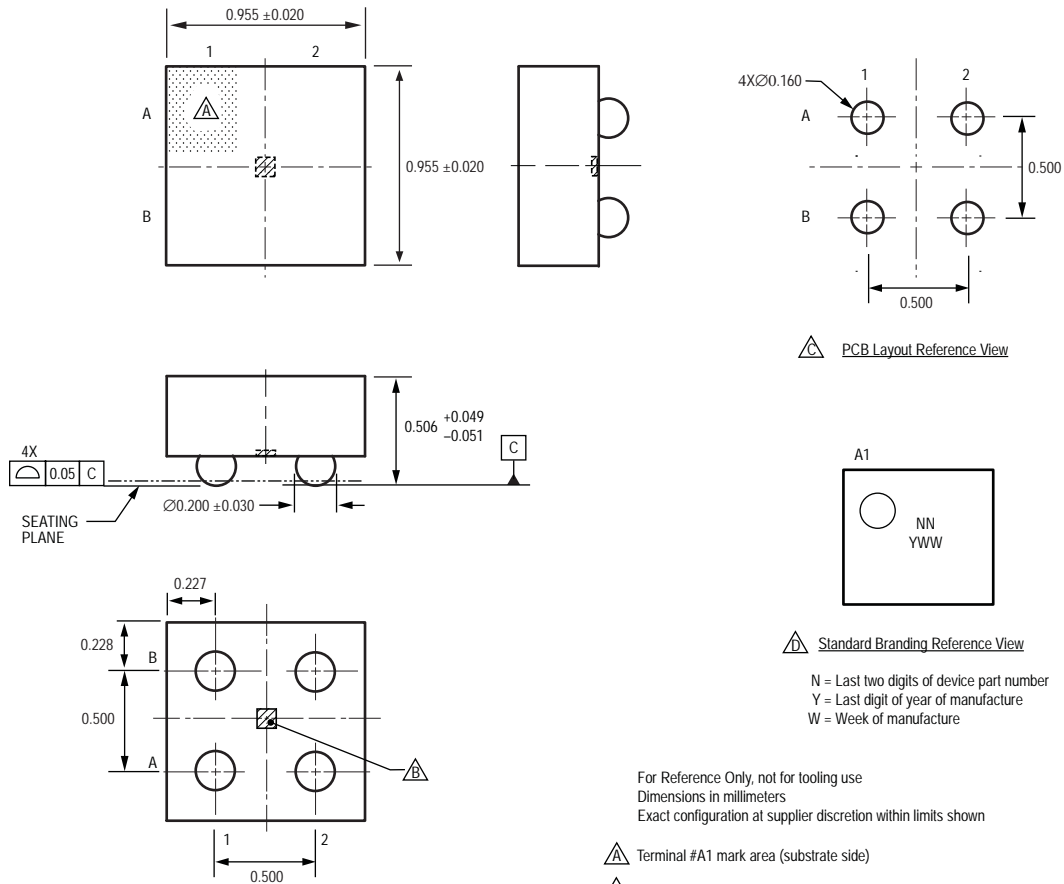



Figure 2. Typical Application Circuit

Package CG, 4-Bump WLCSP







 PCB Layout Reference View

 Standard Branding Reference View

N = Last two digits of device part number  
 Y = Last digit of year of manufacture  
 W = Week of manufacture

For Reference Only, not for tooling use  
 Dimensions in millimeters  
 Exact configuration at supplier discretion within limits shown

-  Terminal #A1 mark area (substrate side)
-  Hall element (not to scale)
-  Reference view of typical layout for solder pads  
 All pads a minimum of 0.20 mm from all adjacent pads;  
 adjust as necessary to meet application process  
 requirements and PCB layout tolerances
-  Branding scale and appearance at supplier discretion

**Revision History**

<b>Revision</b>	<b>Revision Date</b>	<b>Description of Revision</b>
Rev. 5	October 26, 2011	Update Selection Guide

Copyright ©2008-2013, Allegro MicroSystems, LLC

Allegro MicroSystems, LLC reserves the right to make, from time to time, such departures from the detail specifications as may be required to permit improvements in the performance, reliability, or manufacturability of its products. Before placing an order, the user is cautioned to verify that the information being relied upon is current.

Allegro's products are not to be used in life support devices or systems, if a failure of an Allegro product can reasonably be expected to cause the failure of that life support device or system, or to affect the safety or effectiveness of that device or system.

The information included herein is believed to be accurate and reliable. However, Allegro MicroSystems, LLC assumes no responsibility for its use; nor for any infringement of patents or other rights of third parties which may result from its use.

For the latest version of this document, visit our website:

[www.allegromicro.com](http://www.allegromicro.com)

