

General Description

The AOZ8222DI-05 is a two-line transient voltage suppressor diode designed to protect voltage sensitive electronics from high transient conditions and ESD.

This device incorporates two TVS diodes in an ultra-small DFN 1.0 x 0.6 package. During transient conditions, the TVS diodes direct the transient to ground. The AOZ8222DI-05 may be used to meet the ESD immunity requirements of IEC 61000-4-2, Level 4 (± 15 kV air, ± 8 kV contact discharge).

The AOZ8222DI-05 comes in an RoHS compliant 3-lead DFN package and is rated over a -40 °C to $+85$ °C ambient temperature range.

The ultra-small 1.0 mm x 0.6 mm x 0.5 mm DFN package makes it ideal for applications where PCB space is a premium. The small size and high ESD protection makes it ideal for protecting voltage sensitive electronics from high transient conditions and ESD.

Features

- ESD protection for high-speed data lines:
 - Exceeds IEC 61000-4-2 (ESD): ± 20 kV (air), ± 20 kV (contact)
 - Human Body Model (HBM) ± 30 kV
- Small package saves board space
- Low insertion loss
- Low clamping voltage
- Low operating voltage: 5 V

Applications

- Portable handheld devices
- Keypads, data lines, buttons
- Notebook computers
- Digital Cameras
- Portable GPS
- MP3 players



Typical Application

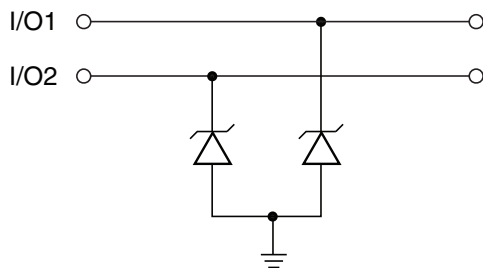

Unidirection Protection of Two Line

Pin Configuration

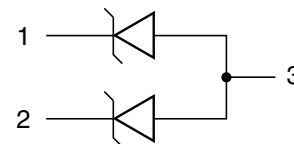

Ordering Information

Part Number	Ambient Temperature Range	Package	Environmental
AOZ8222DI-05	-40 °C to +85 °C	DFN 1.0 x 0.6-3L	Green Product



AOS Green Products use reduced levels of Halogens, and are also RoHS compliant. Please visit www.aosmd.com/media/AOSGreenPolicy.pdf for additional information.

Absolute Maximum Ratings

Exceeding the Absolute Maximum ratings may damage the device.

Parameter	AOZ8222DI-05DI-05
Peak Pulse Current, $t_p = 8/20 \mu s$	5.5 A
Peak Pulse Power, $t_p = 8/20 \mu s$	50 W
Storage Temperature (T_S)	-65 °C to +150 °C
ESD Rating per IEC61000-4-2, Contact ⁽¹⁾	± 20 kV
ESD Rating per IEC61000-4-2, Air ⁽¹⁾	± 20 kV
ESD Rating per Human Body Model ⁽²⁾	± 30 kV

Notes:

1. IEC 61000-4-2 discharge with $C_{Discharge} = 150 \text{ pF}$, $R_{Discharge} = 330 \Omega$.
2. Human Body Discharge per MIL-STD-883, Method 3015 $C_{Discharge} = 100 \text{ pF}$, $R_{Discharge} = 1.5 \text{ k}\Omega$.

Maximum Operating Ratings

Parameter	Rating
Junction Temperature (T_J)	-40 °C to +125 °C

Electrical Characteristics

$T_A = 25\text{ }^\circ\text{C}$ unless otherwise specified.

Symbol	Parameter	Conditions	Min.	Typ.	Max.	Units
V_{RWM}	Reverse Working Voltage	Between I/O and VN ⁽³⁾			5.0	V
V_{BR}	Reverse Breakdown Voltage	$I_T = 1\text{ mA}$, between I/O and VN ⁽⁴⁾	6.0			V
I_R	Reverse Leakage Current	$V_{RWM} = 5\text{ V}$, between I/O and VN			1	μA
V_F	Diode Forward Voltage	$I_F = 10\text{ mA}$	0.6	0.7	0.9	V
V_{CL}	Channel Clamp Voltage Positive Transients Negative Transients	$I_{PP} = 1\text{ A}$, $t_p = 100\text{ ns}$, any I/O pin to Ground ⁽⁵⁾⁽⁶⁾			8.0 -2.0	V V
	Channel Clamp Voltage Positive Transients Negative Transients	$I_{PP} = 5\text{ A}$, $t_p = 100\text{ ns}$, any I/O pin to Ground ⁽⁵⁾⁽⁶⁾			9.0 -5.0	V V
	Channel Clamp Voltage Positive Transients Negative Transients	$I_{PP} = 12\text{ A}$, $t_p = 100\text{ ns}$, any I/O pin to Ground ⁽⁵⁾⁽⁶⁾			10.0 -10.0	V V
C_J	Channel Input Capacitance	$V_R = 0\text{ V}$, $f = 1\text{ MHz}$, between I/O pins ⁽⁶⁾		8	9	pF
		$V_R = 0\text{ V}$, $f = 1\text{ MHz}$, any I/O pin to Ground ⁽⁶⁾		15	18	pF

Notes:

3. The working peak reverse voltage, V_{RWM} , should be equal to or greater than the DC or continuous peak operating voltage level.
4. V_{BR} is measured at the pulse test current I_T .
5. Measurements performed using a 100ns Transmission Line Pulse (TLP) system.
6. Guaranteed by design and characterization.

Typical Performance Characteristics

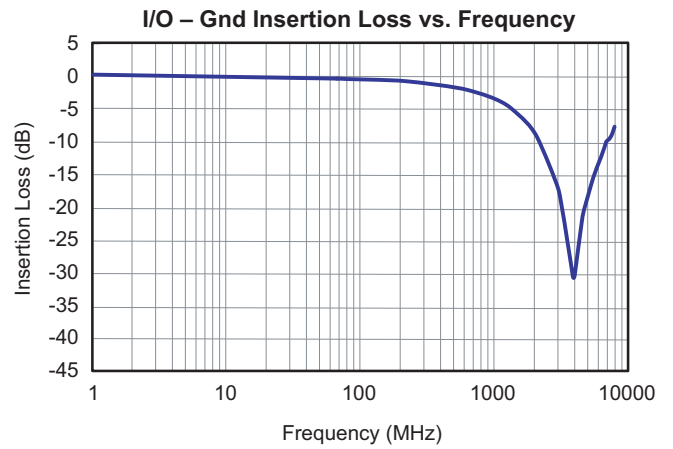
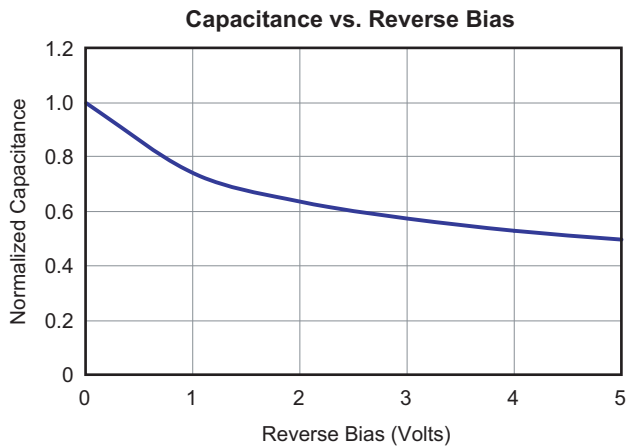
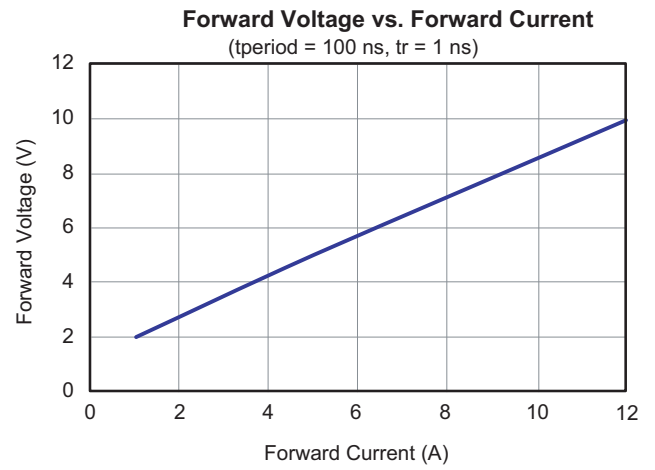
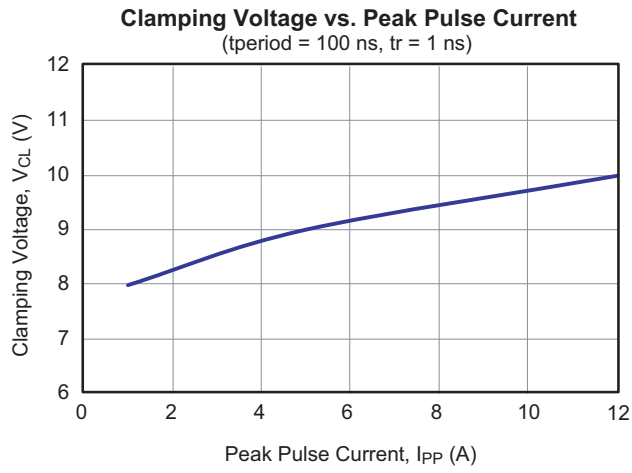

Package Dimensions, DFN1.0x0.6

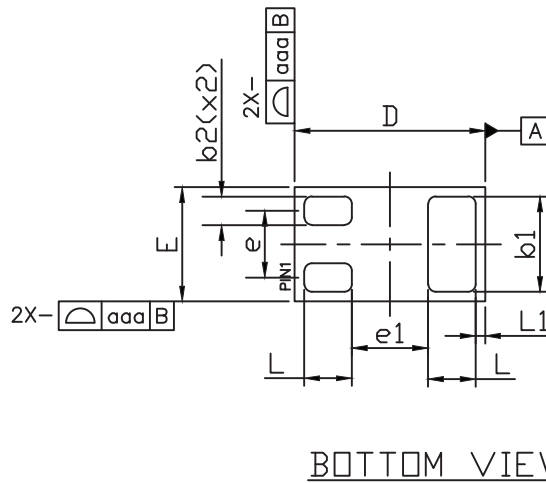
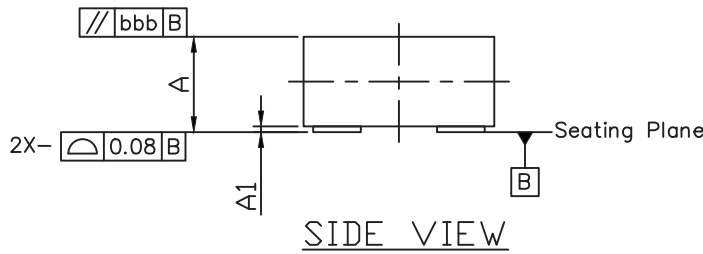

RECOMMENDED LAND PATTERN

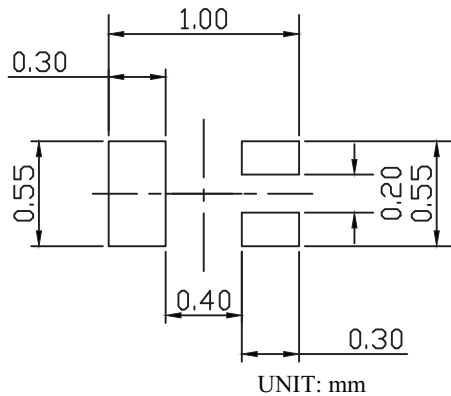

SYMBOLS	DIMENSIONS IN MILLIMETERS			DIMENSIONS IN INCHES		
	MIN	NOM	MAX	MIN	NOM	MAX
A	0.47	0.52	0.55	0.019	0.020	0.022
A1	0.00	0.03	0.05	0.000	0.001	0.002
b1	0.45	0.50	0.55	0.018	0.020	0.022
b2	0.10	0.15	0.20	0.004	0.006	0.008
D	0.95	1.00	1.05	0.037	0.039	0.041
E	0.55	0.60	0.65	0.022	0.024	0.026
e	---	0.35	---	---	0.014	---
e1	---	0.40	---	---	0.016	---
L	0.20	0.25	0.30	0.008	0.010	0.012
L1	---	0.05	---	---	0.002	---
aaa	0.15			0.006		
bbb	0.05			0.002		

NOTE

1. ALL DIMENSION ARE IN MILLIMETERS.ANGLES ARE IN DEGREES.
2. COPLANARITY APPLIES TO THE EXPOSED HEAT SINK SLUG AS WELL AS THE TERMINALS.

Tape and Reel Dimensions, DFN1.0x0.6

Carrier Tape

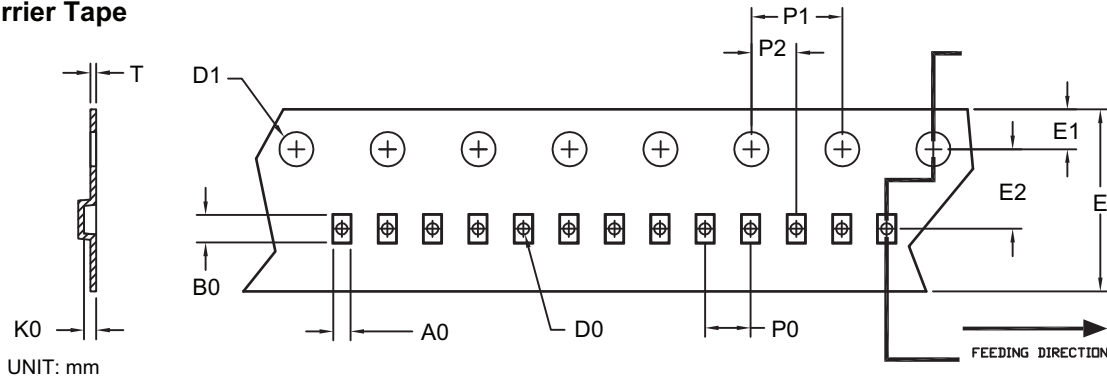

Option	Package	A0	B0	K0	D0	D1	E	E1	E2	P0	P1	P2	T
A	DFN 1.0x0.6/ DFN 1.0x0.6A (8 mm)	0.69 ±0.05	1.19 ±0.05	0.66 ±0.05	0.40 ±0.05	1.50 ±0.10	8.00 +0.3/-0.1	1.75 ±0.10	3.50 ±0.05	2.00 ±0.05	4.00 ±0.10	2.00 ±0.05	0.23 ±0.02
B	DFN 1.0x0.6/ DFN 1.0x0.6A (8 mm)	0.65 ±0.04	1.05 ±0.04	0.61 ±0.04	0.40 ±0.05	1.50 ±0.10	8.00 +0.3/-0.1	1.75 ±0.10	3.50 ±0.05	2.00 ±0.10	4.00 ±0.10	2.00 ±0.05	0.20 ±0.05

Reel

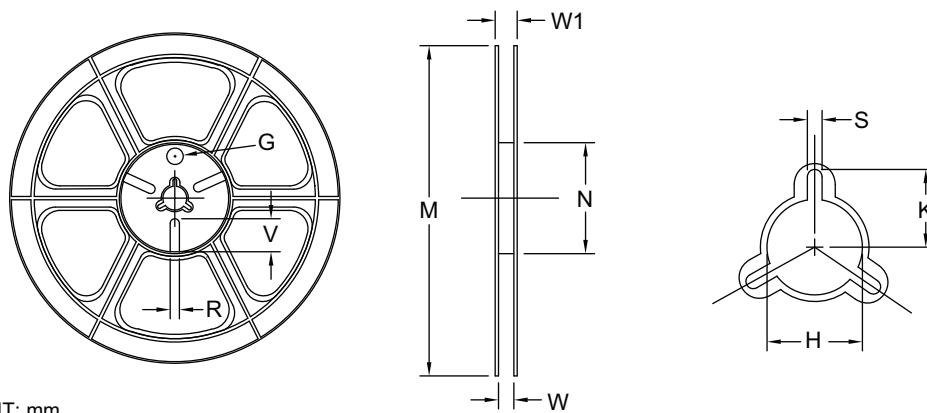

Tape Size	Reel Size	M	N	W	W1	H	K	S	G	R	V
8mm	ø178	ø178 ±0.5	ø55 ±1	8.4 +1.5/-0	Max. 14.4	ø13.0 ±0.5	Max. 10.1	2.0 ±0.5	N/A	N/A	N/A

Leader / Trailer & Orientation

TVS
Unit Per Reel:
10000pcs

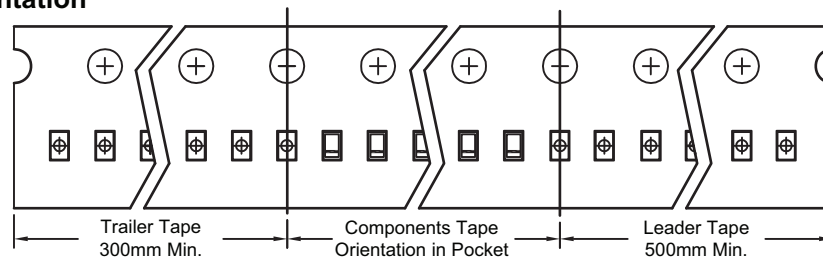

Part Marking

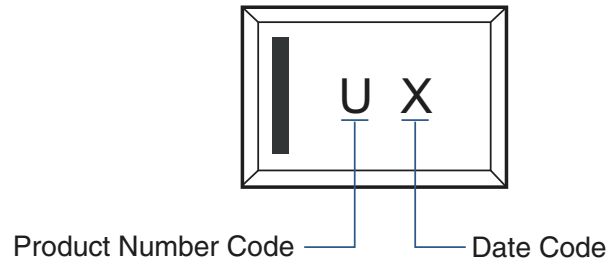

LEGAL DISCLAIMER

Alpha and Omega Semiconductor makes no representations or warranties with respect to the accuracy or completeness of the information provided herein and takes no liabilities for the consequences of use of such information or any product described herein. Alpha and Omega Semiconductor reserves the right to make changes to such information at any time without further notice. This document does not constitute the grant of any intellectual property rights or representation of non-infringement of any third party's intellectual property rights.

LIFE SUPPORT POLICY

ALPHA AND OMEGA SEMICONDUCTOR PRODUCTS ARE NOT AUTHORIZED FOR USE AS CRITICAL COMPONENTS IN LIFE SUPPORT DEVICES OR SYSTEMS.

As used herein:

1. Life support devices or systems are devices or systems which, (a) are intended for surgical implant into the body or (b) support or sustain life, and (c) whose failure to perform when properly used in accordance with instructions for use provided in the labeling, can be reasonably expected to result in a significant injury of the user.
2. A critical component in any component of a life support, device, or system whose failure to perform can be reasonably expected to cause the failure of the life support device or system, or to affect its safety or effectiveness.