

# RF Driver Amplifier

## 250 - 4000 MHz



MAAM-009560

Rev. V2

### Features

- Output Intercept Point of +42 dBm over a 20 dB Input Power Range
- Broadband Operation
- Lead-Free SOT-89 Package
- RoHS\* Compliant
- Class 2 ESD Rating

### Applications

- ISM
- Wireless Networking & Communication

### Description

The MAAM-009560 RF driver amplifier is a GaAs MMIC which exhibits exceptional linearity performance over a >20 dB dynamic range, as well as featuring high gain in a lead-free miniature SOT-89 surface mount plastic package. The device is biased with a single +5 volt supply and consumes 225 mA typically.

The MAAM-009560 is fabricated using an HBT process to realize low current and high linearity. The process features full passivation for increased performance and reliability.

### Functional Schematic

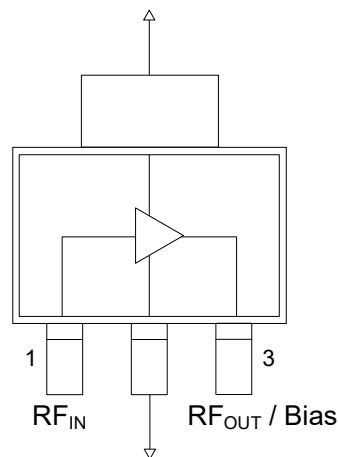

### Pin Configuration

Pin #	Function
1	RF Input
2	Ground
3	RF Output/Bias

### Ordering Information<sup>1,2</sup>

Part Number	Package
MAAM-009560-000000	Bulk Packaging
MAAM-009560-TR1000	1000 piece reel
MAAM-009560-TR3000	3000 piece reel
MAAM-009560-001SMB	Sample Board

1. Reference Application Note M513 for reel size information.
2. All sample boards include 5 loose parts.

\* Restrictions on Hazardous Substances, compliant to current RoHS EU directive.

**Electrical Specifications: Freq. = 2140 MHz, T<sub>A</sub> = 25°C, V<sub>CC</sub> = +5 V, Z<sub>0</sub> = 50 Ω**

Parameter	Units	Min.	Typ.	Max.
Gain	dB	14	15	—
Noise Figure	dB	—	3	—
Input Return Loss	dB	—	15	—
Output Return Loss	dB	—	17	—
Output P1dB	dBm	—	28.5	—
Output IP3	dBm	40	42	—
Quiescent Current	mA	—	220	—
Current (P <sub>IN</sub> = 0 dBm)	mA	—	225	325

**Maximum Operating Conditions<sup>3</sup>**

Parameter	Maximum Operating Conditions
Junction Temperature <sup>4</sup>	170 °C
RF Output Power	28 dBm
Operating Temperature	-40 °C to +85 °C

3. These operating conditions will ensure MTTF > 1 x 10<sup>6</sup> hours.
4. Junction Temperature (T<sub>J</sub>) = T<sub>A</sub> + Θ<sub>Jc</sub> \* ((V \* I) - (P<sub>OUT</sub> - P<sub>IN</sub>))  
 Typical thermal resistance (Θ<sub>Jc</sub>) = 47° C/W
  - a) For T<sub>A</sub> = 25°C,  
 T<sub>J</sub> = 73 °C @ 5 V, 225 mA, P<sub>OUT</sub> = 20 dBm, P<sub>IN</sub> = 5.0 dBm
  - b) For T<sub>A</sub> = 85°C,  
 T<sub>J</sub> = 123 °C @ 5 V, 180 mA, P<sub>OUT</sub> = 20 dBm, P<sub>IN</sub> = 5.5 dBm

**Absolute Maximum Ratings<sup>5,6</sup>**

Parameter	Absolute Maximum
RF Output Power	29 dBm
Voltage	6 volts
Storage Temperature	-65 °C to +150 °C
Junction Temperature	210 °C

5. Exceeding any one or combination of these limits may cause permanent damage to this device.
6. MACOM does not recommend sustained operation near these survivability limits.

### 2140 MHz PCB Layout

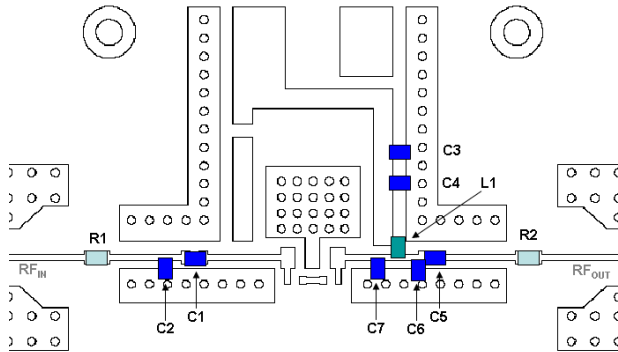

### Parts List

Part	Value	Case Style
C1	1.8 pF	0402
C2	2.2 pF	0402
C3	0.1 $\mu$ F	0402
C4	1000 pF	0402
C5	39 pF	0402
C6	1 pF	0402
C7	2 pF	0402
L1	3.6 nH	0402
R1, R2	0 $\Omega$	0402

### 2140 Schematic

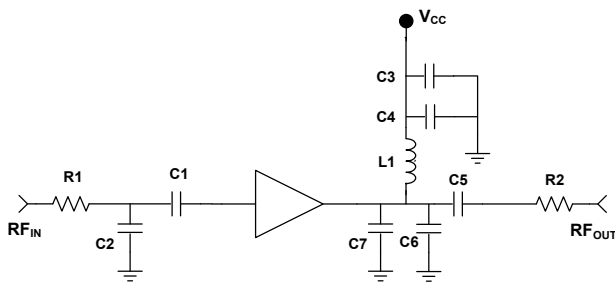

### Cross Section View

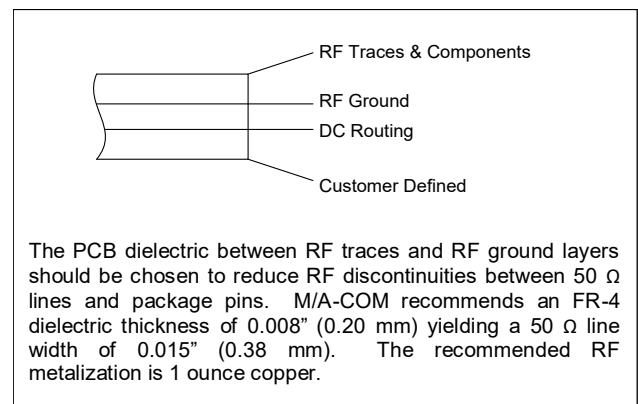

**Typical Performance Curves, 2140 MHz Configuration**

**Gain**

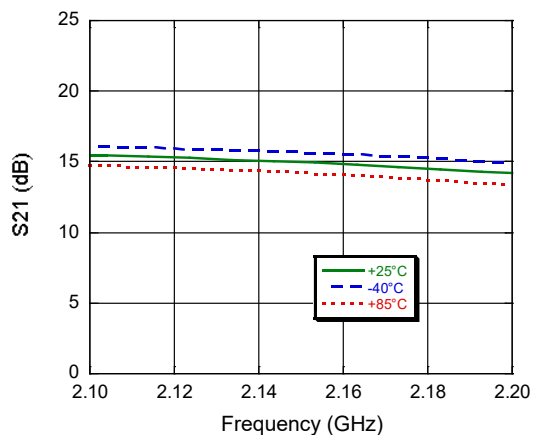

**Input Return Loss**

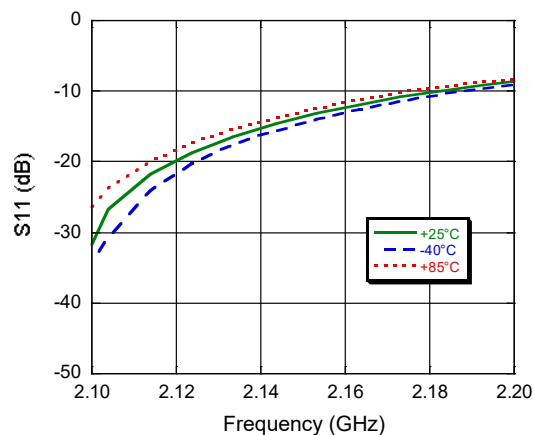

**Output Return Loss**

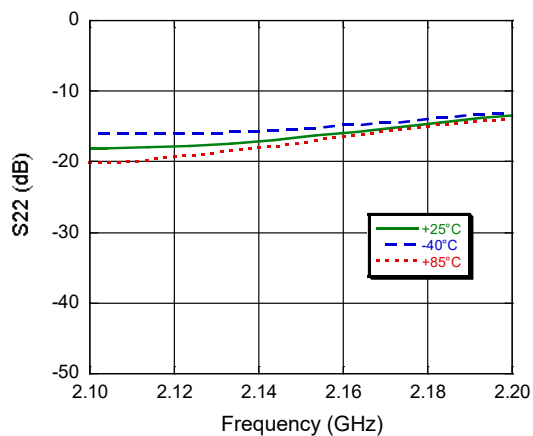

**Noise Figure**

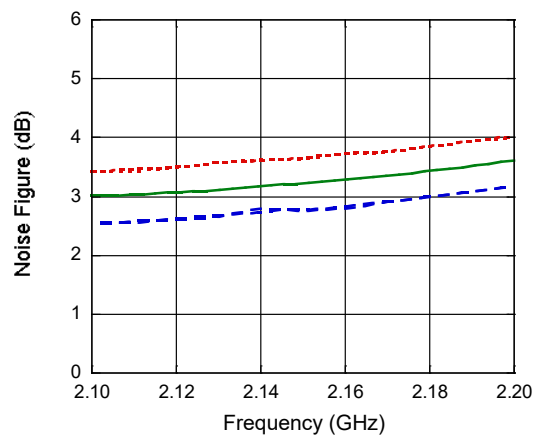

**P1dB**

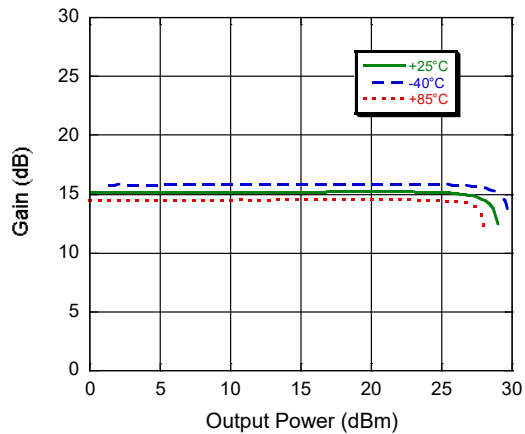

**Output IP3**

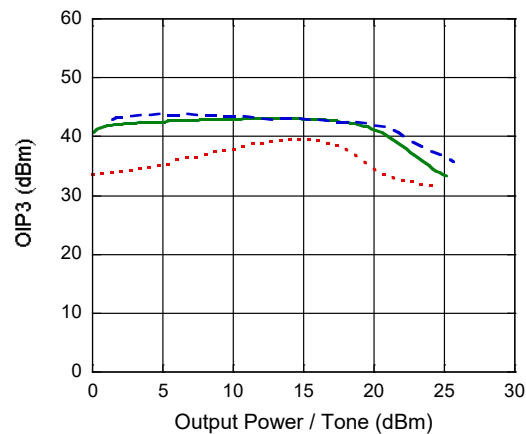

**Typical Performance Curves, 2140 MHz Configuration**

**Current**

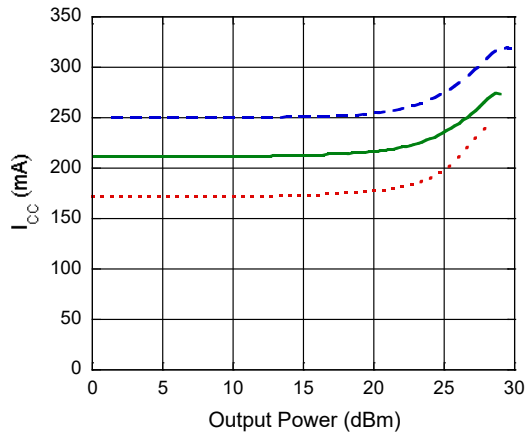

**Handling Procedures**

Please observe the following precautions to avoid damage:

**Static Sensitivity**

Gallium Arsenide Integrated Circuits are sensitive to electrostatic discharge (ESD) and can be damaged by static electricity. Proper ESD control techniques should be used when handling these class 2 devices.

**Lead-Free SOT-89 Plastic Package<sup>†</sup>**

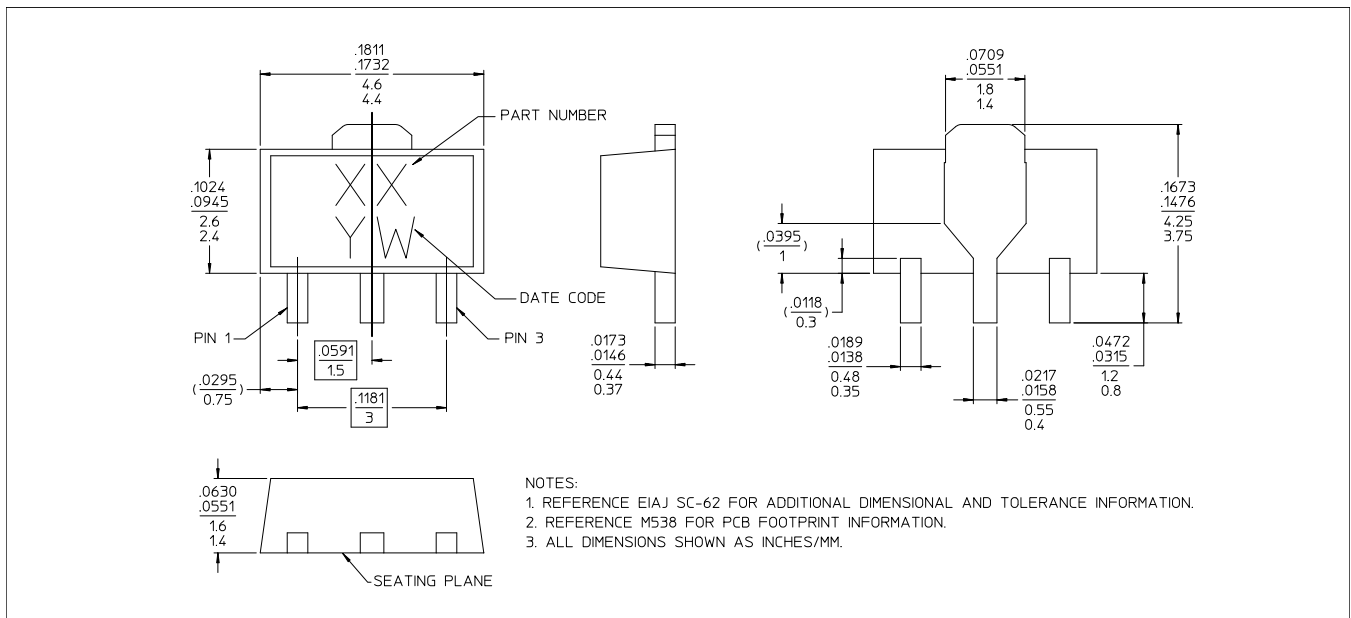

<sup>†</sup> Reference Application Note M538 for lead-free solder reflow recommendations.  
 Meets JEDEC moisture sensitivity level 1 requirements.  
 Plating is 100% matte tin over copper.

MACOM Technology Solutions Inc. ("MACOM"). All rights reserved.

These materials are provided in connection with MACOM's products as a service to its customers and may be used for informational purposes only. Except as provided in its Terms and Conditions of Sale or any separate agreement, MACOM assumes no liability or responsibility whatsoever, including for (i) errors or omissions in these materials; (ii) failure to update these materials; or (iii) conflicts or incompatibilities arising from future changes to specifications and product descriptions, which MACOM may make at any time, without notice. These materials grant no license, express or implied, to any intellectual property rights.

THESE MATERIALS ARE PROVIDED "AS IS" WITH NO WARRANTY OR LIABILITY, EXPRESS OR IMPLIED, RELATING TO SALE AND/OR USE OF MACOM PRODUCTS INCLUDING FITNESS FOR A PARTICULAR PURPOSE, MERCHANTABILITY, INFRINGEMENT OF INTELLECTUAL PROPERTY RIGHT, ACCURACY OR COMPLETENESS, OR SPECIAL, INDIRECT, INCIDENTAL, OR CONSEQUENTIAL DAMAGES WHICH MAY RESULT FROM USE OF THESE MATERIALS.

MACOM products are not intended for use in medical, lifesaving or life sustaining applications. MACOM customers using or selling MACOM products for use in such applications do so at their own risk and agree to fully indemnify MACOM for any damages resulting from such improper use or sale.