

**General Description**

The AO4466 uses advanced trench technology to provide excellent  $R_{DS(ON)}$  and low gate charge. This device is suitable for use as a load switch or in PWM applications. The source leads are separated to allow a Kelvin connection to the source, which may be used to bypass the source inductance.

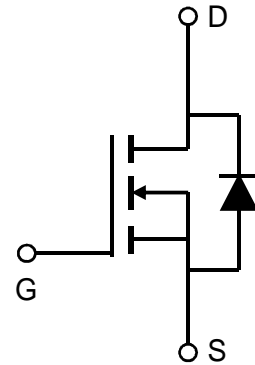

**Product Summary**

$V_{DS}$  (V) = 30V  
 $I_D = 10A$   
 $R_{DS(ON)} < 18m\Omega$  ( $V_{GS} = 10V$ )  
 $R_{DS(ON)} < 25m\Omega$  ( $V_{GS} = 4.5V$ )

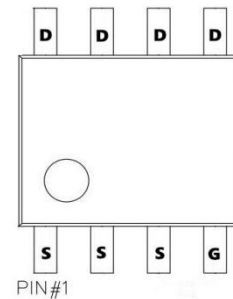

**Absolute Maximum Ratings  $T_A=25^\circ C$  unless otherwise noted**

Parameter	Symbol	Maximum	Units
Drain-Source Voltage	$V_{DS}$	30	V
Gate-Source Voltage	$V_{GS}$	$\pm 20$	V
Continuous Drain Current <sup>AF</sup>	$I_D$	$T_A=25^\circ C$	A
		$T_A=70^\circ C$	
Pulsed Drain Current <sup>B</sup>	$I_{DM}$	64	
Power Dissipation	$P_D$	$T_A=25^\circ C$	W
		$T_A=70^\circ C$	
Avalanche Current <sup>B, G</sup>	$I_{AR}$	12	A
Repetitive avalanche energy 0.1mH <sup>B, G</sup>	$E_{AR}$	7	mJ
Junction and Storage Temperature Range	$T_J, T_{STG}$	-55 to 150	$^\circ C$

Thermal Characteristics					
Parameter		Symbol	Typ	Max	Units
Maximum Junction-to-Ambient <sup>A</sup>	$t \leq 10s$	$R_{\theta JA}$	36	40	$^\circ C/W$
Maximum Junction-to-Ambient <sup>A</sup>	Steady-State		62	75	$^\circ C/W$
Maximum Junction-to-Lead <sup>C</sup>	Steady-State	$R_{\theta JL}$	18	24	$^\circ C/W$

**Electrical Characteristics (T<sub>J</sub>=25°C unless otherwise noted)**

Symbol	Parameter	Conditions	Min	Typ	Max	Units
BV <sub>DSS</sub>	Drain-Source Breakdown Voltage	I <sub>D</sub> =250μA, V <sub>GS</sub> =0V	30			V
I <sub>DSS</sub>	Zero Gate Voltage Drain Current	V <sub>DS</sub> =30 V <sub>GS</sub> =0V T <sub>J</sub> =55°C			1	μA
					5	
I <sub>GSS</sub>	Gate-Body leakage current	V <sub>DS</sub> =0V, V <sub>GS</sub> = ±20V			100	nA
V <sub>GS(th)</sub>	Gate Threshold Voltage	V <sub>DS</sub> =V <sub>GS</sub> I <sub>D</sub> =250μA	1	1.5	2.5	V
I <sub>D(ON)</sub>	On state drain current	V <sub>GS</sub> =4.5V, V <sub>DS</sub> =5V	64			A
R <sub>DS(ON)</sub>	Static Drain-Source On-Resistance	V <sub>GS</sub> =10V, I <sub>D</sub> =10A		13	18	mΩ
		V <sub>GS</sub> =4.5V, I <sub>D</sub> =5A		19	25	mΩ
g <sub>FS</sub>	Forward Transconductance	V <sub>DS</sub> =5V, I <sub>D</sub> =3A		17		S
V <sub>SD</sub>	Diode Forward Voltage	I <sub>S</sub> =1A, V <sub>GS</sub> =0V		0.75	1	V
I <sub>S</sub>	Maximum Body-Diode Continuous Current				2.4	A
C <sub>ISS</sub>	Input Capacitance	V <sub>GS</sub> =0V, V <sub>DS</sub> =15V, f=1MHz	298	373	448	pF
C <sub>OSS</sub>	Output Capacitance		46	67	88	pF
C <sub>rSS</sub>	Reverse Transfer Capacitance		24	41	58	pF
R <sub>g</sub>	Gate resistance	V <sub>GS</sub> =0V, V <sub>DS</sub> =0V, f=1MHz	0.6	1.8	2.8	Ω
Q <sub>g(10V)</sub>	Total Gate Charge	V <sub>GS</sub> =10V, V <sub>DS</sub> =15V, I <sub>D</sub> =10A	5.7	7.1	8.6	nC
Q <sub>g(4.5V)</sub>	Total Gate Charge		2.7	3.5	4.2	nC
Q <sub>gs</sub>	Gate Source Charge			1.2		nC
Q <sub>gd</sub>	Gate Drain Charge			1.6		nC
t <sub>D(on)</sub>	Turn-On DelayTime	V <sub>GS</sub> =10V, V <sub>DS</sub> =15V, R <sub>L</sub> =1.5Ω, R <sub>GEN</sub> =3Ω		4.3		ns
t <sub>r</sub>	Turn-On Rise Time			2.8		ns
t <sub>D(off)</sub>	Turn-Off DelayTime			15.8		ns
t <sub>f</sub>	Turn-Off Fall Time			3		ns
t <sub>rr</sub>	Body Diode Reverse Recovery Time	I <sub>F</sub> =10A, dI/dt=100A/μs	8.4	10.5	12.6	ns
Q <sub>rr</sub>	Body Diode Reverse Recovery Charge	I <sub>F</sub> =10A, dI/dt=100A/μs	3.6	4.5	5.4	nC
t <sub>rr</sub>	Body Diode Reverse Recovery Time	I <sub>F</sub> =10A, dI/dt=500A/μs	4.7	6.0	7.2	ns
Q <sub>rr</sub>	Body Diode Reverse Recovery Charge	I <sub>F</sub> =10A, dI/dt=500A/μs	5.3	6.6	8	nC

A: The value of R<sub>θJA</sub> is measured with the device mounted on 1 in 2 FR-4 board with 2oz. Copper, in a still air environment with T<sub>A</sub>=25° C. The value in any given application depends on the user's specific board design.

B: Repetitive rating, pulse width limited by junction temperature.

C: The R<sub>θJA</sub> is the sum of the thermal impedance from junction to lead R<sub>θJL</sub> and lead to ambient.

D: The static characteristics in Figures 1 to 6 are obtained using <300 μs pulses, duty cycle 0.5% max.

E: These tests are performed with the device mounted on 1 in 2 FR-4 board with 2oz. Copper, in a still air environment with T<sub>A</sub>=25° C. The SOA curve provides a single pulse rating.

F: The current rating is based on the t ≤ 10s junction to ambient thermal resistance rating.

G: L=100uH, V<sub>DD</sub>=0V, R<sub>G</sub>=0Ω, rated V<sub>DS</sub>=30V and V<sub>GS</sub>=10V

TYPICAL ELECTRICAL AND THERMAL CHARACTERISTICS

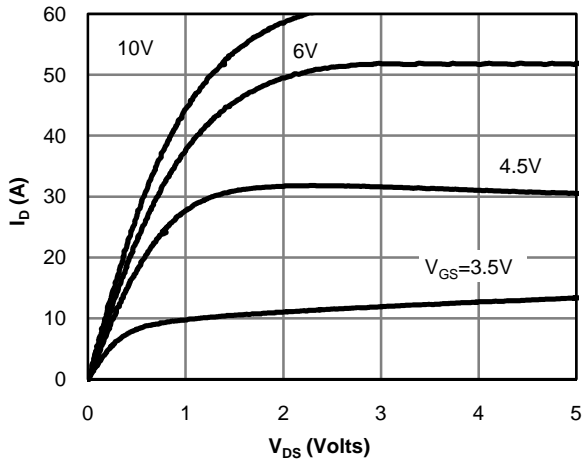

Fig 1: On-Region Characteristics

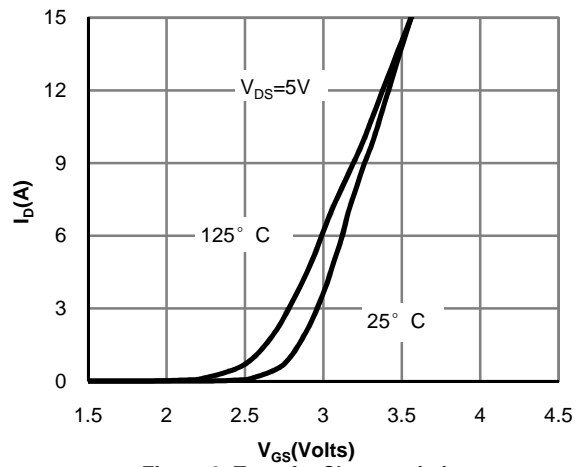

Figure 2: Transfer Characteristics

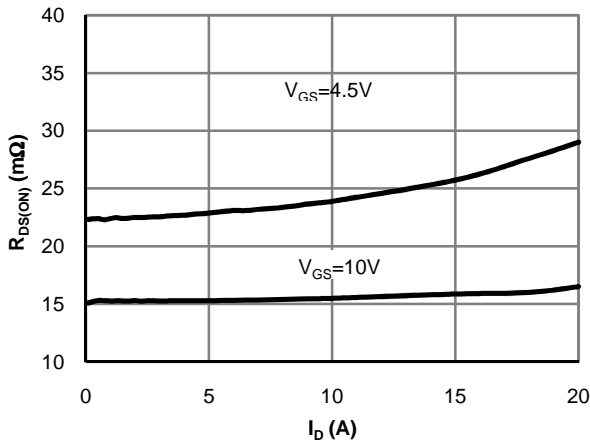

Figure 3: On-Resistance vs. Drain Current and Gate Voltage

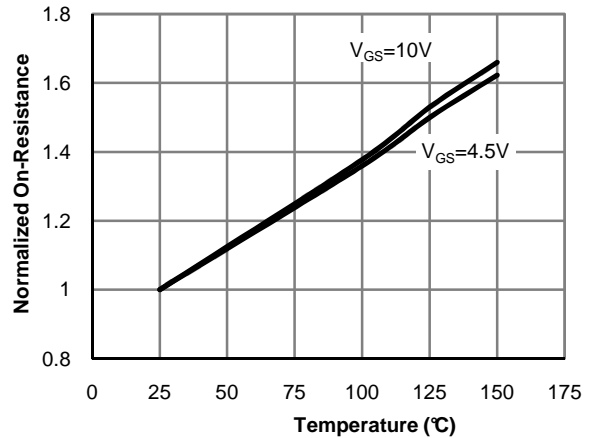

Figure 4: On-Resistance vs. Junction Temperature

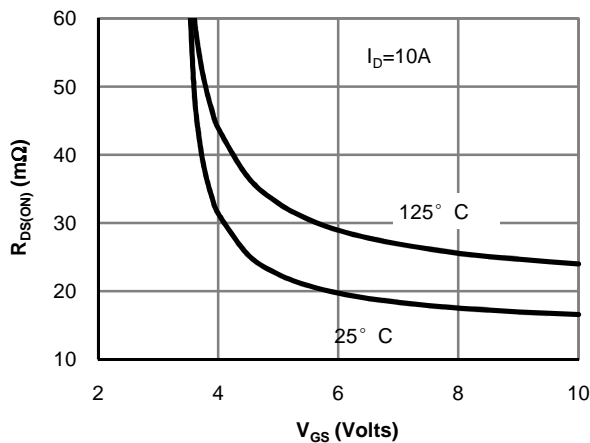

Figure 5: On-Resistance vs. Gate-Source Voltage

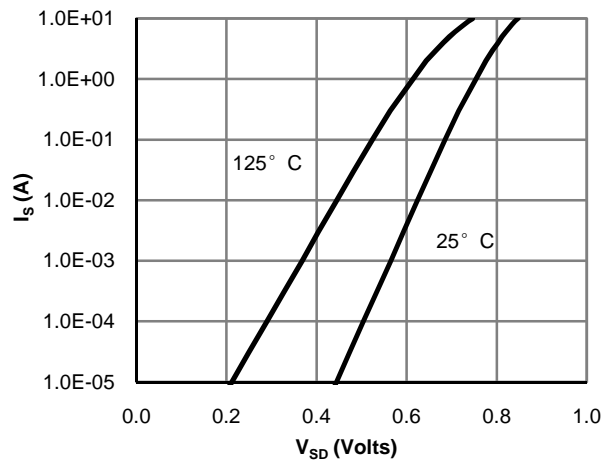

Figure 6: Body-Diode Characteristics

TYPICAL ELECTRICAL AND THERMAL CHARACTERISTICS

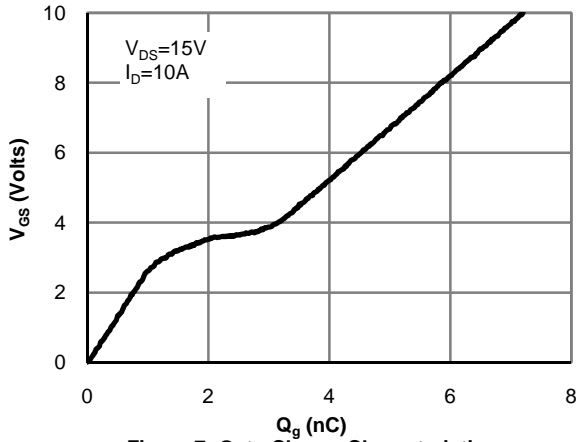

Figure 7: Gate-Charge Characteristics

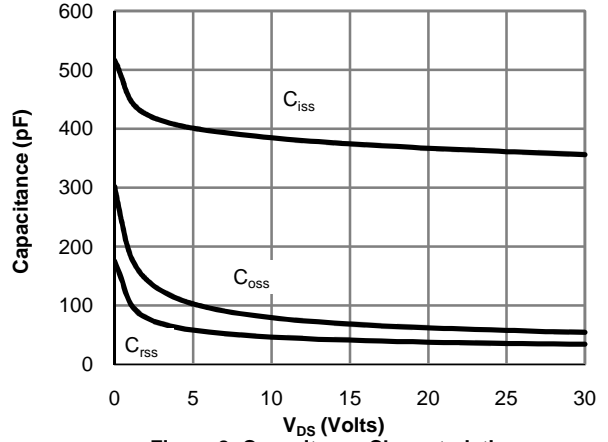

Figure 8: Capacitance Characteristics

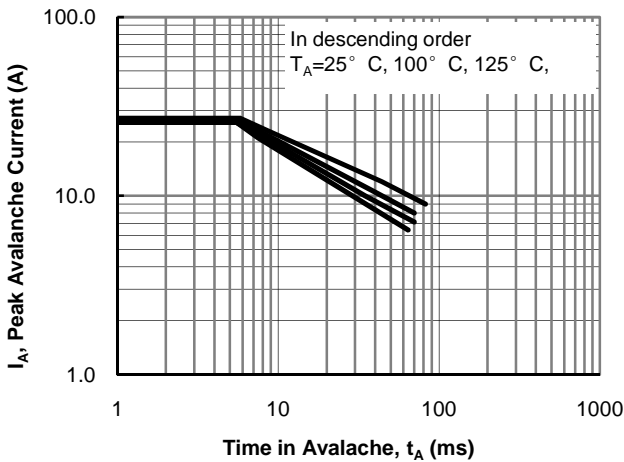

Figure 9: Single Pulse Avalanche Capability

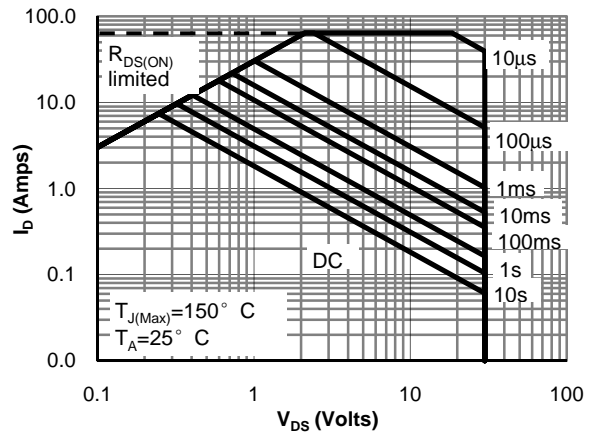

Figure 10: Maximum Forward Biased Safe Operating Area (Note E)

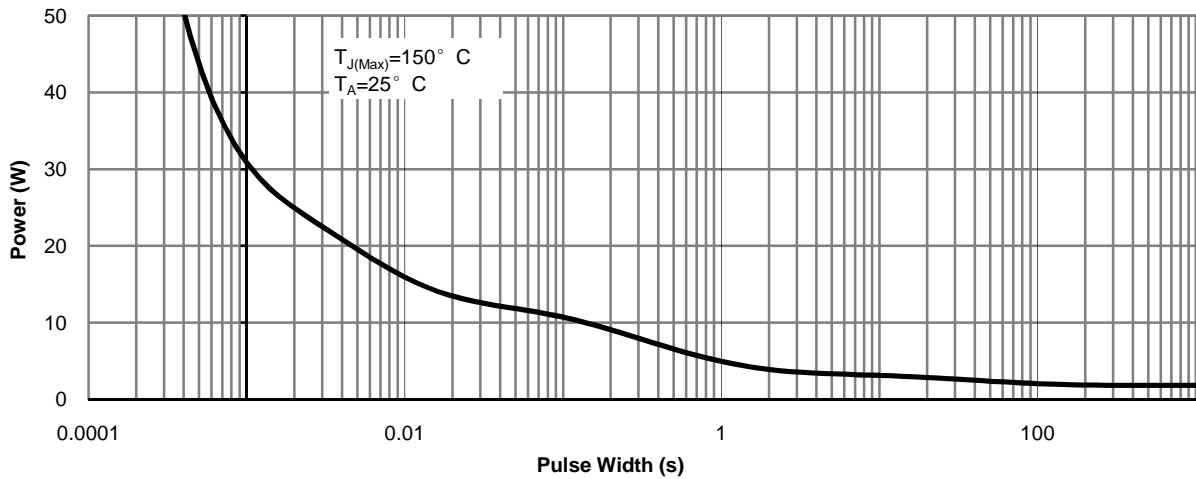
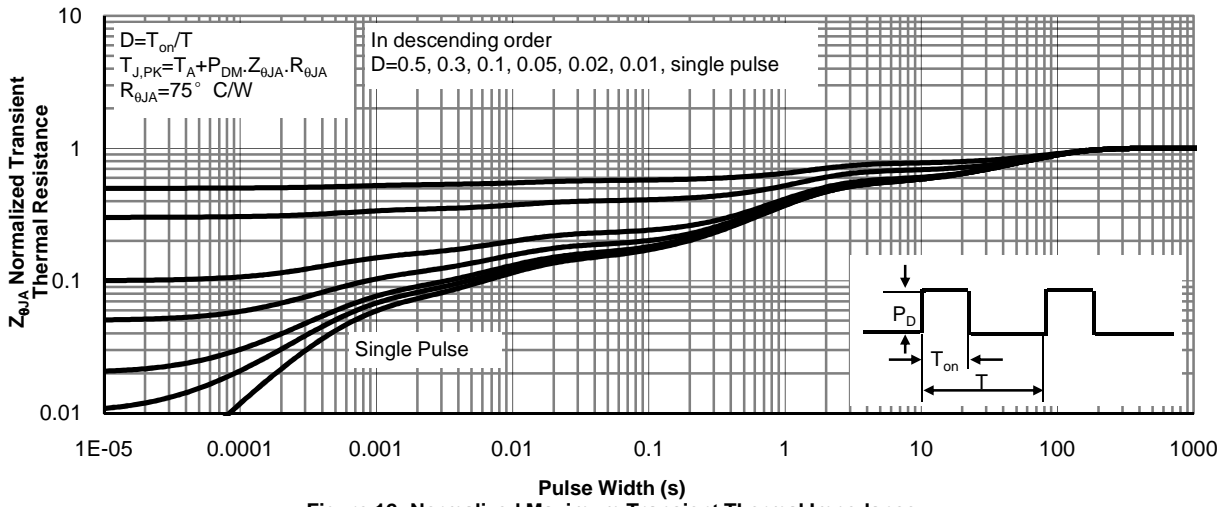
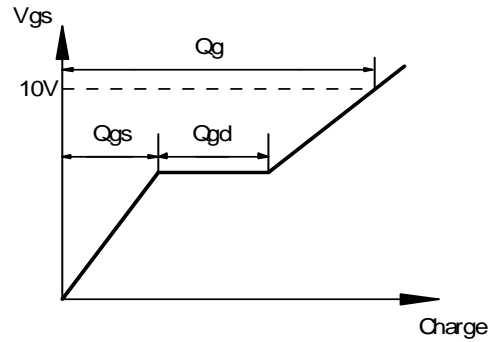
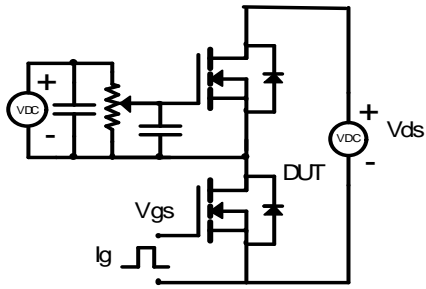

Figure 11: Single Pulse Power Rating Junction-to-Ambient (Note E)

TYPICAL ELECTRICAL AND THERMAL CHARACTERISTICS



Gate Charge Test Circuit & Waveform



Resistive Switching Test Circuit & Waveforms

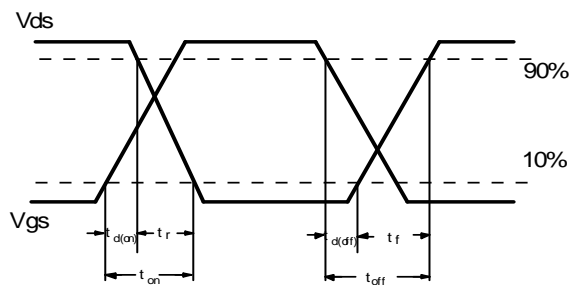
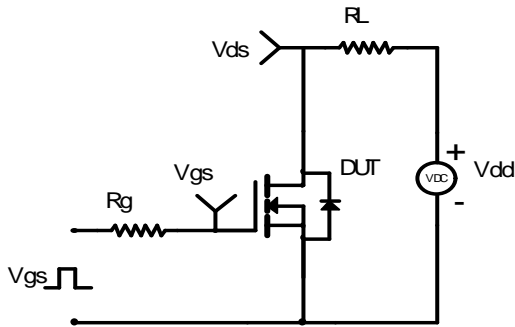

Unclamped Inductive Switching (UIS) Test Circuit &

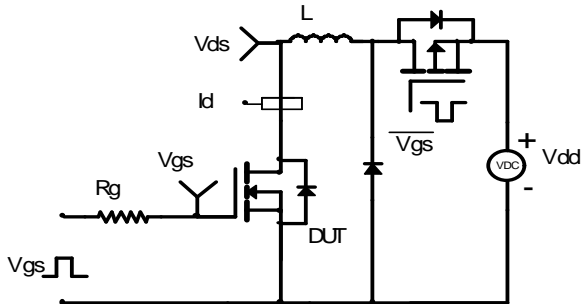

Waveforms

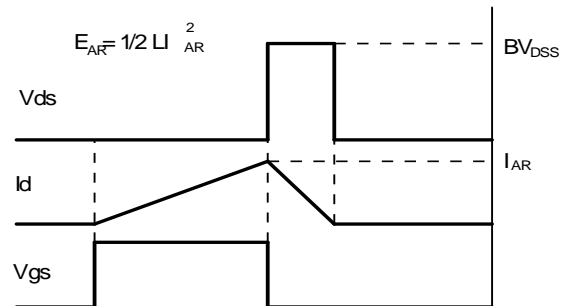

Diode Recovery Test Circuit & Waveforms

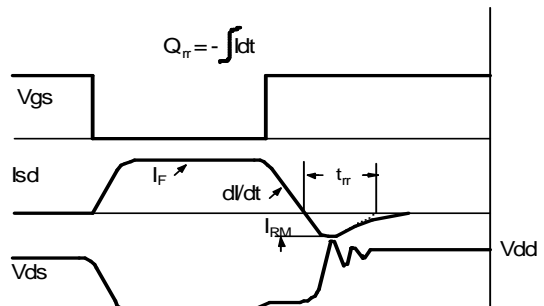
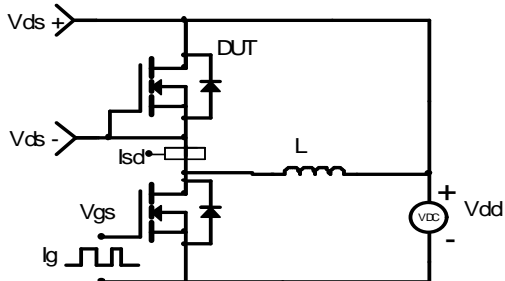

PACKAGE OUTLINE DIMENSIONS

SOP-8

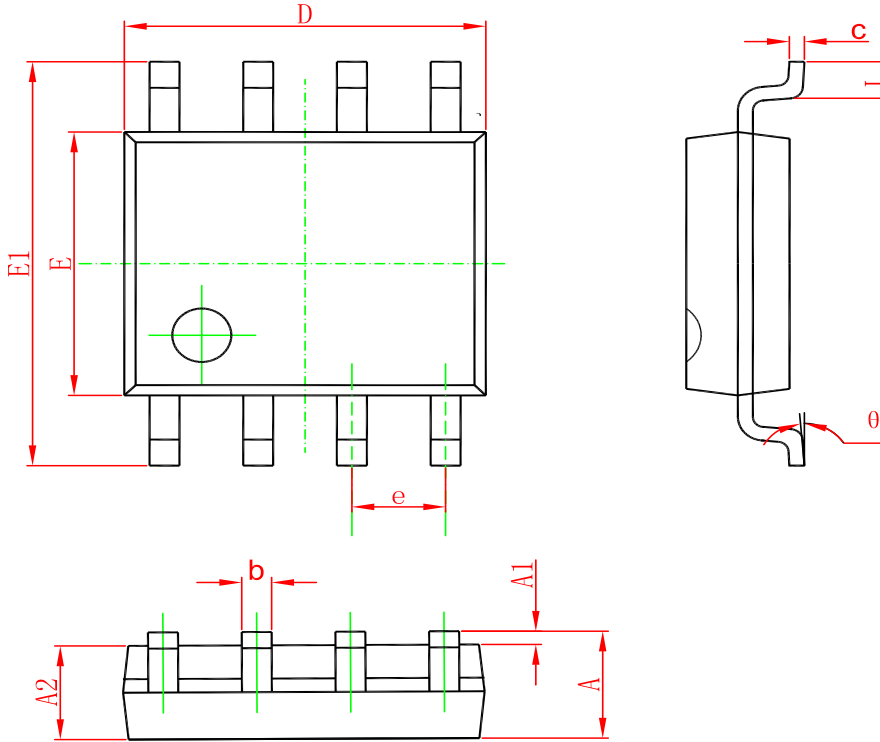

Symbol	Dimensions In Millimeters		Dimensions In Inches	
	Min	Max	Min	Max
A	1.350	1.750	0.053	0.069
A1	0.100	0.250	0.004	0.010
A2	1.350	1.550	0.053	0.061
b	0.330	0.510	0.013	0.020
c	0.170	0.250	0.006	0.010
D	4.700	5.100	0.185	0.200
E	3.800	4.000	0.150	0.157
E1	5.800	6.200	0.228	0.244
e	1.270(BSC)		0.050(BSC)	
L	0.400	1.270	0.016	0.050
θ	0°	8°	0°	8°

**Marking**

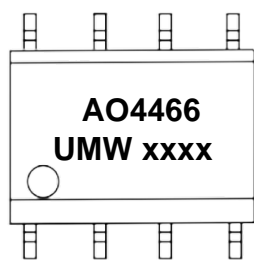

("xxxx"代表年份周期)

**Ordering information**

Order code	Package	Baseqty	Deliverymode
UMW AO4466	SOP-8	3000	Tape and reel