

DRV5057 Linear Hall Effect Sensor With PWM Output

1 Features

- PWM-output linear Hall effect magnetic sensor
- Operates from 3.3-V and 5-V power supplies
- 2-kHz clock output with 50% quiescent duty cycle
- Magnetic sensitivity options (at $V_{CC} = 5\text{ V}$):
 - A1/Z1: 2%D/mT, $\pm 21\text{-mT}$ range
 - A2/Z2: 1%D/mT, $\pm 42\text{-mT}$ range
 - A3/Z3: 0.5%D/mT, $\pm 84\text{-mT}$ range
 - A4/Z4: 0.25%D/mT, $\pm 168\text{-mT}$ range
- Open-drain output with 20-mA sink capability
- Compensation for magnet temperature drift for A1/A2/A3/A4 Versions and None for Z1/Z2/Z3/Z4 Versions
- Industry standard package:
 - Surface-mount SOT-23
 - Through-hole TO-92

2 Applications

- Precise position sensing
- Industrial automation and robotics
- Home appliances
- Gamepads, pedals, keyboards, triggers
- Height leveling, tilt and weight measurement
- Fluid flow rate measurement
- Medical devices
- Absolute angle encoding
- Current sensing

3 Description

The DRV5057 is a linear Hall effect sensor that responds proportionally to magnetic flux density. The device can be used for accurate position sensing in a wide range of applications.

The device operates from 3.3-V or 5-V power supplies. When no magnetic field is present, the output produces a clock with a 50% duty cycle. The output duty cycle changes linearly with the applied magnetic flux density, and four sensitivity options maximize the output dynamic range based on the required sensing range. North and south magnetic poles produce unique outputs. The typical pulse-width modulation (PWM) carrier frequency is 2 kHz.

Magnetic flux perpendicular to the top of the package is sensed, and the two package options provide different sensing directions.

Because the PWM signal is based on edge-to-edge timing, signal integrity is maintained in the presence of voltage noise or ground potential mismatch. This signal is suitable for distance transmission in noisy environments, and the always-present clock allows the system controller to confirm there are good interconnects. Additionally, the device features magnet temperature compensation to counteract how magnets drift for linear performance across a wide – 40°C to +125°C temperature range. Device options for no temperature compensation of magnet drift are also available.

Device Information

PART NUMBER	PACKAGE ⁽¹⁾	BODY SIZE (NOM)
DRV5057	SOT-23 (3)	2.92 mm × 1.30 mm
	TO-92 (3)	4.00 mm × 3.15 mm

(1) For all available packages, see the package option addendum at the end of the data sheet.

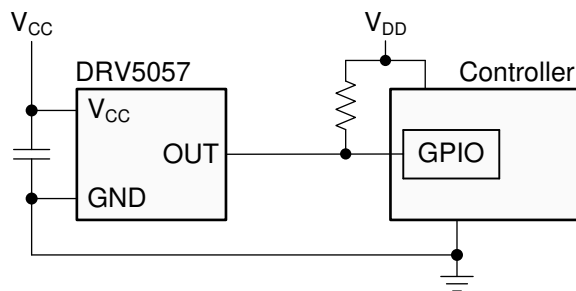

Typical Schematic

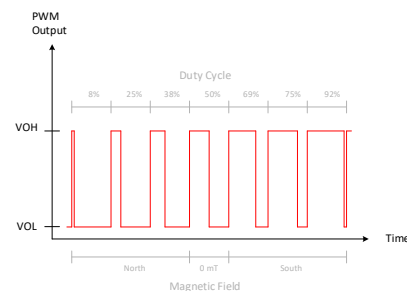

Magnetic Response



Table of Contents

1 Features	1	7.4 Device Functional Modes.....	13
2 Applications	1	8 Application and Implementation	14
3 Description	1	8.1 Application Information.....	14
4 Revision History	2	8.2 Typical Applications.....	15
5 Pin Configuration and Functions	3	8.3 What to Do and What Not to Do.....	22
Pin Functions.....	3	9 Power Supply Recommendations	23
6 Specifications	3	10 Layout	23
6.1 Absolute Maximum Ratings.....	3	10.1 Layout Guidelines.....	23
6.2 ESD Ratings.....	4	10.2 Layout Examples	23
6.3 Recommended Operating Conditions.....	4	11 Device and Documentation Support	24
6.4 Thermal Information.....	4	11.1 Documentation Support.....	24
6.5 Electrical Characteristics.....	4	11.2 Receiving Notification of Documentation Updates..	24
6.6 Magnetic Characteristics.....	4	11.3 Support Resources.....	24
6.7 Typical Characteristics.....	6	11.4 Trademarks.....	24
7 Detailed Description	10	11.5 Electrostatic Discharge Caution.....	24
7.1 Overview.....	10	11.6 Glossary.....	24
7.2 Functional Block Diagram.....	10	12 Mechanical, Packaging, and Orderable Information	24
7.3 Feature Description.....	10		

4 Revision History

Changes from Revision * (November 2018) to Revision A (August 2020)	Page
• Updated the numbering format for tables, figures, and cross-references throughout the document.....	1
• Added Zero TC sensitivity options	1
• Added Zero TC information to Section 6.6	4
• Fixed labels for some of the plots for graphs for DRV5057 A1/A2/A3/A4 devices and added Zero TC characteristics plots for DRV5057 Z1/Z2/Z3/Z4 devices in Section 6.7	6
• Updated Section 7.3.4 section for Zero TC options.....	12

5 Pin Configuration and Functions

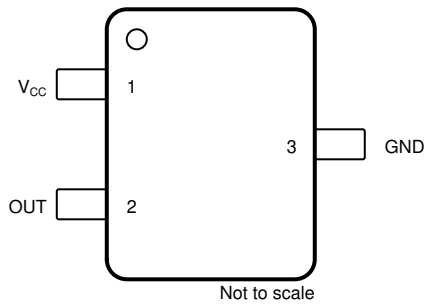

Figure 5-1. DBZ Package 3-Pin SOT-23 Top View

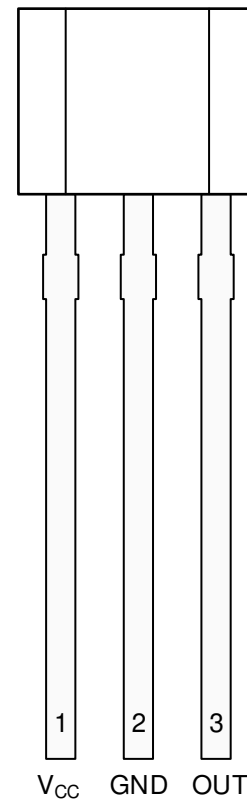

Figure 5-2. LPG Package 3-Pin TO-92 Top View

Pin Functions

NAME	PIN		TYPE	DESCRIPTION
	SOT-23	TO-92		
GND	3	2	Ground	Ground reference
OUT	2	3	Output	Analog output
V _{CC}	1	1	Power	Power supply. Connect this pin to a ceramic capacitor to ground with a value of at least 0.01 μ F.

6 Specifications

6.1 Absolute Maximum Ratings

over operating free-air temperature range (unless otherwise noted)⁽¹⁾

			MIN	MAX	UNIT
V _{CC}	Power supply voltage	V _{CC}	-0.3	7	V
	Output voltage	OUT	-0.3	6	V
	Output current	OUT		30	mA
B	Magnetic flux density		Unlimited		T
T _J	Operating junction temperature		-40	150	°C
T _{stg}	Storage temperature		-65	150	°C

- (1) Stresses beyond those listed under *Absolute Maximum Ratings* may cause permanent damage to the device. These are stress ratings only, which do not imply functional operation of the device at these or any other conditions beyond those indicated under *Recommended Operating Conditions*. Exposure to absolute-maximum-rated conditions for extended periods may affect device reliability.

6.2 ESD Ratings

			VALUE	UNIT
V _(ESD)	Electrostatic discharge	Human-body model (HBM), per ANSI/ESDA/JEDEC JS-001 ⁽¹⁾	±3000	V
		Charged-device model (CDM), per JEDEC specification JESD22-C101 ⁽²⁾	±750	

(1) JEDEC document JEP155 states that 500-V HBM allows safe manufacturing with a standard ESD control process.

(2) JEDEC document JEP157 states that 250-V CDM allows safe manufacturing with a standard ESD control process.

6.3 Recommended Operating Conditions

over operating free-air temperature range (unless otherwise noted)

		MIN	MAX	UNIT
V _{CC}	Power-supply voltage ⁽¹⁾	3	3.63	V
		4.5	5.5	
V _O	Output pullup voltage	0	5.5	V
I _O	Output continuous current	0	20	mA
T _A	Operating ambient temperature ⁽²⁾	−40	125	°C

(1) There are two isolated operating V_{CC} ranges. For more information see the [Section 7.3.3](#) section.

(2) Power dissipation and thermal limits must be observed.

6.4 Thermal Information

THERMAL METRIC ⁽¹⁾		DRV5057		UNIT
		SOT-23 (DBZ)	TO-92 (LPG)	
		3 PINS	3 PINS	
R _{θJA}	Junction-to-ambient thermal resistance	170	121	°C/W
R _{θJC(top)}	Junction-to-case (top) thermal resistance	66	67	°C/W
R _{θJB}	Junction-to-board thermal resistance	49	97	°C/W
Ψ _{JT}	Junction-to-top characterization parameter	1.7	7.6	°C/W
Ψ _{JB}	Junction-to-board characterization parameter	48	97	°C/W

(1) For more information about traditional and new thermal metrics, see the [Semiconductor and IC Package Thermal Metrics application report](#).

6.5 Electrical Characteristics

for V_{CC} = 3 V to 3.63 V and 4.5 V to 5.5 V, over operating free-air temperature range (unless otherwise noted)

PARAMETER		TEST CONDITIONS	MIN	TYP	MAX	UNIT
I _{CC}	Operating supply current			6	10	mA
t _{ON}	Power-on time (see Figure 7-4) ⁽²⁾	B ⁽¹⁾ = 0 mT, no load on OUT		0.6	0.9	ms
f _{PWM}	PWM carrier frequency		1.8	2.0	2.2	kHz
D _J	Duty cycle peak-to-peak jitter	From change in B to change in OUT		±0.1		%D ⁽¹⁾
I _{OZ}	High-impedance output leakage current	V _{CC} = 5 V			100	nA
V _{OL}	Low-level output voltage	I _{OUT} = 20 mA		0.15	0.4	V

(1) This unit is a percentage of duty cycle.

(2) t_{ON} is the time from when V_{CC} goes above 3 V until the first rising edge of the first valid pulse.

6.6 Magnetic Characteristics

for V_{CC} = 3 V to 3.63 V and 4.5 V to 5.5 V, over operating free-air temperature range (unless otherwise noted)

PARAMETER		TEST CONDITIONS	MIN	TYP	MAX	UNIT
D _L	Linear duty cycle range		8		92	%D ⁽¹⁾

for $V_{CC} = 3\text{ V to }3.63\text{ V}$ and $4.5\text{ V to }5.5\text{ V}$, over operating free-air temperature range (unless otherwise noted)

PARAMETER		TEST CONDITIONS	MIN	TYP	MAX	UNIT	
D_{CL}	Clamped-low duty cycle	$B^{(1)} < -250\text{ mT}$	5.3	6	6.7	%D	
D_{CH}	Clamped-high duty cycle	$B > 250\text{ mT}$	93.3	94	94.7		
D_Q	Quiescent duty cycle ⁽²⁾	$B = 0\text{ mT}$, $T_A = 25^\circ\text{C}$, $V_{CC} = 3.3\text{ V or }5\text{ V}$	46	50	54		
$V_{Q\Delta L}$	Quiescent duty cycle lifetime drift	High-temperature operating stress for 1000 hours	< 0.5			%	
S	Sensitivity ⁽⁵⁾	$V_{CC} = 5\text{ V}$, $T_A = 25^\circ\text{C}$	DRV5057A1/Z1	1.88	2	2.12	%D/mT
			DRV5057A2/Z2	0.94	1	1.06	
			DRV5057A3/Z3	0.47	0.5	0.53	
			DRV5057A4/Z4	0.23	0.25	0.27	
		$V_{CC} = 3.3\text{ V}$, $T_A = 25^\circ\text{C}$	DRV5057A1/Z1	1.13	1.2	1.27	
			DRV5057A2/Z2	0.56	0.6	0.64	
			DRV5057A3/Z3	0.28	0.3	0.32	
			DRV5057A4/Z4	0.138	0.15	0.162	
B_L	Linear magnetic flux density sensing range ^{(2) (3) (5)}	$V_{CC} = 5\text{ V}$, $T_A = 25^\circ\text{C}$	DRV5057A1/Z1	± 21		mT	
			DRV5057A2/Z2	± 42			
			DRV5057A3/Z3	± 84			
			DRV5057A4/Z4	± 168			
S_{TC}	Sensitivity temperature compensation for magnets ⁽⁴⁾	DRV5057A1, DRV5057A2, DRV5057A3, DRV5057A4	0.12		%/°C		
S_{TCz}	Sensitivity temperature compensation for magnets ^{(4) (5)}	DRV5057Z1, DRV5057Z2, DRV5057Z3, DRV5057Z4	0		%/°C		
S_{LE}	Sensitivity linearity error ⁽²⁾	Output duty cycle is within D_L	± 1		%		
R_{SE}	Sensitivity error over operating VCC range	Output duty cycle is within D_L	± 1		%		
$S_{\Delta L}$	Quiescent error over operating VCC range		< 0.5		%		

(1) B is the applied magnetic flux density.

 (2) See the [Section 7.3.2](#) section.

 (3) B_L describes the minimum linear sensing range at 25°C taking into account the maximum V_Q and sensitivity tolerances.

 (4) S_{TC} describes the rate the device increases Sensitivity with temperature. For more information, see the [Section 7.3.4](#) section and [Figure 6-7](#) to [Figure 6-20](#).

(5) Product Preview data only for DRV5055Z1 - DRV5055Z4 device options.

6.7 Typical Characteristics

for $T_A = 25^\circ\text{C}$ (unless otherwise noted)

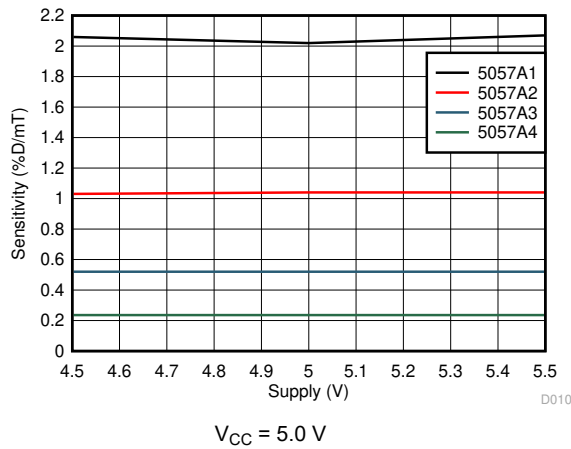

Figure 6-1. Sensitivity vs Supply Voltage

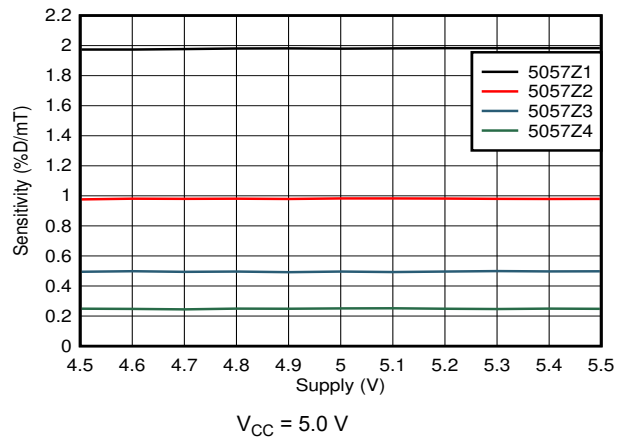

Figure 6-2. Sensitivity vs Supply Voltage

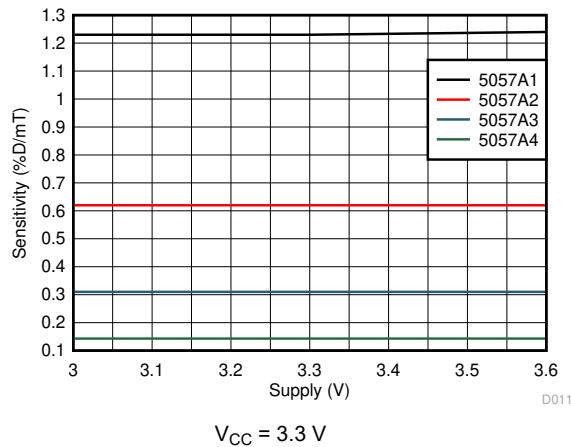

Figure 6-3. Sensitivity vs Supply Voltage

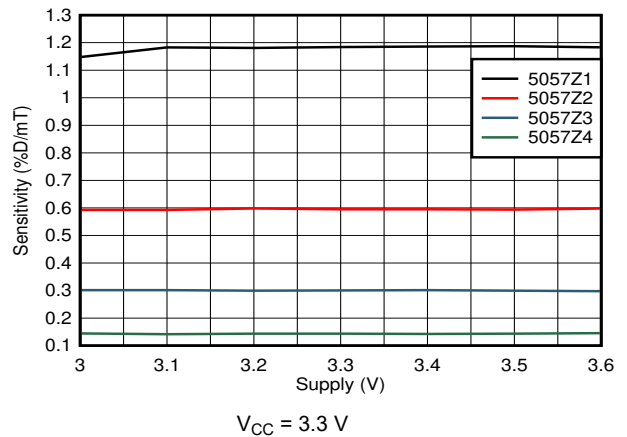

Figure 6-4. Sensitivity vs Supply Voltage

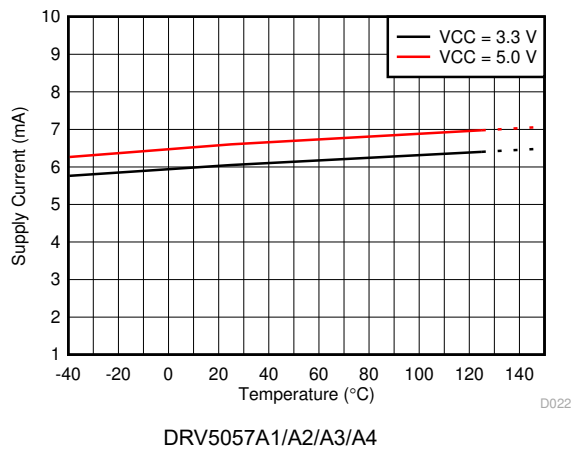

Figure 6-5. Supply Current vs Temperature

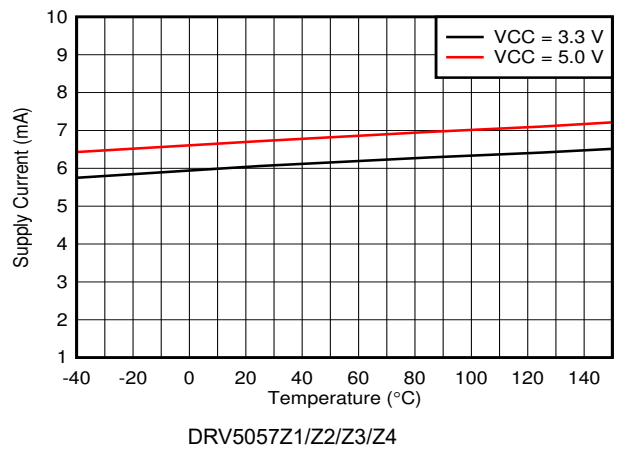
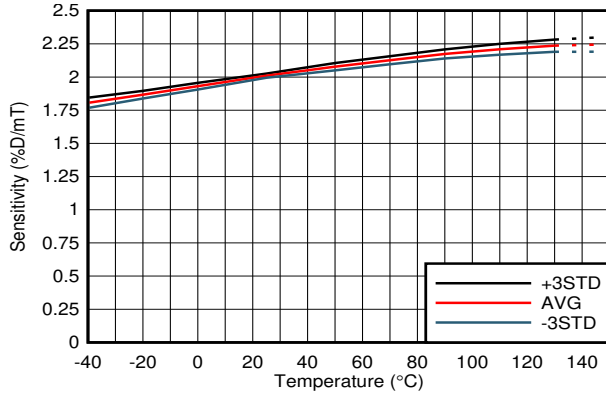
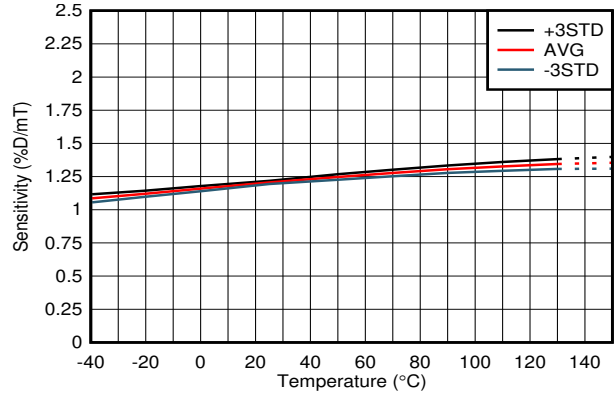

Figure 6-6. Supply Current vs Temperature



DRV5057A1, $V_{CC} = 5.0\text{ V}$

Figure 6-7. Sensitivity vs Temperature



DRV5057A1, $V_{CC} = 3.3\text{ V}$

Figure 6-8. Sensitivity vs Temperature

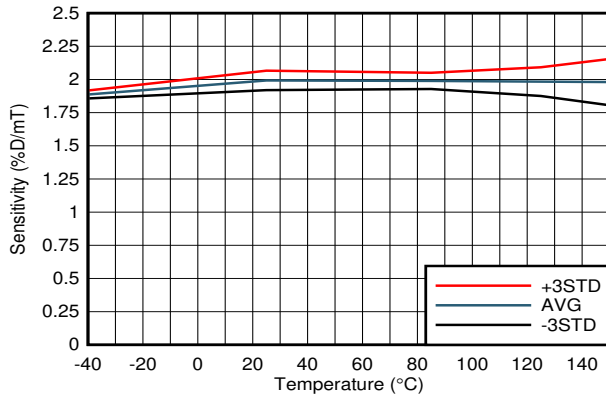

DRV5057Z1, $V_{CC} = 5.0\text{ V}$

Figure 6-9. Sensitivity vs Temperature

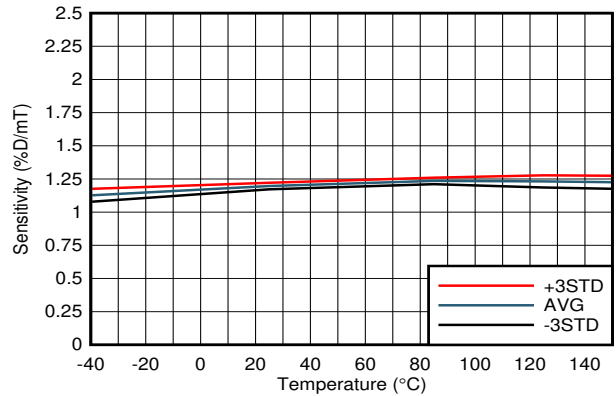

DRV5057Z1, $V_{CC} = 3.3\text{ V}$

Figure 6-10. Sensitivity vs Temperature

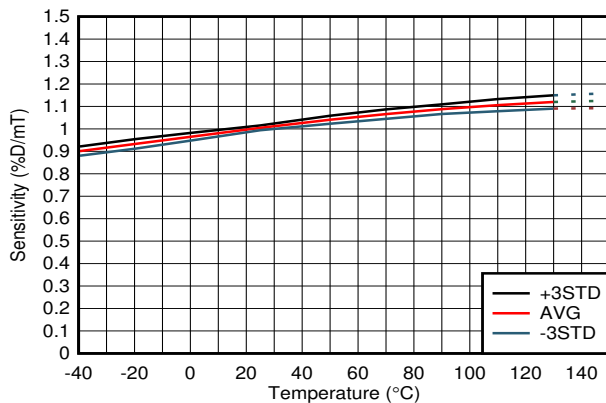

DRV5057A2, $V_{CC} = 5.0\text{ V}$

Figure 6-11. Sensitivity vs Temperature

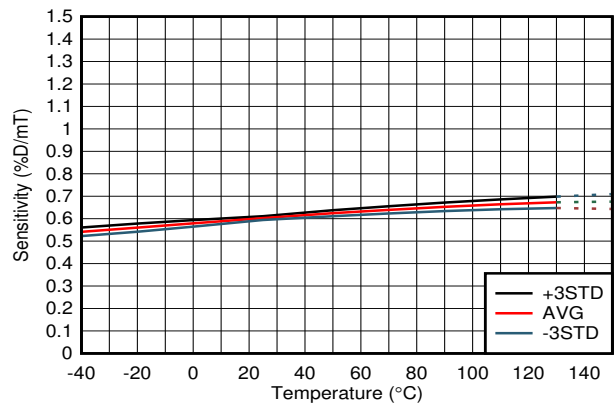

DRV5057A2, $V_{CC} = 3.3\text{ V}$

Figure 6-12. Sensitivity vs Temperature

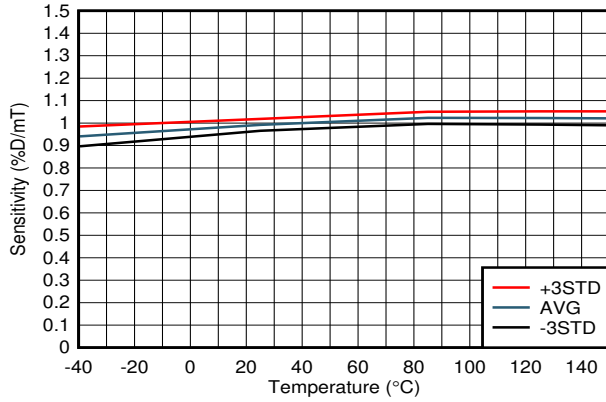

DRV5057Z2, $V_{CC} = 5.0$ V

Figure 6-13. Sensitivity vs Temperature

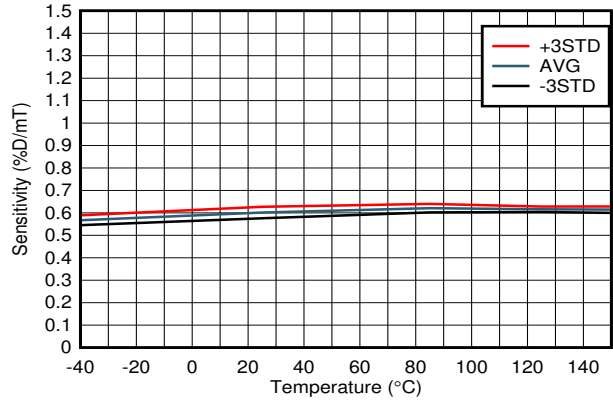

DRV5057Z2, $V_{CC} = 3.3$ V

Figure 6-14. Sensitivity vs Temperature

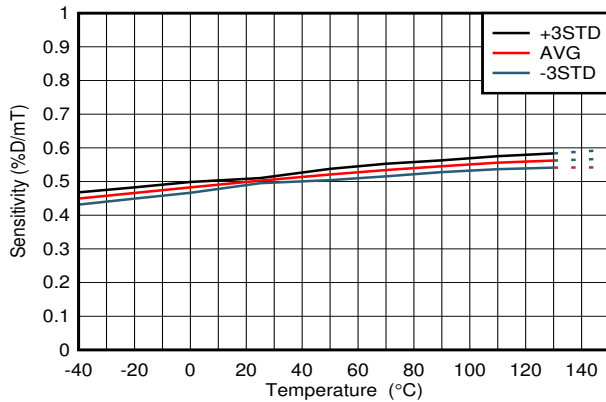

DRV5057A3, $V_{CC} = 5.0$ V

Figure 6-15. Sensitivity vs Temperature

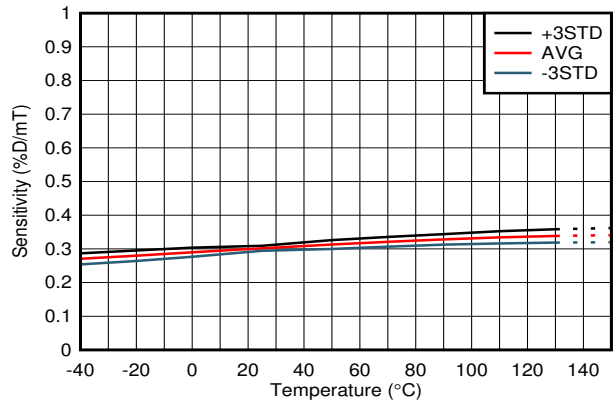

DRV5057A3, $V_{CC} = 3.3$ V

Figure 6-16. Sensitivity vs Temperature

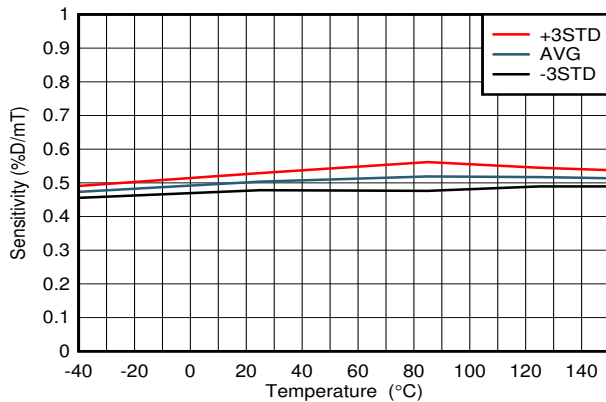

DRV5057Z3, $V_{CC} = 5.0$ V

Figure 6-17. Sensitivity vs Temperature

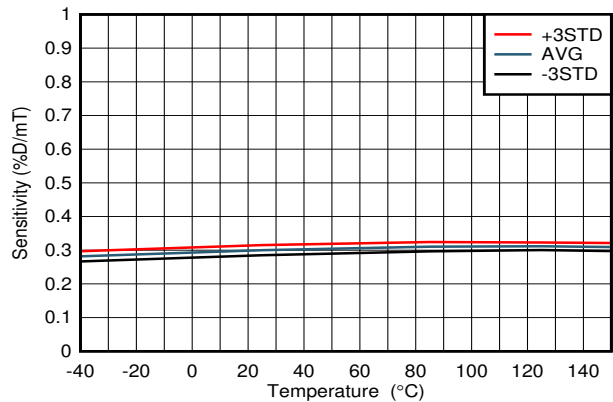

DRV5057Z3, $V_{CC} = 3.3$ V

Figure 6-18. Sensitivity vs Temperature

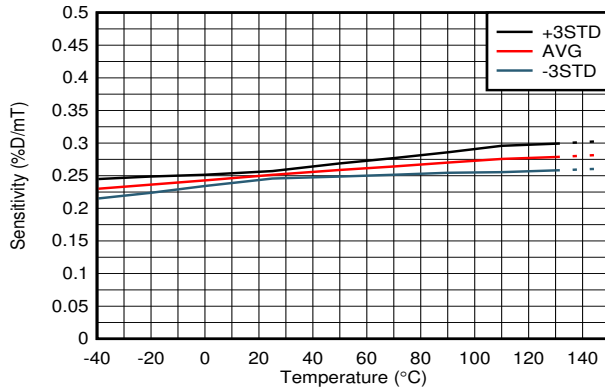

DRV5057A4, $V_{CC} = 5.0\text{ V}$

Figure 6-19. Sensitivity vs Temperature

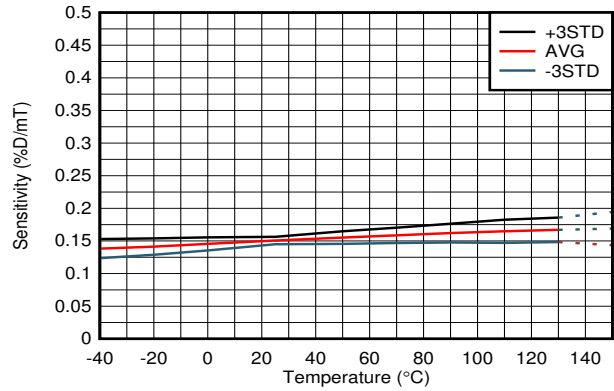

DRV5057A4, $V_{CC} = 3.3\text{ V}$

Figure 6-20. Sensitivity vs Temperature

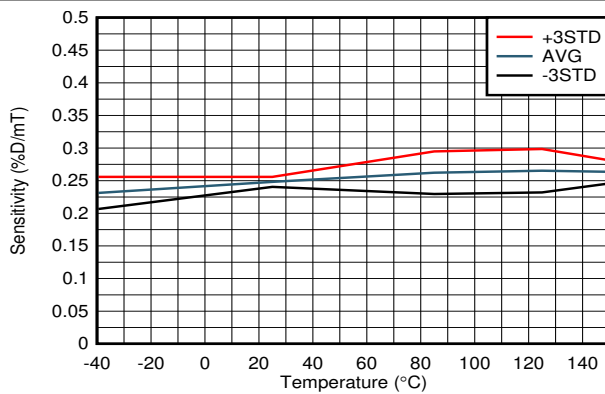

DRV5057Z4, $V_{CC} = 5.0\text{ V}$

Figure 6-21. Sensitivity vs Temperature

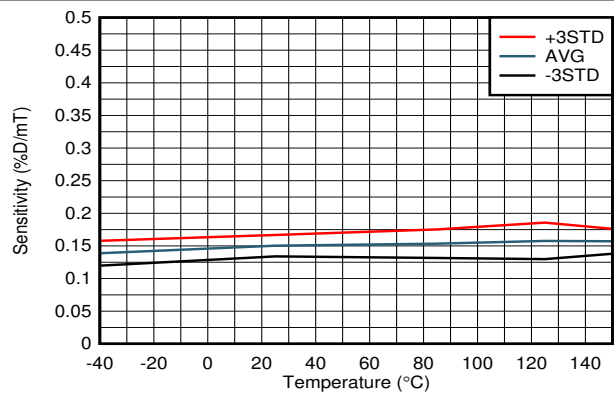

DRV5057Z4, $V_{CC} = 3.3\text{ V}$

Figure 6-22. Sensitivity vs Temperature

7 Detailed Description

7.1 Overview

The DRV5057 is a 3-pin pulse-width modulation (PWM) output Hall effect sensor with fully integrated signal conditioning, temperature compensation circuits, mechanical stress cancellation, and amplifiers. The device operates from 3.3-V and 5-V ($\pm 10\%$) power supplies, measures magnetic flux density, and outputs a pulse-width modulated, 2-kHz digital signal.

7.2 Functional Block Diagram

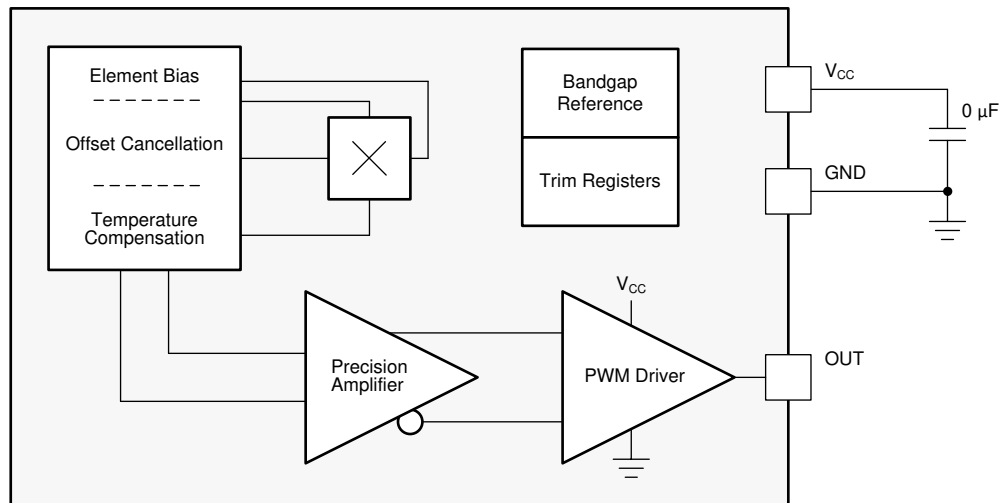

7.3 Feature Description

7.3.1 Magnetic Flux Direction

As shown in [Figure 7-1](#), the DRV5057 is sensitive to the magnetic field component that is perpendicular to the top of the package.

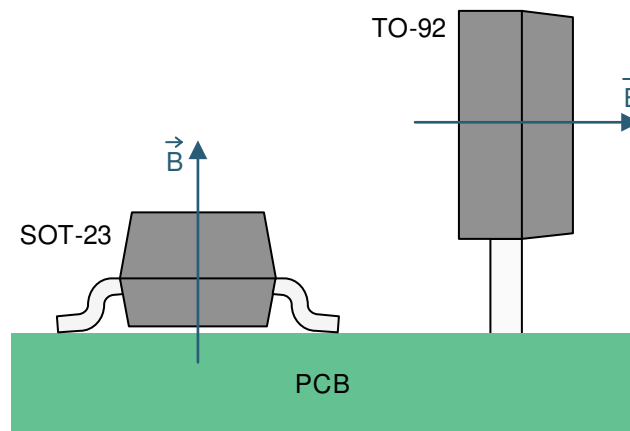

Figure 7-1. Direction of Sensitivity

Magnetic flux that travels from the bottom to the top of the package is considered positive in this document. This condition exists when a south magnetic pole is near the top (marked-side) of the package. Magnetic flux that travels from the top to the bottom of the package results in negative millitesla values. Figure 7-2 shows flux direction.

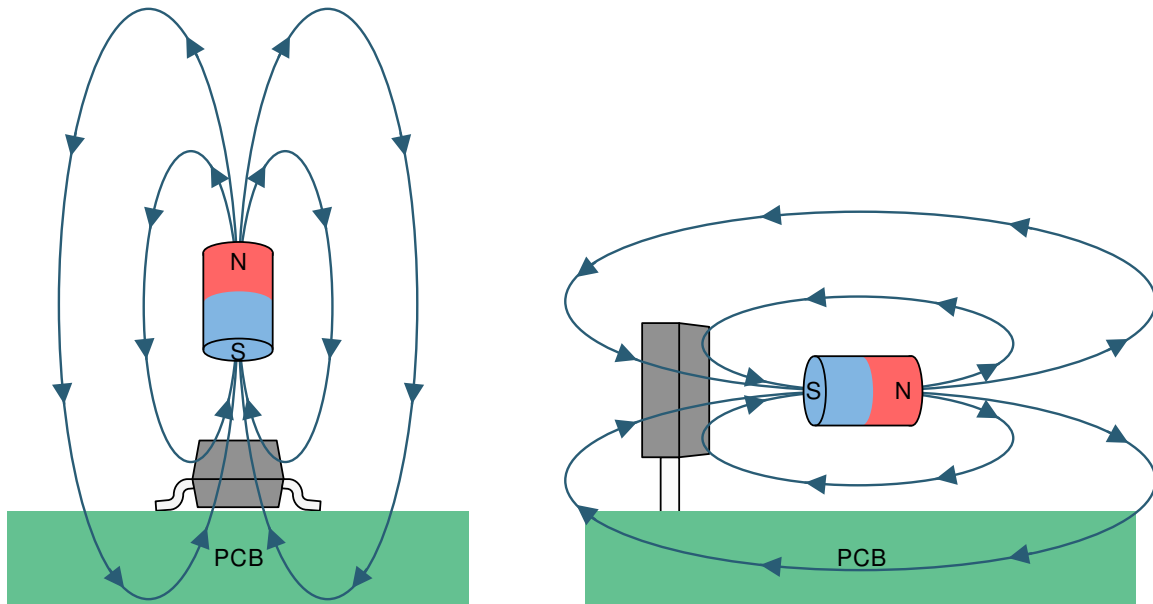

Figure 7-2. Flux Direction for Positive B

7.3.2 Sensitivity Linearity

The device produces a pulse-width modulated digital signal output. As shown in Figure 7-3, the duty-cycle of the PWM output signal is proportional to the magnetic field detected by the Hall element of the device. If there is no magnetic field present, the duty cycle is 50%. The DRV5057 can detect both magnetic north and south poles. The output duty cycle maintains a linear relationship with the input magnetic field from 8% to 92%.

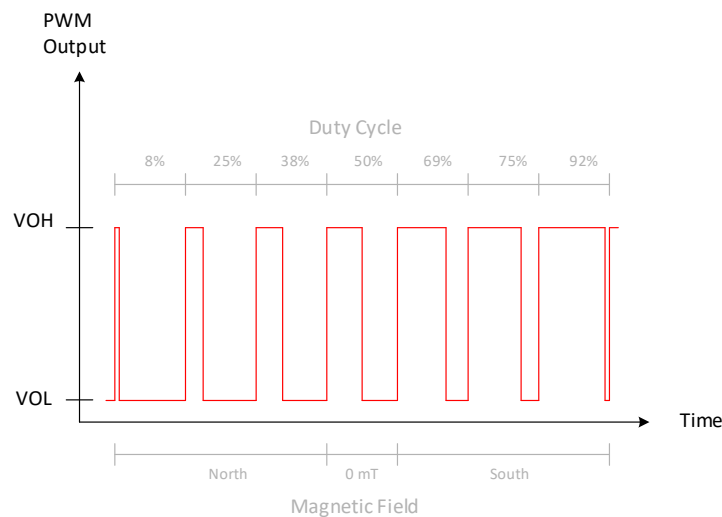

Figure 7-3. Magnetic Response

7.3.3 Operating V_{CC} Ranges

The DRV5057 has two recommended operating V_{CC} ranges: 3 V to 3.63 V and 4.5 V to 5.5 V. When V_{CC} is in the middle region between 3.63 V to 4.5 V, the device continues to function but sensitivity is less known because there is a crossover threshold near 4 V that adjusts device characteristics.

7.3.4 Sensitivity Temperature Compensation for Magnets

Magnets generally produce weaker fields as temperature increases. The DRV5057A1 - DRV5057A4 device options have a temperature compensation feature that is designed to directly compensate the average drift of neodymium (NdFeB) magnets and partially compensate ferrite magnets. The residual induction (B_r) of a magnet typically reduces by 0.12%/°C for NdFeB, and 0.20%/°C for ferrite. When the operating temperature of a system is reduced, temperature drift errors are also reduced. The DRV5057Z1 - DRV5057Z4 devices options do not compensate for the drift external magnets

7.3.5 Power-On Time

After the V_{CC} voltage is applied, the DRV5057 requires a short initialization time before the output is set. The parameter t_{ON} describes the time from when V_{CC} crosses 3 V until OUT is within 5% of V_Q , with 0 mT applied and no load attached to OUT. Figure 7-4 shows this timing diagram.

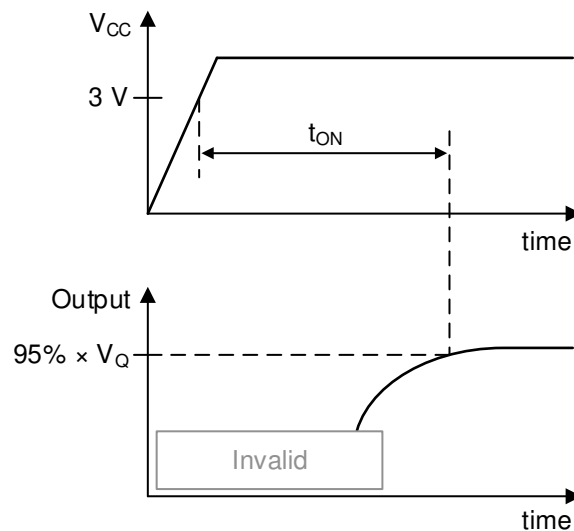

Figure 7-4. t_{ON} Definition

7.3.6 Hall Element Location

Figure 7-5 shows the location of the sensing element inside each package option.

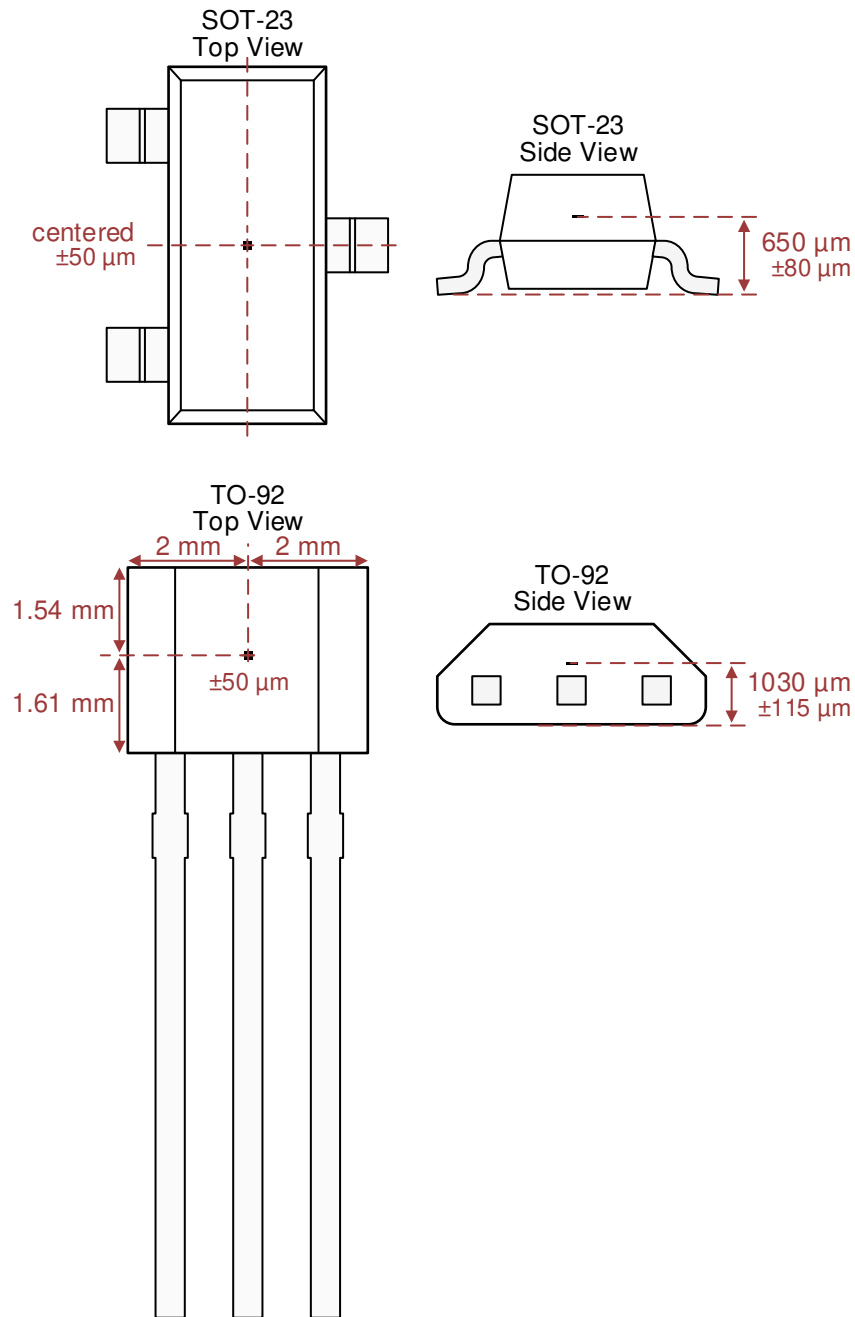

Figure 7-5. Hall Element Location

7.4 Device Functional Modes

The DRV5057 has one mode of operation that applies when the *Recommended Operating Conditions* are met.

8 Application and Implementation

Note

Information in the following applications sections is not part of the TI component specification, and TI does not warrant its accuracy or completeness. TI's customers are responsible for determining suitability of components for their purposes. Customers should validate and test their design implementation to confirm system functionality.

8.1 Application Information

8.1.1 Selecting the Sensitivity Option

Select the highest DRV5057 sensitivity option that can measure the required range of magnetic flux density so that the output voltage swing is maximized.

Larger-sized magnets and farther sensing distances can generally enable better positional accuracy than very small magnets at close distances, because magnetic flux density increases exponentially with the proximity to a magnet. TI created an online tool to help with simple magnet calculations on the DRV5057 [product folder](#).

8.1.2 Decoding a PWM

A PWM output helps system designers drive signals for long distances in noisy environments, with the ability to retrieve the signal accurately. A decoder is employed at the load to retrieve the analog magnetic signal. Two different methods of decoding are discussed in this section.

8.1.2.1 Decoding a PWM (Digital)

8.1.2.1.1 Capture and Compare Timer Interrupt

Many microcontrollers have a capture and compare timer mode that can simplify the PWM decoding process. Use the timer in capture and compare mode with an interrupt that triggers on both the rising and falling edges of the signal to obtain both the relative high (on) and low (off) time of the PWM. Make sure that the timer period is significantly faster than the period of the PWM, based on the desired resolution. Calculate the percent duty cycle (%D) of the PWM with [Equation 1](#) by using the relative on and off time of the signal.

$$\%D = \frac{\text{OnTime}}{\text{OnTime} + \text{OffTime}} \times 100 \quad (1)$$

8.1.2.1.2 Oversampling and Counting With a Timer Interrupt

If a capture and compare timer is not available, a standard timer interrupt and a counter can be used. Configure the timer interrupt to be significantly faster than the period of the PWM, based on the desired resolution. Count how many times the timer interrupts while the signal is high (OnTime), then count how many times the timer interrupts while the signal is low (OffTime). Then use [Equation 1](#) to calculate the duty cycle.

8.1.2.1.3 Accuracy and Resolution

The accuracy and resolution for the methods described in the [Section 8.1.2.1.1](#) and [Section 8.1.2.1.2](#) sections depends significantly on the timer sampling frequency. [Equation 2](#) calculates the least significant bit of the duty cycle (%D_{LSB}) based on the chosen timer sampling frequency.

$$\%D_{\text{LSB}} = \frac{\text{PWM}_{\text{frequency}}}{\text{TIMER}_{\text{frequency}}} \times 100 \quad (2)$$

For example, with a 2-kHz PWM and a 400-kHz sampling frequency, the %D_{LSB} is:

$$(2 \text{ kHz} / 400 \text{ kHz}) \times 100 = 0.5\%D_{\text{LSB}}$$

If the sampling frequency is increased to 2-MHz, the %D_{LSB} is improved to be:

$$(2 \text{ MHz} / 400 \text{ kHz}) \times 100 = 0.1\%D_{\text{LSB}}$$

However, accuracy and resolution are still subject to noise and sensitivity.

8.1.2.2 Decoding a PWM (Analog)

If an analog signal is needed at the end of a large travel distance, first use a microcontroller to digitally decode the PWM, then use a DAC to produce the analog signal. If an analog signal is needed after a short signal travel distance, use an analog output device, such as the [DRV5055](#).

If an analog signal is needed at the end of a large travel distance and a microcontroller is unavailable, use a low-pass filter to convert the PWM signal into an analog voltage, as shown in [Figure 8-1](#). When using this method, note the following:

- A ripple appears at the analog voltage output, causing a decrease in accuracy. The ripple intensity and frequency depend on the values chosen for R and C in the filter.
- The minimum and maximum voltages of the PWM must be known to calculate the magnetic field strength from the analog voltage. Thus, if the signal is traveling a large distance, then the minimum and maximum values must be either measured or buffered back to a known value.

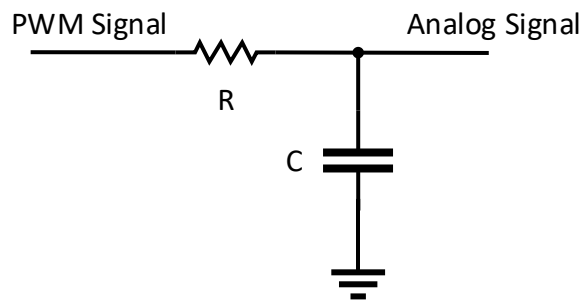

Figure 8-1. Low-Pass RC Filter

8.2 Typical Applications

The DRV557-Q1 is a very robust linear position sensor for applications such as throttle positions, brakes, and clutch pedals. In linear position applications, depending on the mechanical placement and design limitations, two common types of magnet orientations are selected: full-swing and half-swing.

8.2.1 Full-Swing Orientation Example

In the full-swing orientation, a magnet travels in parallel to the DRV5057-Q1 surface. In this case, the magnetic range extends from south polarity to north polarity, and allows the DRV5057-Q1 to use the full linear magnetic flux density sensing range.

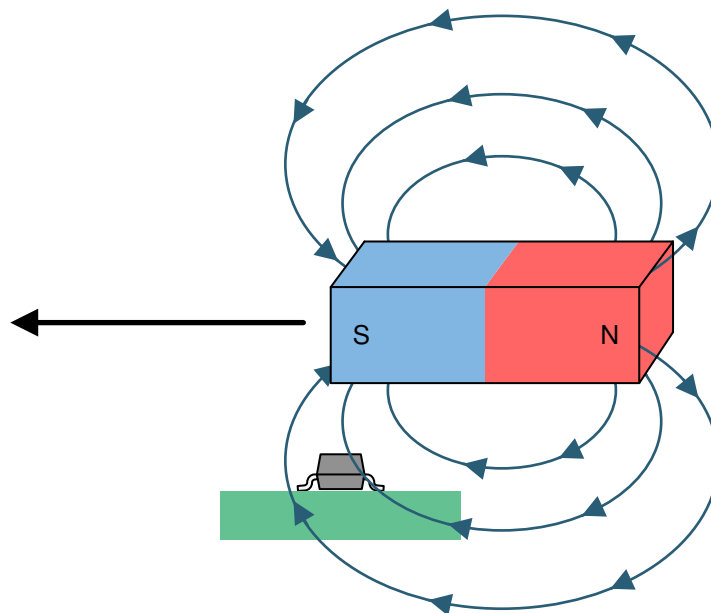

Figure 8-2. Full-Swing Orientation Example

8.2.1.1 Design Requirements

Use the parameters listed in [Table 8-1](#) for this design example.

Table 8-1. Design Parameters

DESIGN PARAMETER	EXAMPLE VALUE
Device	DRV5057
V _{CC}	5 V
Magnet	Cylinder: 4.7625-mm diameter, 12.7-mm thick, neodymium N52, Br = 1480 mT
Travel distance	10 mm
Desired accuracy	< 0.1 mm

8.2.1.2 Detailed Design Procedure

Linear Hall effect sensors provide flexibility in mechanical design because many possible magnet orientations and movements produce a usable response from the sensor. [Figure 8-2](#) illustrates one of the most common orientations that uses the full north to south range of the sensor and causes a close-to-linear change in magnetic flux density as the magnet moves across the sensor. [Figure 8-3](#) illustrates the close-to-linear change in magnetic field present at the sensor as the magnet moves a given distance across the sensor. The usable linear region is close to but less than the length (thickness) of the magnet.

When designing a linear magnetic sensing system, always consider these three variables: the magnet, sensing distance, and the range of the sensor. Select the DRV5057 with the highest sensitivity possible based on the system distance requirements without raiing the sensor PWM output. To determine the magnetic flux density the sensor receives at the various positions of the magnet, use a magnetic field calculator or simulation software, referring to magnet specifications, and testing.

Determine if the desired accuracy is met by comparing the maximum allowed duty cycle least significant bit (%D_{LSBmax}) with the noise level (PWM jitter) of the device. [Equation 3](#) calculates the %D_{LSBmax} by taking into account the used length of the linear region (travel distance), the desired resolution, and the output PWM swing (within the linear duty cycle range).

$$\%D_{LSBmax} = \frac{\%D_{swing}}{Travel\ Distance} \times Resolution \tag{3}$$

Thus, with this example (and a linear duty cycle range of 8%D to 92%D), using Equation 3 gives $(92 - 8) / (10) \times 0.1 = 0.84\%D_{LSB_{max}}$. This value is larger than the 0.1%D jitter, and therefore the desired accuracy can be achieved by using Equation 2 to select a $\%D_{LSB}$ that is equal to or less than 0.84. Then, simply calibrate the magnet position to align the sensor output along the movement path.

8.2.1.3 Application Curve

Figure 8-3 shows the magnetic field present at the sensor as the magnet passes by as described in Figure 8-2. The change in distance from the trough to the peak is approximately the length (thickness) of the magnet. B changes based on the strength of the magnet and how close the magnet is to the sensor.

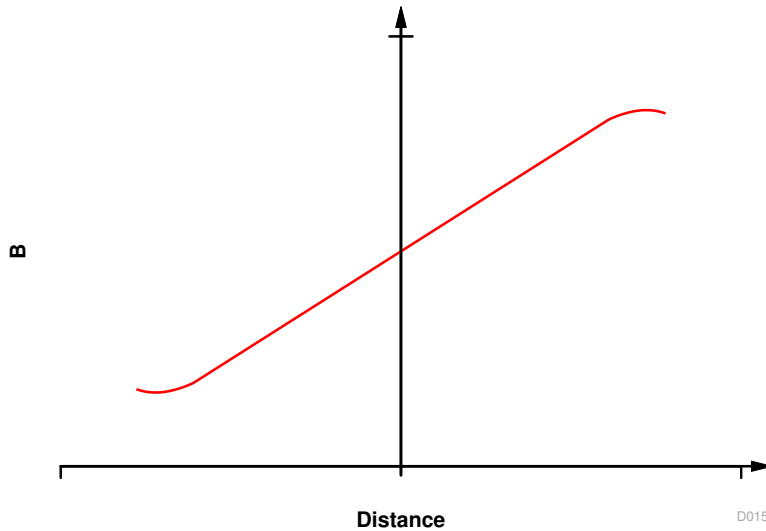

Figure 8-3. Magnetic Field vs Distance

8.2.2 Half-Swing Orientation Example

In the half-swing orientation, a magnet travels perpendicular to the DRV5057-Q1 surface. In this case, the magnetic range extends only to either the south or north pole, using only half of the DRV5057-Q1 linear magnetic flux density sensing range.

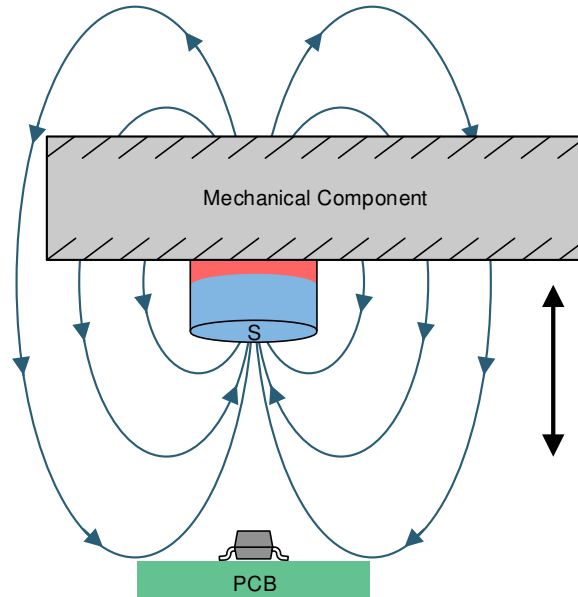

Figure 8-4. Half-Swing Orientation Example

8.2.2.1 Design Requirements

Use the parameters listed in [Table 8-2](#) for this design example.

Table 8-2. Design Parameters

DESIGN PARAMETER	EXAMPLE VALUE
Device	DRV5057
V_{CC}	5 V
Magnet	Cylinder: 4.7625 mm diameter, 12.7 mm thick, Neodymium N52, $B_r = 1480$ mT
Travel distance	5 mm
Desired accuracy	< 0.1 mm

8.2.2.2 Detailed Design Procedure

As illustrated in [Figure 8-4](#), this design example consists of a mechanical component that moves back and forth, an embedded magnet with the south pole facing the printed-circuit board, and a DRV5057. The DRV5057 outputs a PWM that describes the precise position of the component. The component must not contain ferromagnetic materials such as iron, nickel, and cobalt because these materials change the magnetic flux density at the sensor.

When designing a linear magnetic sensing system, always consider these three variables: the magnet, sensing distance, and the range of the sensor. Select the DRV5057 with the highest sensitivity possible based on the system distance requirements without railing the sensor PWM output. To determine the magnetic flux density the sensor receives at the various positions of the magnet, use a magnetic field calculator or simulation software, referring to magnet specifications, and testing.

Magnets are made from various ferromagnetic materials that have tradeoffs in cost, drift with temperature, absolute maximum temperature ratings, remanence or residual induction (B_r), and coercivity (H_c). The B_r and the dimensions of a magnet determine the magnetic flux density (B) produced in 3-dimensional space. For simple

magnet shapes, such as rectangular blocks and cylinders, there are simple equations that solve B at a given distance centered with the magnet. [Figure 8-5](#) shows diagrams for [Equation 4](#) and [Equation 5](#).

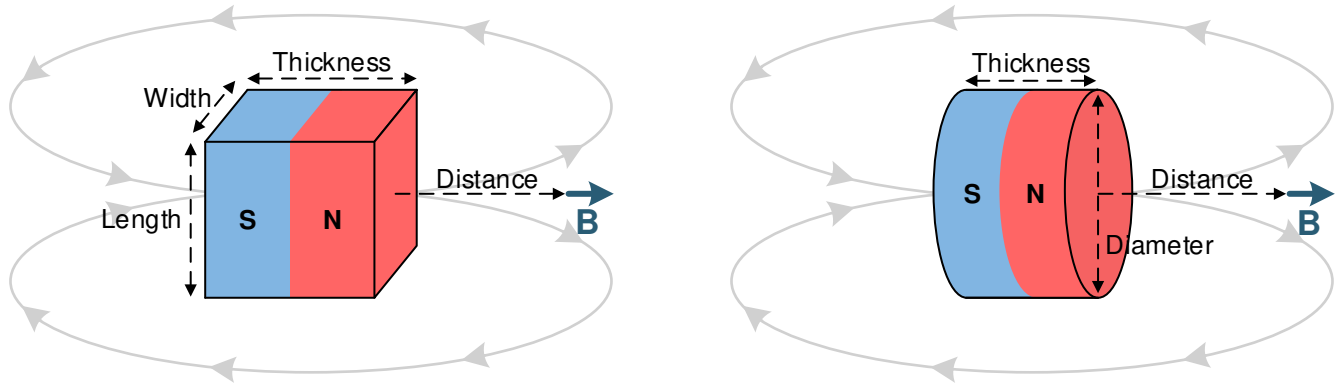

Figure 8-5. Rectangular Block and Cylinder Magnets

Use [Equation 4](#) for the rectangular block shown in [Figure 8-5](#):

$$\vec{B} = \frac{B_r}{\pi} \left(\arctan\left(\frac{WL}{2D\sqrt{4D^2 + W^2 + L^2}}\right) - \arctan\left(\frac{WL}{2(D+T)\sqrt{4(D+T)^2 + W^2 + L^2}}\right) \right) \quad (4)$$

Use [Equation 5](#) for the cylinder illustrated in [Figure 8-5](#):

$$\vec{B} = \frac{B_r}{2} \left(\frac{D+T}{\sqrt{(0.5C)^2 + (D+T)^2}} - \frac{D}{\sqrt{(0.5C)^2 + D^2}} \right) \quad (5)$$

where:

- W is width
- L is length
- T is thickness (the direction of magnetization)
- D is distance
- C is diameter

This example uses a cylinder magnet; therefore, [Equation 5](#) can be used to create a lookup table for the distances from a specific magnet based on a magnetic field strength. [Figure 8-6](#) shows a magnetic field from 0 mm to 16 mm with the magnet defined in [Table 8-2](#) as C = 4.7625 mm, T = 12.7 mm, and B_r = 1480 mT.

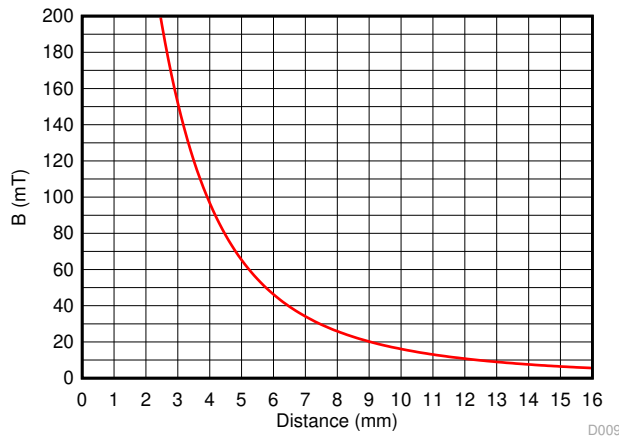

Figure 8-6. Magnetic Field vs Distance

In this setup, each gain version of the sensor produces the corresponding duty cycle shown in Figure 8-7 for 0 mm to 16 mm.

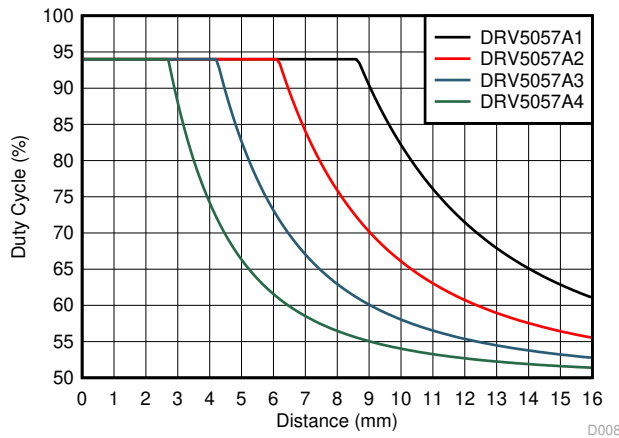

Figure 8-7. %D vs South Pole Distance (All Gains)

With a desired 5-mm movement swing, select the DRV5057 with the largest possible sensitivity that fits the system requirements for the magnet distance to the sensor. Assume that for this example, because of mechanical restrictions, the magnet at the nearest point to the sensor must be selected to be within 5 mm to 8 mm. The largest sensitivity option (A1) does not work in this situation because the device output is railed at the farthest allowed distance of 8 mm. The A2 version is not railed at this point, and is therefore the sensor selected for this example. Choose the closest point of the magnet to the sensor to be a distance that allows the magnet to get as close to the sensor as possible without railing but stays within the selectable 5-mm to 8-mm allowed range. Because the A2 version rails at approximately 6 mm, choose a closest distance of 6.5 mm to allow for a little bit of margin. With this choice, Figure 8-8 shows the %D response at the sensor across the full movement range.

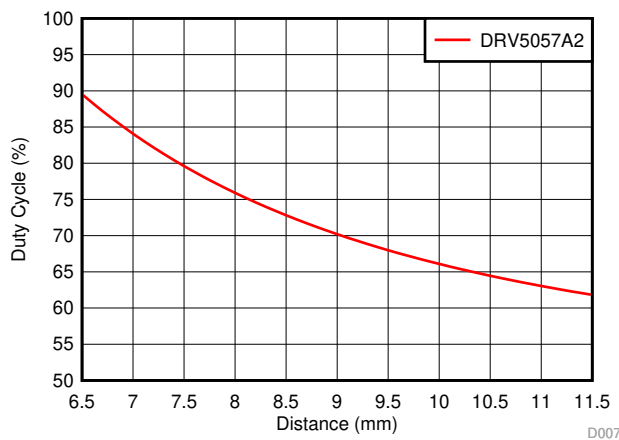

Figure 8-8. %D vs South Pole Distance (Gain A2)

The magnetic field strength is calculated using [Equation 6](#), where a negative number represents the opposite pole (in this example a south pole is over the sensor, causing the results to be a positive number).

$$B = \frac{(\%D - 50)}{\text{Gain}} \quad (6)$$

For example, if the A2 version of the DRV5057 measured a duty cycle of $\%D = 74.6\%$ using [Equation 1](#), then the magnetic field strength present at the sensor is $(74.6 - 50) / 1 = 24.6$ mT.

Using the lookup table that was used to create the plot in [Figure 8-6](#), the distance from the magnet at 24.6 mT is $D \approx 8.2$ mm.

For more accurate results, the lookup table can be calibrated along the movement path of the magnet. Additionally, instead of using the calibrated lookup table for each measurement, consider using a best-fit polynomial equation from the curve for the desired movement range to calculate D in terms of B.

The curve in [Figure 8-8](#) is not linear; therefore, the achievable accuracy varies for each position along the movement path. The location with the worst accuracy is where there is the smallest change in output for a given amount of movement, which in this example is where the magnet is farthest from the sensor (at 11.5 mm). Determine if the desired accuracy is met by checking if the needed $\%D_{LSB}$ at this location for the specified accuracy is greater than the noise level (PWM jitter) of 0.1%D. Thus, with a desired accuracy of 0.1 mm, the needed $\%D_{LSB}$ is the change in %D between 11.4 mm and 11.5 mm. Using the lookup table to find B and then solving for %D in [Equation 6](#), at 11.5 mm, $B = 11.815$ mT (which equates to 61.815%D), and at 11.4 mm $B = 12.048$ mT (which equates to 62.048%D). The difference in %D between these two points is $62.048 - 61.815 = 0.223\%D_{LSB}$. This value is larger than the 0.1%D jitter, so the desired accuracy can be met as long as a $\%D_{LSB}$ is selected that is equal to or less than 0.223 using [Equation 2](#).

8.3 What to Do and What Not to Do

The Hall element is sensitive to magnetic fields that are perpendicular to the top of the package. Therefore, to correctly detect the magnetic field, make sure to use the correct magnet orientation for the sensor. Figure 8-9 shows correct and incorrect orientation.

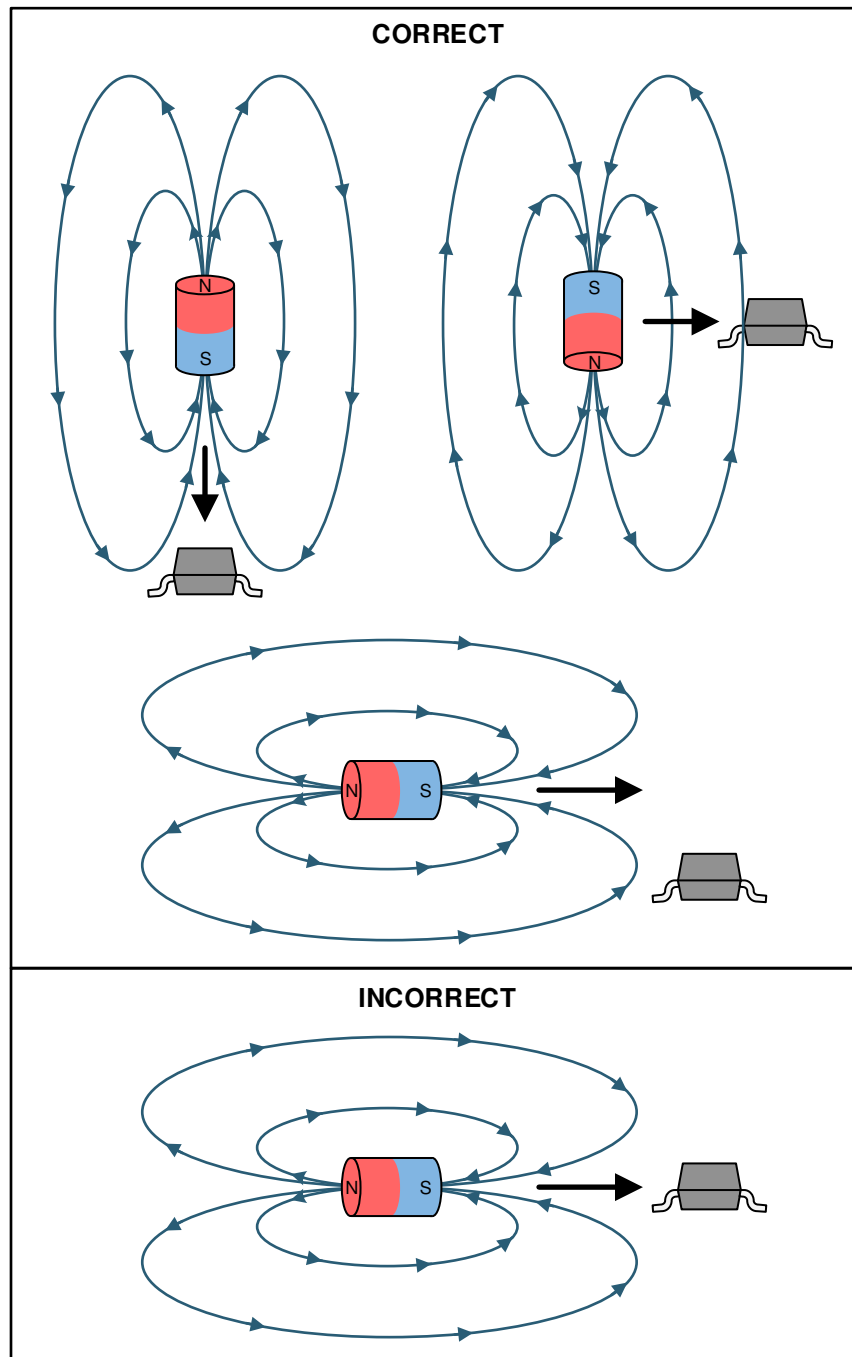

Figure 8-9. Correct and Incorrect Magnet Orientation

9 Power Supply Recommendations

Use a decoupling capacitor placed close to the device to provide local energy with minimal inductance. Use a ceramic capacitor with a value of at least 0.01 μF .

10 Layout

10.1 Layout Guidelines

Magnetic fields pass through most nonferromagnetic materials with no significant disturbance. Embedding Hall effect sensors within plastic or aluminum enclosures and sensing magnets on the outside is common practice. Magnetic fields also easily pass through most printed-circuit boards, which makes placing the magnet on the opposite side possible.

10.2 Layout Examples

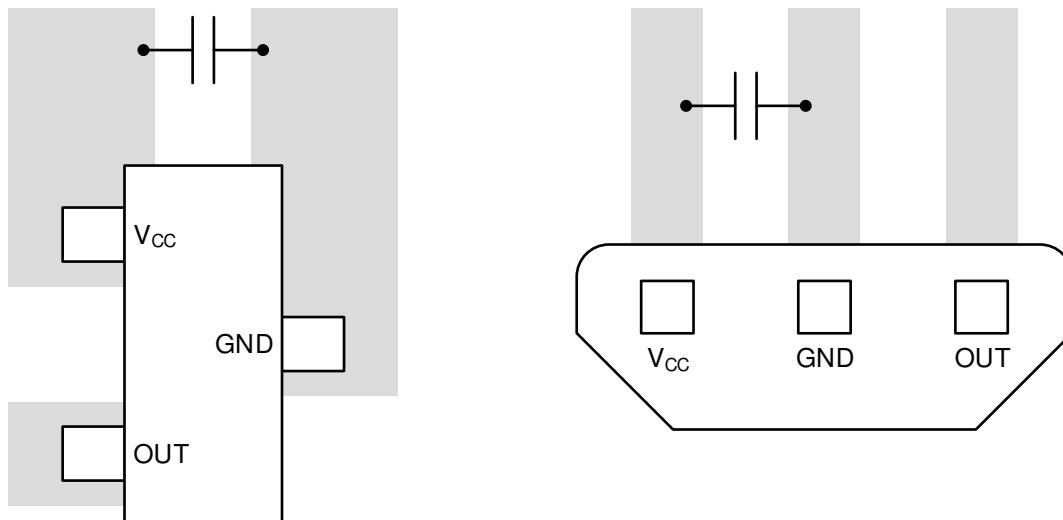

Figure 10-1. Layout Examples

11 Device and Documentation Support

11.1 Documentation Support

11.1.1 Related Documentation

For related documentation see the following:

- Texas Instruments, [Using Linear Hall Effect Sensors to Measure Angle tech note](#)
- Texas Instruments, [Incremental Rotary Encoder Design Considerations tech note](#)
- Texas Instruments, [DRV5055 Ratiometric Linear Hall Effect Sensor data sheet](#)

11.2 Receiving Notification of Documentation Updates

To receive notification of documentation updates, navigate to the device product folder on ti.com. Click on *Subscribe to updates* to register and receive a weekly digest of any product information that has changed. For change details, review the revision history included in any revised document.

11.3 Support Resources

TI E2E™ [support forums](#) are an engineer's go-to source for fast, verified answers and design help — straight from the experts. Search existing answers or ask your own question to get the quick design help you need.

Linked content is provided "AS IS" by the respective contributors. They do not constitute TI specifications and do not necessarily reflect TI's views; see TI's [Terms of Use](#).

11.4 Trademarks

TI E2E™ is a trademark of Texas Instruments.

All other trademarks are the property of their respective owners.

11.5 Electrostatic Discharge Caution



This integrated circuit can be damaged by ESD. Texas Instruments recommends that all integrated circuits be handled with appropriate precautions. Failure to observe proper handling and installation procedures can cause damage.

ESD damage can range from subtle performance degradation to complete device failure. Precision integrated circuits may be more susceptible to damage because very small parametric changes could cause the device not to meet its published specifications.

11.6 Glossary

TI Glossary This glossary lists and explains terms, acronyms, and definitions.

12 Mechanical, Packaging, and Orderable Information

The following pages include mechanical, packaging, and orderable information. This information is the most current data available for the designated devices. This data is subject to change without notice and revision of this document. For browser-based versions of this data sheet, refer to the left-hand navigation.

PACKAGING INFORMATION

Orderable Device	Status (1)	Package Type	Package Drawing	Pins	Package Qty	Eco Plan (2)	Lead finish/ Ball material (6)	MSL Peak Temp (3)	Op Temp (°C)	Device Marking (4/5)	Samples
DRV5057A1QDBZR	ACTIVE	SOT-23	DBZ	3	3000	RoHS & Green	SN	Level-2-260C-1 YEAR	-40 to 125	57A1	Samples
DRV5057A1QDBZT	ACTIVE	SOT-23	DBZ	3	250	RoHS & Green	SN	Level-2-260C-1 YEAR	-40 to 125	57A1	Samples
DRV5057A1QLPG	ACTIVE	TO-92	LPG	3	1000	RoHS & Green	SN	N / A for Pkg Type	-40 to 125	57A1	Samples
DRV5057A1QLPGM	ACTIVE	TO-92	LPG	3	3000	RoHS & Green	SN	N / A for Pkg Type	-40 to 125	57A1	Samples
DRV5057A2QDBZR	ACTIVE	SOT-23	DBZ	3	3000	RoHS & Green	SN	Level-2-260C-1 YEAR	-40 to 125	57A2	Samples
DRV5057A2QDBZT	ACTIVE	SOT-23	DBZ	3	250	RoHS & Green	SN	Level-2-260C-1 YEAR	-40 to 125	57A2	Samples
DRV5057A2QLPG	ACTIVE	TO-92	LPG	3	1000	RoHS & Green	SN	N / A for Pkg Type	-40 to 125	57A2	Samples
DRV5057A2QLPGM	ACTIVE	TO-92	LPG	3	3000	RoHS & Green	SN	N / A for Pkg Type	-40 to 125	57A2	Samples
DRV5057A3QDBZR	ACTIVE	SOT-23	DBZ	3	3000	RoHS & Green	SN	Level-2-260C-1 YEAR	-40 to 125	57A3	Samples
DRV5057A3QDBZT	ACTIVE	SOT-23	DBZ	3	250	RoHS & Green	SN	Level-2-260C-1 YEAR	-40 to 125	57A3	Samples
DRV5057A3QLPG	ACTIVE	TO-92	LPG	3	1000	RoHS & Green	SN	N / A for Pkg Type	-40 to 125	57A3	Samples
DRV5057A3QLPGM	ACTIVE	TO-92	LPG	3	3000	RoHS & Green	SN	N / A for Pkg Type	-40 to 125	57A3	Samples
DRV5057A4QDBZR	ACTIVE	SOT-23	DBZ	3	3000	RoHS & Green	SN	Level-2-260C-1 YEAR	-40 to 125	57A4	Samples
DRV5057A4QDBZT	ACTIVE	SOT-23	DBZ	3	250	RoHS & Green	SN	Level-2-260C-1 YEAR	-40 to 125	57A4	Samples
DRV5057A4QLPG	ACTIVE	TO-92	LPG	3	1000	RoHS & Green	SN	N / A for Pkg Type	-40 to 125	57A4	Samples
DRV5057A4QLPGM	ACTIVE	TO-92	LPG	3	3000	RoHS & Green	SN	N / A for Pkg Type	-40 to 125	57A4	Samples
DRV5057Z1QDBZR	ACTIVE	SOT-23	DBZ	3	3000	RoHS & Green	SN	Level-2-260C-1 YEAR	-40 to 125	57Z1	Samples
DRV5057Z1QDBZT	ACTIVE	SOT-23	DBZ	3	250	RoHS & Green	SN	Level-2-260C-1 YEAR	-40 to 125	57Z1	Samples
DRV5057Z2QDBZR	ACTIVE	SOT-23	DBZ	3	3000	RoHS & Green	SN	Level-2-260C-1 YEAR	-40 to 125	57Z2	Samples
DRV5057Z2QDBZT	ACTIVE	SOT-23	DBZ	3	250	RoHS & Green	SN	Level-2-260C-1 YEAR	-40 to 125	57Z2	Samples

Orderable Device	Status (1)	Package Type	Package Drawing	Pins	Package Qty	Eco Plan (2)	Lead finish/ Ball material (6)	MSL Peak Temp (3)	Op Temp (°C)	Device Marking (4/5)	Samples
DRV5057Z3QDBZR	ACTIVE	SOT-23	DBZ	3	3000	RoHS & Green	SN	Level-2-260C-1 YEAR	-40 to 125	57Z3	Samples
DRV5057Z3QDBZT	ACTIVE	SOT-23	DBZ	3	250	RoHS & Green	SN	Level-2-260C-1 YEAR	-40 to 125	57Z3	Samples
DRV5057Z4QDBZR	ACTIVE	SOT-23	DBZ	3	3000	RoHS & Green	SN	Level-2-260C-1 YEAR	-40 to 125	57Z4	Samples
DRV5057Z4QDBZT	ACTIVE	SOT-23	DBZ	3	250	RoHS & Green	SN	Level-2-260C-1 YEAR	-40 to 125	57Z4	Samples

(1) The marketing status values are defined as follows:

ACTIVE: Product device recommended for new designs.

LIFEBUY: TI has announced that the device will be discontinued, and a lifetime-buy period is in effect.

NRND: Not recommended for new designs. Device is in production to support existing customers, but TI does not recommend using this part in a new design.

PREVIEW: Device has been announced but is not in production. Samples may or may not be available.

OBSOLETE: TI has discontinued the production of the device.

(2) **RoHS:** TI defines "RoHS" to mean semiconductor products that are compliant with the current EU RoHS requirements for all 10 RoHS substances, including the requirement that RoHS substance do not exceed 0.1% by weight in homogeneous materials. Where designed to be soldered at high temperatures, "RoHS" products are suitable for use in specified lead-free processes. TI may reference these types of products as "Pb-Free".

RoHS Exempt: TI defines "RoHS Exempt" to mean products that contain lead but are compliant with EU RoHS pursuant to a specific EU RoHS exemption.

Green: TI defines "Green" to mean the content of Chlorine (Cl) and Bromine (Br) based flame retardants meet JS709B low halogen requirements of <=1000ppm threshold. Antimony trioxide based flame retardants must also meet the <=1000ppm threshold requirement.

(3) MSL, Peak Temp. - The Moisture Sensitivity Level rating according to the JEDEC industry standard classifications, and peak solder temperature.

(4) There may be additional marking, which relates to the logo, the lot trace code information, or the environmental category on the device.

(5) Multiple Device Markings will be inside parentheses. Only one Device Marking contained in parentheses and separated by a "~" will appear on a device. If a line is indented then it is a continuation of the previous line and the two combined represent the entire Device Marking for that device.

(6) Lead finish/Ball material - Orderable Devices may have multiple material finish options. Finish options are separated by a vertical ruled line. Lead finish/Ball material values may wrap to two lines if the finish value exceeds the maximum column width.

Important Information and Disclaimer: The information provided on this page represents TI's knowledge and belief as of the date that it is provided. TI bases its knowledge and belief on information provided by third parties, and makes no representation or warranty as to the accuracy of such information. Efforts are underway to better integrate information from third parties. TI has taken and continues to take reasonable steps to provide representative and accurate information but may not have conducted destructive testing or chemical analysis on incoming materials and chemicals. TI and TI suppliers consider certain information to be proprietary, and thus CAS numbers and other limited information may not be available for release.

In no event shall TI's liability arising out of such information exceed the total purchase price of the TI part(s) at issue in this document sold by TI to Customer on an annual basis.

OTHER QUALIFIED VERSIONS OF DRV5057 :

- Automotive: [DRV5057-Q1](#)

NOTE: Qualified Version Definitions:

- Automotive - Q100 devices qualified for high-reliability automotive applications targeting zero defects

TAPE AND REEL INFORMATION



QUADRANT ASSIGNMENTS FOR PIN 1 ORIENTATION IN TAPE



*All dimensions are nominal

Device	Package Type	Package Drawing	Pins	SPQ	Reel Diameter (mm)	Reel Width W1 (mm)	A0 (mm)	B0 (mm)	K0 (mm)	P1 (mm)	W (mm)	Pin1 Quadrant
DRV5057A1QDBZR	SOT-23	DBZ	3	3000	180.0	8.4	3.15	2.77	1.22	4.0	8.0	Q3
DRV5057A1QDBZT	SOT-23	DBZ	3	250	180.0	8.4	3.15	2.77	1.22	4.0	8.0	Q3
DRV5057A2QDBZR	SOT-23	DBZ	3	3000	180.0	8.4	3.15	2.77	1.22	4.0	8.0	Q3
DRV5057A2QDBZT	SOT-23	DBZ	3	250	180.0	8.4	3.15	2.77	1.22	4.0	8.0	Q3
DRV5057A3QDBZR	SOT-23	DBZ	3	3000	180.0	8.4	3.15	2.77	1.22	4.0	8.0	Q3
DRV5057A3QDBZT	SOT-23	DBZ	3	250	180.0	8.4	3.15	2.77	1.22	4.0	8.0	Q3
DRV5057A4QDBZR	SOT-23	DBZ	3	3000	180.0	8.4	3.15	2.77	1.22	4.0	8.0	Q3
DRV5057A4QDBZT	SOT-23	DBZ	3	250	180.0	8.4	3.15	2.77	1.22	4.0	8.0	Q3
DRV5057Z1QDBZR	SOT-23	DBZ	3	3000	180.0	8.4	3.15	2.77	1.22	4.0	8.0	Q3
DRV5057Z1QDBZT	SOT-23	DBZ	3	250	180.0	8.4	3.15	2.77	1.22	4.0	8.0	Q3
DRV5057Z2QDBZR	SOT-23	DBZ	3	3000	180.0	8.4	3.15	2.77	1.22	4.0	8.0	Q3
DRV5057Z2QDBZT	SOT-23	DBZ	3	250	180.0	8.4	3.15	2.77	1.22	4.0	8.0	Q3
DRV5057Z3QDBZR	SOT-23	DBZ	3	3000	180.0	8.4	3.15	2.77	1.22	4.0	8.0	Q3
DRV5057Z3QDBZT	SOT-23	DBZ	3	250	180.0	8.4	3.15	2.77	1.22	4.0	8.0	Q3
DRV5057Z4QDBZR	SOT-23	DBZ	3	3000	180.0	8.4	3.15	2.77	1.22	4.0	8.0	Q3
DRV5057Z4QDBZT	SOT-23	DBZ	3	250	180.0	8.4	3.15	2.77	1.22	4.0	8.0	Q3

TAPE AND REEL BOX DIMENSIONS

*All dimensions are nominal

Device	Package Type	Package Drawing	Pins	SPQ	Length (mm)	Width (mm)	Height (mm)
DRV5057A1QDBZR	SOT-23	DBZ	3	3000	213.0	191.0	35.0
DRV5057A1QDBZT	SOT-23	DBZ	3	250	213.0	191.0	35.0
DRV5057A2QDBZR	SOT-23	DBZ	3	3000	213.0	191.0	35.0
DRV5057A2QDBZT	SOT-23	DBZ	3	250	213.0	191.0	35.0
DRV5057A3QDBZR	SOT-23	DBZ	3	3000	213.0	191.0	35.0
DRV5057A3QDBZT	SOT-23	DBZ	3	250	213.0	191.0	35.0
DRV5057A4QDBZR	SOT-23	DBZ	3	3000	213.0	191.0	35.0
DRV5057A4QDBZT	SOT-23	DBZ	3	250	213.0	191.0	35.0
DRV5057Z1QDBZR	SOT-23	DBZ	3	3000	213.0	191.0	35.0
DRV5057Z1QDBZT	SOT-23	DBZ	3	250	213.0	191.0	35.0
DRV5057Z2QDBZR	SOT-23	DBZ	3	3000	213.0	191.0	35.0
DRV5057Z2QDBZT	SOT-23	DBZ	3	250	213.0	191.0	35.0
DRV5057Z3QDBZR	SOT-23	DBZ	3	3000	213.0	191.0	35.0
DRV5057Z3QDBZT	SOT-23	DBZ	3	250	213.0	191.0	35.0
DRV5057Z4QDBZR	SOT-23	DBZ	3	3000	213.0	191.0	35.0
DRV5057Z4QDBZT	SOT-23	DBZ	3	250	213.0	191.0	35.0

LPG0003A



PACKAGE OUTLINE

TO-92 - 5.05 mm max height

TRANSISTOR OUTLINE

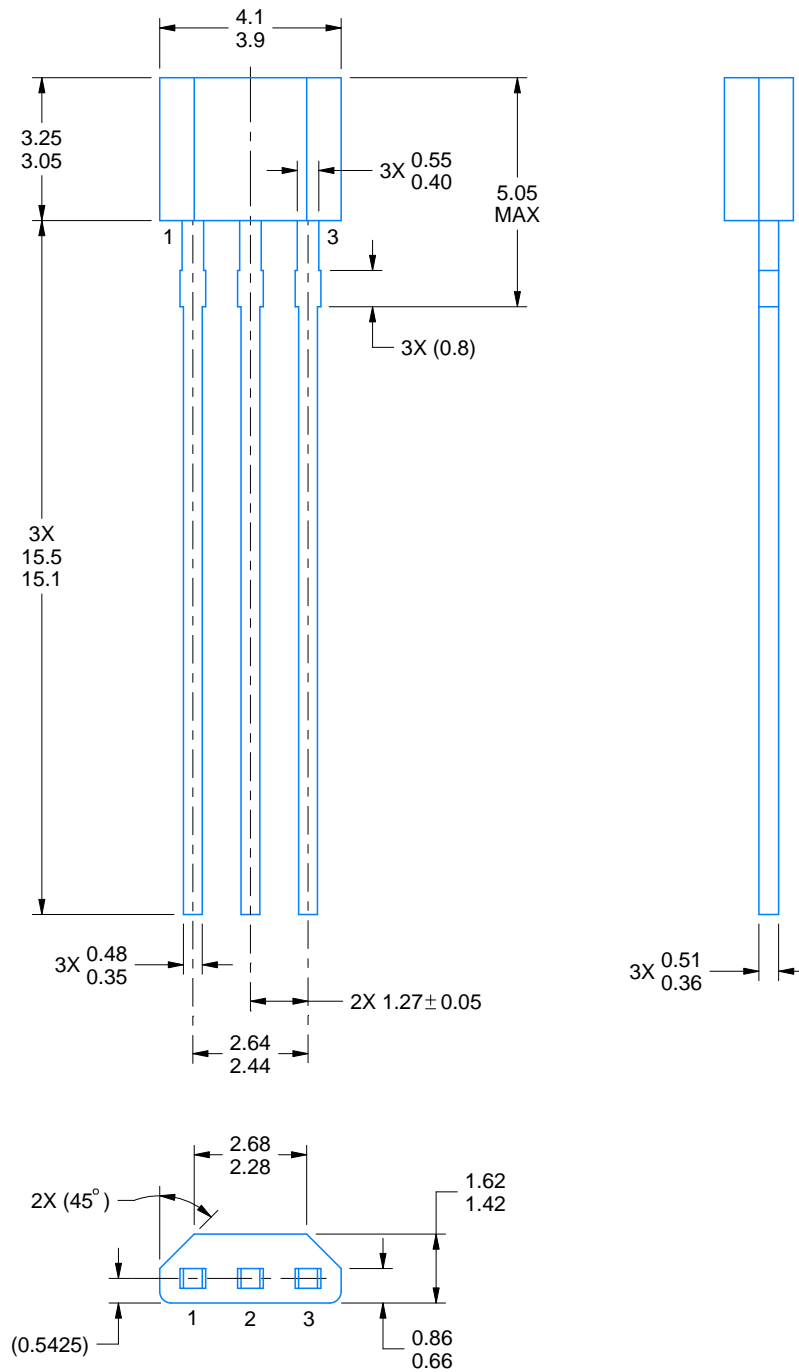

4221343/C 01/2018

NOTES:

1. All linear dimensions are in millimeters. Any dimensions in parenthesis are for reference only. Dimensioning and tolerancing per ASME Y14.5M.
2. This drawing is subject to change without notice.

EXAMPLE BOARD LAYOUT

LPG0003A

TO-92 - 5.05 mm max height

TRANSISTOR OUTLINE

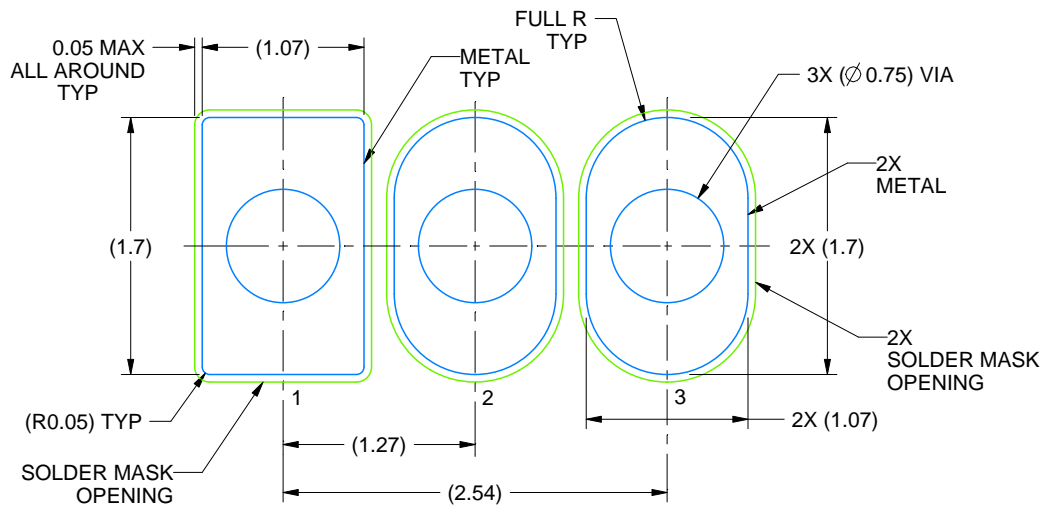

LAND PATTERN EXAMPLE
NON-SOLDER MASK DEFINED
SCALE:20X

4221343/C 01/2018

TAPE SPECIFICATIONS

LPG0003A

TO-92 - 5.05 mm max height

TRANSISTOR OUTLINE

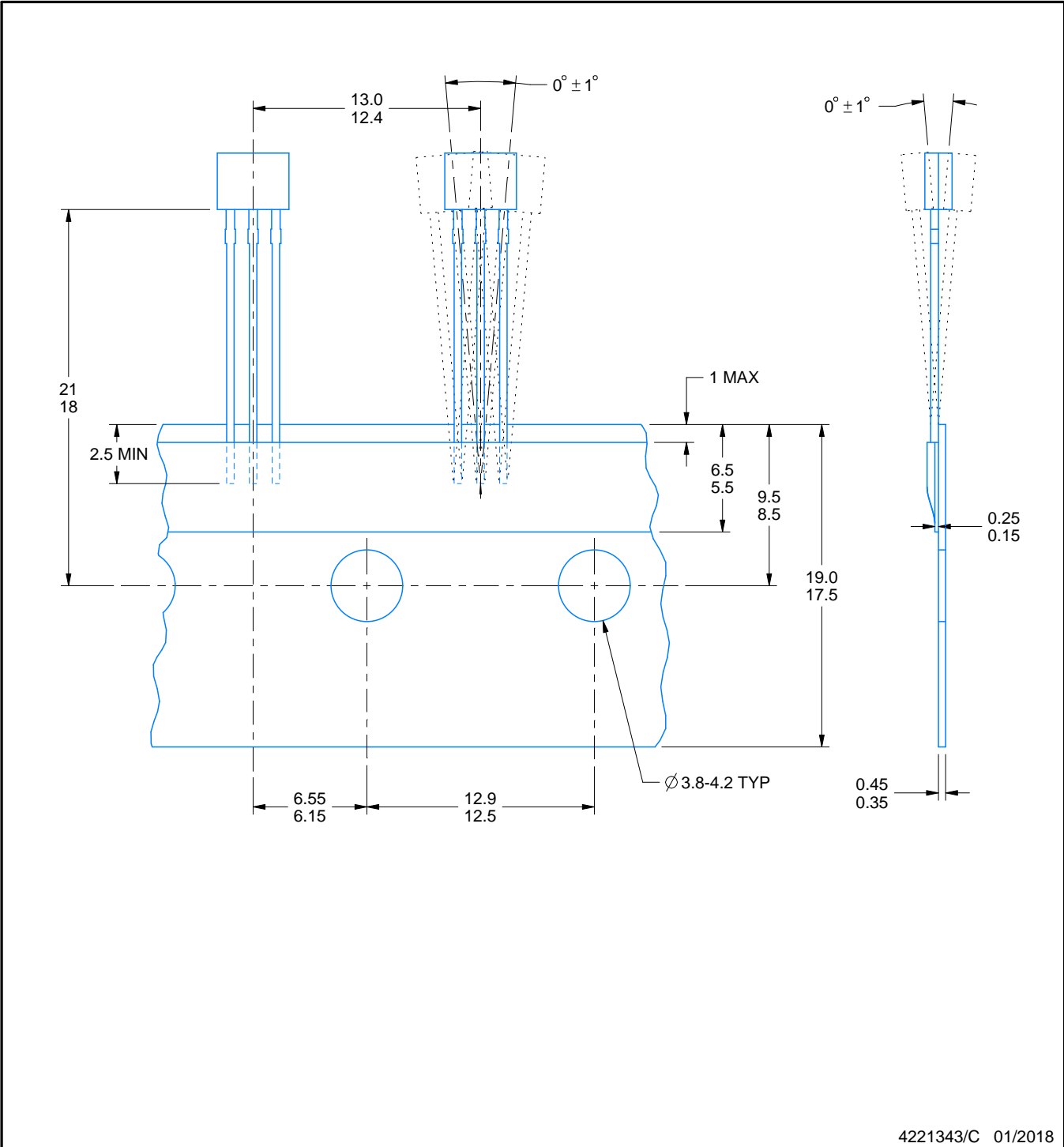

GENERIC PACKAGE VIEW

DBZ 3

SOT-23 - 1.12 mm max height

SMALL OUTLINE TRANSISTOR



Images above are just a representation of the package family, actual package may vary.
Refer to the product data sheet for package details.

4203227/C

DBZ0003A



PACKAGE OUTLINE

SOT-23 - 1.12 mm max height

SMALL OUTLINE TRANSISTOR

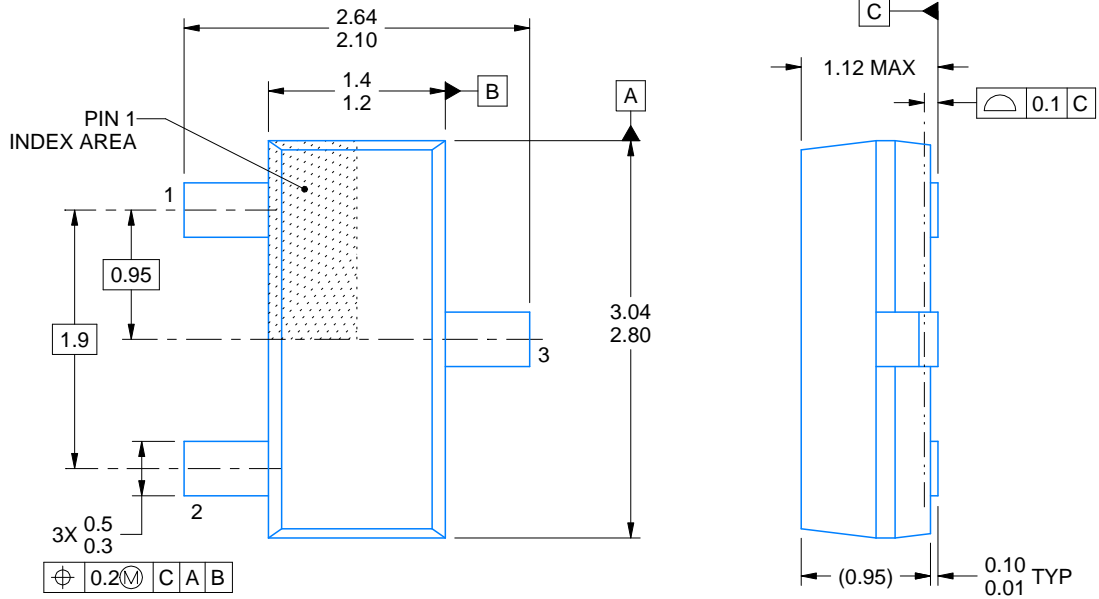

4214838/C 04/2017

NOTES:

1. All linear dimensions are in millimeters. Any dimensions in parenthesis are for reference only. Dimensioning and tolerancing per ASME Y14.5M.
2. This drawing is subject to change without notice.
3. Reference JEDEC registration TO-236, except minimum foot length.

EXAMPLE BOARD LAYOUT

DBZ0003A

SOT-23 - 1.12 mm max height

SMALL OUTLINE TRANSISTOR



LAND PATTERN EXAMPLE
SCALE:15X



SOLDER MASK DETAILS

4214838/C 04/2017

NOTES: (continued)

4. Publication IPC-7351 may have alternate designs.
5. Solder mask tolerances between and around signal pads can vary based on board fabrication site.

EXAMPLE STENCIL DESIGN

DBZ0003A

SOT-23 - 1.12 mm max height

SMALL OUTLINE TRANSISTOR



SOLDER PASTE EXAMPLE
BASED ON 0.125 THICK STENCIL
SCALE:15X

4214838/C 04/2017

NOTES: (continued)

6. Laser cutting apertures with trapezoidal walls and rounded corners may offer better paste release. IPC-7525 may have alternate design recommendations.
7. Board assembly site may have different recommendations for stencil design.

IMPORTANT NOTICE AND DISCLAIMER

TI PROVIDES TECHNICAL AND RELIABILITY DATA (INCLUDING DATASHEETS), DESIGN RESOURCES (INCLUDING REFERENCE DESIGNS), APPLICATION OR OTHER DESIGN ADVICE, WEB TOOLS, SAFETY INFORMATION, AND OTHER RESOURCES "AS IS" AND WITH ALL FAULTS, AND DISCLAIMS ALL WARRANTIES, EXPRESS AND IMPLIED, INCLUDING WITHOUT LIMITATION ANY IMPLIED WARRANTIES OF MERCHANTABILITY, FITNESS FOR A PARTICULAR PURPOSE OR NON-INFRINGEMENT OF THIRD PARTY INTELLECTUAL PROPERTY RIGHTS.

These resources are intended for skilled developers designing with TI products. You are solely responsible for (1) selecting the appropriate TI products for your application, (2) designing, validating and testing your application, and (3) ensuring your application meets applicable standards, and any other safety, security, or other requirements. These resources are subject to change without notice. TI grants you permission to use these resources only for development of an application that uses the TI products described in the resource. Other reproduction and display of these resources is prohibited. No license is granted to any other TI intellectual property right or to any third party intellectual property right. TI disclaims responsibility for, and you will fully indemnify TI and its representatives against, any claims, damages, costs, losses, and liabilities arising out of your use of these resources.

TI's products are provided subject to TI's Terms of Sale (www.ti.com/legal/termsofsale.html) or other applicable terms available either on ti.com or provided in conjunction with such TI products. TI's provision of these resources does not expand or otherwise alter TI's applicable warranties or warranty disclaimers for TI products.

Mailing Address: Texas Instruments, Post Office Box 655303, Dallas, Texas 75265
Copyright © 2020, Texas Instruments Incorporated